

**PZ4000**  
**Power Analyzer**

**USER'S MANUAL**

---

# Product Registration

Thank you for purchasing YOKOGAWA products.

YOKOGAWA provides registered users with a variety of information and services.

Please allow us to serve you best by completing the product registration form accessible from our homepage.

<http://www.yokogawa.com/tm/>

---

Thank you for purchasing the YOKOGAWA PZ4000 Power Analyzer.

This User's Manual contains useful information about the precautions, functions, and operating procedures of the instrument. To ensure correct use, please read this manual thoroughly before operation.

Keep this manual in a safe place for quick reference in the event a question arises.

The following two manuals, including this one, are provided as manuals for the PZ4000.

Manual Name	Manual No.	Description
PZ4000 Power Analyzer User's Manual	IM 253710-01E	This manual. Explains all functions and procedures of the PZ4000 excluding the communication functions.
PZ4000 Power Analyzer Communication Interface User's Manual	IM 253710-11E	Explains the communication functions of the GP-IB and serial interfaces.

## Notes

- The contents of this manual are subject to change without prior notice as a result of continuing improvements to the instrument's performance and functions. The figures given in this manual may differ from the actual screen.
- Every effort has been made in the preparation of this manual to ensure the accuracy of its contents. However, should you have any questions or find any errors, please contact your nearest YOKOGAWA dealer.
- Copying or reproducing all or any part of the contents of this manual without YOKOGAWA's permission is strictly prohibited.

## Trademarks

- MS-DOS is a registered trademark of Microsoft Corporation.
- PostScript is a registered trademark of Adobe Systems Incorporated.
- Other company and product names are trademarks or registered trademarks of their respective holders.

## Revisions

- 1st edition: April 1999
- 2nd edition: April 2000

# Checking the Contents of the Package

Unpack the box and check the contents before operating the instrument. If some of the contents are not correct or missing or if there is physical damage, contact the dealer from which you purchased them.

## PZ4000 Main Unit

Check that the model name and suffix code given on the name plate on the side panel match those on the order.

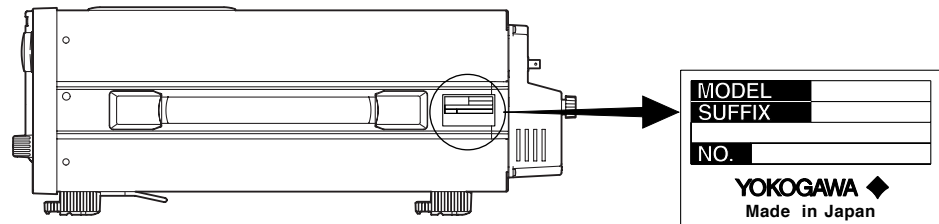

### MODEL and SUFFIX codes

Model Code	Suffix Code	Specifications
253710		100 to 120 / 200 to 240 VAC The input module is not included with the main unit. For information on the input module, see page iii.
Power cord	-D	UL/CSA Standard Power Cord (Part No. : A1006WD) [Maximum rated voltage : 125 V, Maximum rated current : 7 A]
	-F	VDE Standard Power Cord (Part No. : A1009WD) [Maximum rated voltage : 250 V, Maximum rated current : 10 A]
	-Q	BS Standard Power Cord (Part No. : A1054WD) [Maximum rated voltage : 250 V, Maximum rated current : 10 A]
	-R	SAA Standard Power Cord (Part No. : A1024WD) [Maximum rated voltage : 240 V, Maximum rated current : 10 A]
Options	/M1	Extend memory to 1 Mword/CH*
	/M3	Extend memory to 4 Mword/CH*
	/B5	Built-in printer
	/C7	SCSI

\* Only one of the options, /M1 or /M3, can be selected.

Ex : For UL/CSA standard power cord, 4 Mword/CH memory extension, built-in printer, and SCSI : 253710-D/M3/B5/C7

### NO. (Instrument No.)

When contacting the dealer from which you purchased the instrument, please quote the instrument No.

### Standard Accessories for the PZ4000

The following standard accessories are supplied with the instrument.

Part Name	Part Number	Q'ty	Notes
1. Power cord	See previous page	1	–
2. Spare power fuse	A1354EF	1	250 V, 6.3 A, time lag (Attached to the fuse holder)
3. Printer roll paper	B9850NX	1	For the built-in printer (Only provided with option /B5.)
4. Rubber feet	A9088ZM	2	Two pieces in one set. Two sets provided.
5. Cover plate	B9315DC	4	Attach cover plates on unused slots using screws (see item 7).
6. Current input protective cover	B9315DJ	1	–
7. Screw	Y9305LB	20	M3, length: 5 mm (for fixing cover plates and current input protective covers in place)
8. • User's Manual • Communication Interface User's Manual	IM253710-01E IM253710-11E	1 1	This manual –

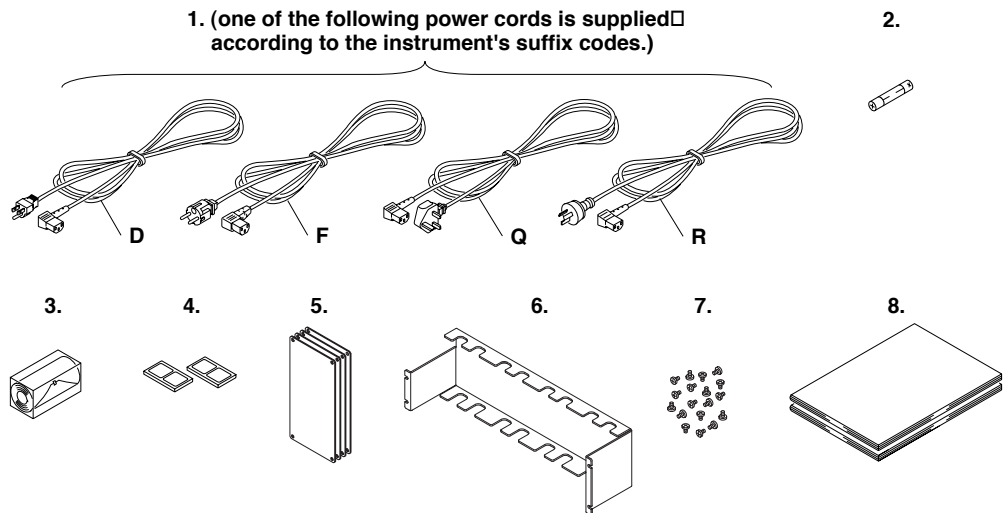

## Checking the Contents of the Package

### Input Module (Sold Separately)

Check that the model name given on the name plate on the input module matches that on the order.

#### Power measurement module

Model Code	Suffix Code	Specifications
253751		Voltage 1000 V / current 5 A / current sensor 500 mV
253752		Voltage 1000 V / current 5 A & 20 A / current sensor 500 mV
Module specification	-E1	Plug-in unit

\* Install the power measurement modules in order, starting with the slot for element 1.

#### Sensor input module\*1

Model Code	Suffix Code	Specifications
253771*2		Motor module, 2 channel input. Allows signals to be input from revolution sensor or torque meter.
Module specification	-E1	Plug-in unit

\*1 Install the sensor input module into the element 4 slot.

\*2 This is applicable to products (PZ4000) with firmware version 2.01 or later.

Ex : For a power measurement module with Voltage 1000 V / current 5 A / current sensor 500 mV : 253751-E1

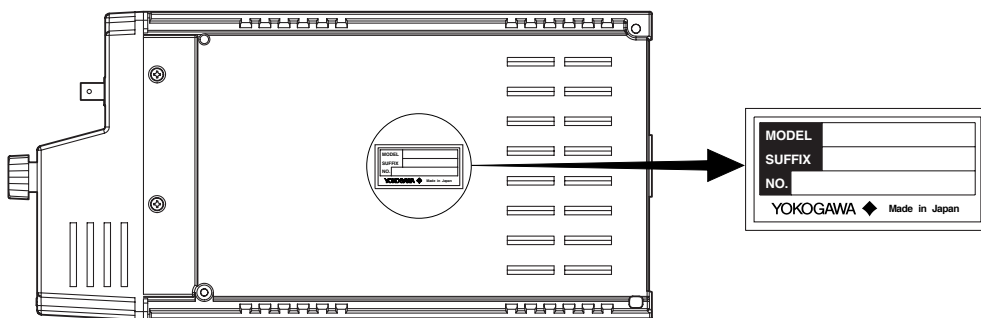

### Standard Accessories for the Input Module

The following standard accessories are supplied with the input module.

Part Name	Part Number	Q'ty	Notes
External sensor cable	B9284LK	1	Provided with the 253751 and 253752



### Optional Accessories (Sold Separately)

The following optional accessories are available for purchase separately.

Part Name	Part Number	Q'ty	Notes
1. Serial port adapter	366971	1	9 pin <sup>*1</sup> -to-25 pin <sup>*2</sup> adapter *1 EIA-574 Standard *2 EIA-232 Standard (RS-232)
2. BNC-alligator clip measurement lead	366926	1	42 V or less, length 1 m
3. BNC-BNC measurement lead	366924	1	42 V or less, length 1 m
4. Measurement lead	758917	1	Two leads in one set, used with the separately sold adapter 758922 or 758929, length 0.75 m, ratings 1000 Vrms
5. Alligator clip adapter set	758922	1	Two pieces in one set, for the measurement lead 758917. Rated voltage 300 V
6. Alligator clip adapter set	758929	1	Two pieces in one set, for the measurement lead 758917. Rated voltage 1000 V
7. Fork terminal adapter set	758921	1	Two pieces in one set, for the measurement lead 758917. Rated current 25 A

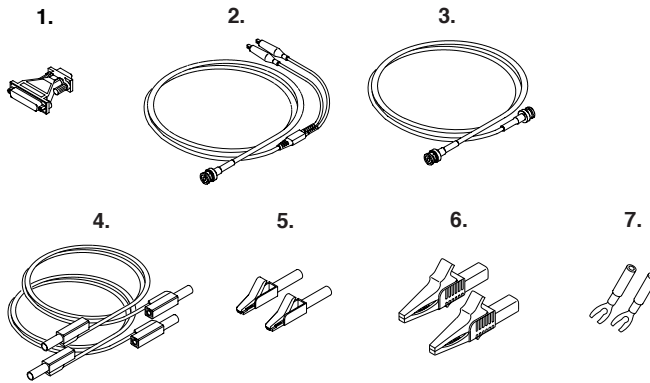

### Spare Parts (Sold Separately)

The following spare parts are available.

Part Name	Part Number	Q'ty	Notes
1. Printer roll paper	B9850NX	5	One roll is one set, thermal-sensitive paper, total length 30 m
2. Power fuse	A1354EF	2	250 V, 6.3 A, time lag

#### Note

We recommend you keep the packing box. The box is useful when you need to transport the instrument.

---

# Safety Precautions

This instrument is an IEC safety class I instrument (provided with terminal for protective earth grounding).

The following general safety precautions must be observed during all phases of operation. If the instrument is used in a manner not specified in this manual, the protection provided by the instrument may be impaired. YOKOGAWA Electric Corporation assumes no liability for the customer's failure to comply with these requirements.

## The following symbols are used on this instrument.

 "Handle with care." To avoid injury, death of personnel or damage to the instrument, the operator must refer to the explanation in the User's Manual or Service Manual.

 Alternating current

 Both direct and alternating current

 ON (power)

 OFF (power)

 In-position of a bistable push control

 Out-position of a bistable push control



**Make sure to comply with the following safety precautions. Not complying might result in injury, death of personnel.**

---

**WARNING**

**Power Supply**

Ensure that the source voltage matches the voltage of the power supply before turning ON the power.

**Power Cord and Plug**

To prevent an electric shock or fire, be sure to use the power cord supplied by YOKOGAWA. The main power plug must be plugged into an outlet with a protective earth terminal. Do not invalidate protection by using an extension cord without protective grounding.

**Protective Grounding**

Make sure to connect the protective grounding to prevent electric shock before turning ON the power.

**Necessity of Protective Grounding**

Never cut off the internal or external protective earth wire or disconnect the wiring of the protective earth terminal. Doing so poses a potential shock hazard.

**Defect of Protective Grounding and Fuse**

Do not operate the instrument when the protective earth or the fuse might be defective. Also, make sure to check them before operation.

**Fuse**

To prevent fire, only use a fuse that has a rating (voltage, current, and type) that is specified by the instrument. When replacing a fuse, turn OFF the power switch and unplug the power cord. Never short the fuse holder.

**Do Not Operate in Explosive Atmosphere**

Do not operate the instrument in the presence of flammable liquids or vapors. Operation of any electrical instrument in such an environment constitutes a safety hazard.

**Do Not Remove Covers**

Some areas inside the instrument have high voltages. Do not remove the cover if the power supply is connected. The cover should be removed by YOKOGAWA's qualified personnel only.

**External Connection**

Connect the protective grounding before connecting to the item under measurement or control unit.

---

---

# How to Use this Manual

## Structure of the Manual

This User's Manual consists of the following 16 chapters, an appendix, and an index.

---

### Chapter 1 Functions

Describes the functions of the instrument. Operating procedures are not given in this chapter. However, reading this chapter will help you understand the operating procedures given in the chapters that follow.

---

### Chapter 2 Names and Uses of Parts

Describes the names and uses of each part of the instrument.

---

### Chapter 3 Before Starting Measurements

Describes precautions for the use of the instrument, how to install the instrument, how to install the input module, how to connect the power supply, how to wire measurement circuits, how to turn ON/OFF the power switch, and other preparations before starting measurements.

---

### Chapter 4 Common Operations

Describes common operations and functions of the instrument such as how to enter numerical values and strings, initialize settings, start/stop the measurement acquisition, perform zero-level compensation, and the NULL function.

---

### Chapter 5 Setting the Measurement Mode and Range

Describes how to set the voltage/current input conditions or the handling of the input signal such as the measurement mode (select normal/harmonics), the wiring system, the measurement range, and filter.

---

### Chapter 6 Setting the Time Axis

Describes how to set the input conditions for the time axis such as the observation time and record length.

---

### Chapter 7 Setting the Trigger

Describes how to set the trigger which determines the timing of the voltage/current signals acquisition.

---

### Chapter 8 Numerical Display

Describes how to display measurement function data (numerical data).

---

### Chapter 9 Waveform Display

Describes how to display the waveforms of the voltage and current signals.

---

### Chapter 10 Numerical Computations

Describes how to set numerical computations such as the delta computation, user definitions, and averaging.

---

### Chapter 11 Waveform Analysis

Describes how to set waveform computations such as FFTs and cursor measurements.

---

### Chapter 12 Saving and Loading the Data

Describes how to save and load numerical and waveform data from the instrument.

---

### Chapter 13 Outputting Screen Image Data

Describes how to output the screen image data.

---

### Chapter 14 External Trigger Output and Other Operations

Describes how to set the external trigger output function, message language, and display color.

---

### Chapter 15 Motor Evaluation Function (Applicable to Motor Modules)

Describes how to set the instrument in order to determine various motor characteristics by inputting signals from revolution sensor and torque meter.

---

### Chapter 16 Troubleshooting, Maintenance, and Inspection

Describes the possible causes of problems and their appropriate corrective measures. Describes the messages that are displayed on the screen. Describes maintenance and inspection issues such as how to perform self-tests and replace power fuses.

---

### Chapter 17 Specifications

Describes the specifications of the main unit and of the input module in tables.

---

### Appendix

Describes the relationship between the observation time, sampling rate, and record length, how to determine the measurement function and delta computation, and the ASCII header file format. Gives a list of initial settings.

---

### Index

Alphabetic and Symbol index of contents.

---

## Conventions Used in this Manual

### Unit

k .... Denotes 1000. Example : 15 kg, 100 kS/s

K .... Denotes 1024. Example : 720 KB (Storage capacity of floppy disks)

### Displayed characters

Alphanumeric characters enclosed with [ ] refer to characters or setting values that are displayed on the screen.

SHIFT+operation key means that the SHIFT key should be pressed so that the indicator on the top left of the SHIFT key lights followed by the pressing of the operation key. The menu written below the pressed operation key is displayed.

### Symbols

The following symbols are used in this manual.



Affixed to the instrument. Indicates danger to personnel or instrument and the operator must refer to the User's Manual. The symbol is used in the User's Manual to indicate the reference.

### **WARNING**

Describes precautions that should be observed to prevent injury or death to the user.

### **CAUTION**

Describes precautions that should be observed to prevent minor or moderate injury, or damage to the instrument.

### **Note**

Provides important information for the proper operation of the instrument.

### Symbols used on pages describing operating procedures

On pages that describe the operating procedures in Chapter 3 through 16, the following symbols are used to distinguish the procedures from their explanations.

### **Keys**

Indicates the key related to the operation.

### **Procedure**

Follow the steps indicated with numbers. The procedures are given with the premise that the user is carrying out the steps for the first time. Depending on the operation, not all steps need to be taken.

### **Explanation**

This section describes the setting parameters and the limitations regarding the procedures. It does not give a detailed explanation of the function. For details on the function, see chapter 1.

---

# Contents

Checking the Contents of the Package .....	ii
Safety Precautions .....	vi
How to Use this Manual .....	viii

## Chapter 1 Functions

1.1	System Configuration and Block Diagram .....	1-1
	System Configuration .....	1-1
	Block diagram .....	1-2
	Signal Flow and Process .....	1-3
1.2	Measurement Modes and Measurement/Computation Periods .....	1-5
	Normal Measurement Mode and Measurement Function (Types of Numerical Data) .....	1-5
	Harmonic Measurement Mode and Measurement Function (Types of Numerical Data) .....	1-7
	Measurement/Computation Period .....	1-10
	Wiring Method, Number of Displayed Digits .....	1-11
1.3	Acquiring Data (Voltage and Current Signals) .....	1-12
	Sampled Data, Input module, Element and Channel .....	1-12
	Measurement Range of Voltage, Current, and Power, Scaling .....	1-13
	Input Filter (Line Filter and Zero Crossing Filter) .....	1-14
	Observation Time, Record length .....	1-15
	Dividing the record length, Time Base .....	1-16
	Zero Level Compensation, NULL Function .....	1-17
1.4	Trigger .....	1-18
	Trigger Source, Trigger Slope, Trigger Level, Trigger Type .....	1-18
	Trigger Mode .....	1-19
	Trigger Position, Trigger Delay .....	1-21
1.5	Numerical Display .....	1-22
	Numerical display during the normal measurement mode .....	1-22
	Numerical display during the harmonic measurement mode .....	1-23
	Resetting the Numerical Display .....	1-25
1.6	Waveform Display .....	1-26
	Vertical (Amplitude) Axis and Horizontal (Time) Axis .....	1-26
	Turning ON/OFF the Waveform Display, Vertical Position of the Waveform, Split Screen of the Waveform, Display Interpolation of the Waveform .....	1-28
	Zooming on the Waveform .....	1-29
	Vector Display of Harmonics .....	1-31
	Bar Graph Display of the Harmonic Data, X-Y Waveform Display .....	1-32
	Other Display Settings .....	1-33
1.7	Numerical Computation .....	1-34
	Delta Computation, User-defined Functions, Equation for the Apparent Power .....	1-34
	Averaging, Phase Difference .....	1-35
	Equation for the Distortion Factor, Corrected Power, Re-computing the numerical data .....	1-36
1.8	Waveform Analysis .....	1-37
	Waveform Computation .....	1-37
	Display Scaling of a Computed Waveform .....	1-39
	FFT .....	1-40
	Re-computing the Waveform, Cursor measurements .....	1-41

1.9	Saving/Loading the Data and Other Useful Functions .....	1-42
	Saving/Loading data from a Floppy Disk, Saving/Loading from a SCSI Device, Initialization, Outputting Screen Image Data .....	1-42
	Selecting the Message Language, Setting the Brightness of the LCD monitor, Setting the Display Colors, Action-on-Trigger, Self-test Function, Confirming the System Condition of the Instrument, Communication Function (GP-IB/Serial) .....	1-43
<b>Chapter 2 Names and Uses of Parts</b>		
2.1	Front Panel, Rear Panel, and Top View .....	2-1
2.2	Operation Keys, Jog Shuttle, and Rotary Knob .....	2-3
2.3	Screens .....	2-6
2.4	Input Modules .....	2-14
<b>Chapter 3 Before Starting Measurements</b>		
3.1	Precautions on the Use of the instrument .....	3-1
3.2	Installing the Instrument .....	3-2
△ 3.3	Installing the Input Module .....	3-4
△ 3.4	Wiring Precautions .....	3-6
3.5	For Making Accurate Measurements .....	3-8
△ 3.6	Connecting the Power Supply .....	3-10
3.7	Directly Wiring the Circuit under Measurement .....	3-11
	(Wiring to the voltage/current input terminal of the power measurement module.)	
3.8	Using an External Current Sensor to Wire the Circuit under Measurement .....	3-15
	(Wiring to the current sensor input connector of the power measurement module.)	
3.9	Using an External PT or CT to Wire the Circuit under Measurement .....	3-19
	(Wiring to the voltage/current input terminal of the power measurement module.)	
△ 3.10	Wiring a Circuit with Voltage Input Exceeding 600 V .....	3-22
3.11	Turning ON/OFF the Power Switch .....	3-23
3.12	Setting the Date and Time .....	3-25
<b>Chapter 4 Common Operations</b>		
4.1	Entering Values and Strings .....	4-1
4.2	Initializing the Settings .....	4-3
4.3	Starting/Stopping Data Acquisition .....	4-4
4.4	Performing Zero-level Compensation .....	4-6
4.5	Using the NULL Function .....	4-7
4.6	Using the Help Function .....	4-8
<b>Chapter 5 Setting the Measurement Mode and Range</b>		
5.1	Selecting the Measurement Mode .....	5-1
5.2	Selecting the Wiring Method .....	5-2
5.3	Setting the Measurement Range during Direct Input .....	5-6
5.4	Setting the Measurement Range when Using an External Current Sensor .....	5-14
5.5	Setting the Scaling Function when using an External PT or CT .....	5-20
5.6	Selecting the Input Filter .....	5-25

1

2

3

4

5

6

7

8

9

10

11

12

13

14

15

16

17

App

Index

**Chapter 6 Setting the Time Axis**

6.1 Setting the Observation Time ..... 6-1  
 6.2 Selecting the Record Length for Acquiring Data ..... 6-3  
 △ 6.3 Selecting the Time Base ..... 6-5

**The following section applies when the measurement mode is set to harmonic measurement.**

△ 6.4 Selecting the PLL Source for Harmonic Measurement ..... 6-7

**Chapter 7 Setting the Trigger**

7.1 Selecting the Trigger Mode ..... 7-1  
 △ 7.2 Selecting the Trigger Source ..... 7-3  
 7.3 Setting the Edge Trigger ..... 7-6  
 7.4 Setting the Window Trigger ..... 7-8  
 7.5 Setting the Trigger Position ..... 7-11  
 7.6 Setting the Trigger Delay ..... 7-13

**Chapter 8 Numerical Display**

8.1 Selecting the Number of Displayed Digits ..... 8-1  
 8.2 Displaying Normal Measurement Data ..... 8-2  
 8.3 Changing the Displayed Items of the Normal Measurement Data ..... 8-8

**The following sections apply when the measurement mode is set to harmonic measurement.**

8.4 Displaying Harmonic Measurement Data ..... 8-11  
 8.5 Changing the Displayed Items of the Harmonic Measurement Data ..... 8-19

**Chapter 9 Waveform Display**

9.1 Selecting the Channel to Display ..... 9-1  
 9.2 Moving the Vertical Position ..... 9-5  
 9.3 Splitting the Screen and Displaying the Waveforms ..... 9-7  
 9.4 Interpolating the Display ..... 9-10  
 9.5 Changing the Graticule ..... 9-12  
 9.6 Turning ON/OFF the scale display ..... 9-14  
 9.7 Setting a Label Name for the Waveform ..... 9-16  
 9.8 Zooming on the Waveform ..... 9-18

**The following sections apply when the measurement mode is set to harmonic measurement.**

9.9 Displaying the Vectors of the Harmonics ..... 9-24  
 9.10 Displaying the Bar Graph of Harmonic Data ..... 9-27  
 9.11 Displaying the X-Y Waveform ..... 9-32

**Chapter 10 Numerical Computations**

10.1 Setting the Measurement/Computation Period, Re-computing ..... 10-1

10.2 Selecting the Delta Computation ..... 10-8

10.3 Setting the User-Defined Function ..... 10-11

10.4 Setting the Equations for Apparent Power and Corrected Power ..... 10-15

10.5 Averaging ..... 10-18

10.6 Selecting the Display Format of the Phase Difference ..... 10-20

**The following sections apply when the measurement mode is set to harmonic measurement.**

10.7 Setting the Harmonic Orders under Analysis ..... 10-22

10.8 Selecting the Equation for the Distortion Factor ..... 10-24

**Chapter 11 Waveform Analysis**

11.1 Setting the Computation Region, Re-computing ..... 11-1

11.2 Setting the Equation, Converting the Scale of the Computed Waveform ..... 11-4

11.3 Performing the FFT ..... 11-8

11.4 Measuring with the Cursor ..... 11-10

**Chapter 12 Saving and Loading the Data**

12.1 Precautions on the Use of the Floppy Drive ..... 12-1

12.2 Connecting SCSI Devices ..... 12-2

12.3 Changing the SCSI ID Number ..... 12-3

12.4 Formatting the Disk ..... 12-5

12.5 Saving and Loading Setup Parameters ..... 12-10

12.6 Saving and Loading Waveform Data ..... 12-16

12.7 Saving Numerical Data ..... 12-22

12.8 Changing the File Attribute, Deleting Files ..... 12-28

12.9 Copying Files ..... 12-33

12.10 Changing the Directory/File Name, Creating a Directory ..... 12-37

**Chapter 13 Outputting Screen Image Data**

13.1 Installing the Paper Roll into the Built-in Printer (Option), Paper Feeding ..... 13-1

13.2 Printing to the Built-in Printer (Option) ..... 13-5

⚠ 13.3 Printing to an External Centronics Printer ..... 13-8

13.4 Saving Screen Images to Floppy Disk and SCSI Device ..... 13-11

**Chapter 14 External Trigger Output and Other Operations**

⚠ 14.1 External Trigger Output ..... 14-1

14.2 Selecting the Message Language/Setting the Brightness of the Screen ..... 14-2

14.3 Setting the Display Colors of the Screen ..... 14-4

14.4 Setting the Action-on-Trigger ..... 14-8

1

2

3

4

5

6

7

8

9

10

11

12

13

14

15

16

17

App

Index

## Chapter 15 Motor Evaluation Function (Applicable to Motor Modules)

15.1	Inputting Signals of rotating speed and Torque .....	15-1
15.2	Setting the Input Range of Revolution Sensor and Torque Meter Signals .....	15-3
15.3	Selecting the Input Filter .....	15-9
15.4	Setting the Scaling Factor, the Pulse Count, and Unit Used to Measure the rotating speed .....	15-11
15.5	Setting the Scaling Factor and Unit Used to Measure the Torque .....	15-14
15.6	Setting the Motor's Number of Poles Used to Compute the Synchronous Speed and the Slip .....	15-16
15.7	Setting the Scaling Factor and Unit Used to Compute the Motor Output .....	15-18
15.8	Computing the Motor Efficiency and Total Efficiency .....	15-20

## Chapter 16 Troubleshooting, Maintenance, and Inspection

16.1	Troubleshooting .....	16-1
16.2	Error Messages and Corrective Actions .....	16-2
16.3	Performing a Self-test .....	16-5
16.4	Checking the System Conditions .....	16-8
△ 16.5	Replacing the Power Fuse .....	16-9
16.6	Recommended Replacement Parts .....	16-10

## Chapter 17 Specifications

17.1	Input .....	17-1
17.2	Display .....	17-1
17.3	Time Axis .....	17-1
17.4	Measurement Function (Measurement Item) .....	17-2
17.5	Functions .....	17-6
	Measurement Mode and Wiring Method, Data Acquisition, Frequency Measurement ..	17-6
	Trigger, Numerical Display, Waveform Display .....	17-7
	Vector/Bar Graph Displays, Simultaneous display, Numerical computation, Waveform Analysis .....	17-8
	Harmonic Measurement, Save and Load data, Output Screen Image Data .....	17-9
17.6	External Trigger I/O Section .....	17-10
17.7	Internal Floppy Disk Drive .....	17-10
17.8	GP-IB Interface .....	17-10
17.9	Serial (RS-232) Interface .....	17-11
17.10	Centronics Interface .....	17-11
17.11	SCSI (Option) .....	17-11
17.12	Built-in Printer (Option) .....	17-11
17.13	General Specifications .....	17-12
17.14	External Dimensions (253710) .....	17-14
17.15	Power Measurement Module (253751) .....	17-15
17.16	Power Measurement Module (253752) .....	17-20
17.17	Motor Module (253771) .....	17-25

## Appendix

App 1	Relationship between the Observation Time, Sampling Rate, and Record length .....	App-1
App 2	Symbols and Determination of Measurement Functions .....	App-4
App 3	Determination of Delta Computation .....	App-8
App 4	List of Initial Settings and Display Order of Numerical Data .....	App-10
App 5	ASCII Header File Format .....	App-16
App 6	Float File Format .....	App-20
App 7	Power Basics (Power/Harmonics/Three Constants Related to the AC Circuit) .....	App-25

## Index



# 1.1 System Configuration and Block Diagram

## System Configuration

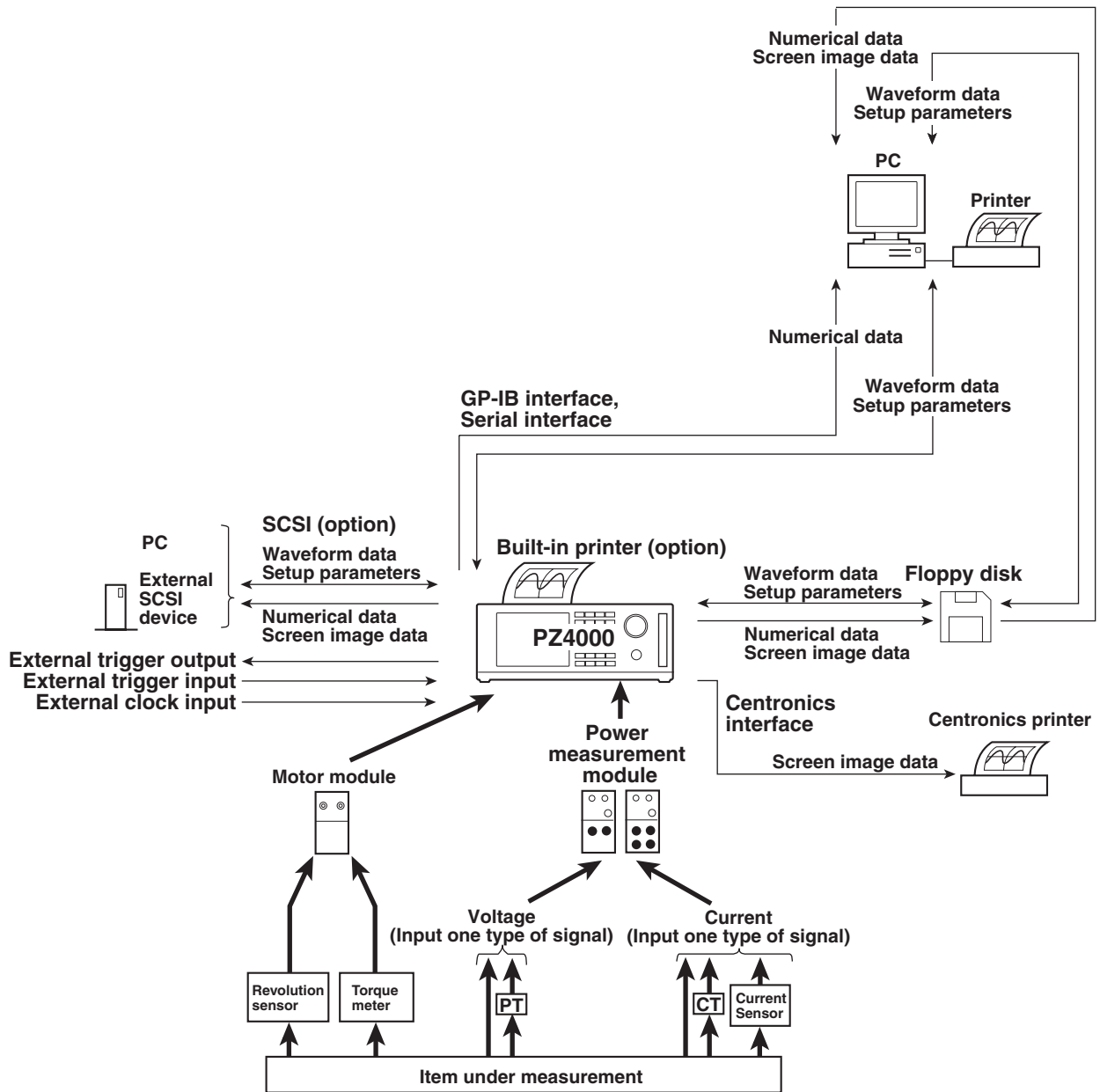

Complies with EIA-574 Standard (EIA-232 (RS-232) Standard for 9 pin)

1.1 System Configuration and Block Diagram

Block diagram

Power measurement module Model : 253751 / 253752

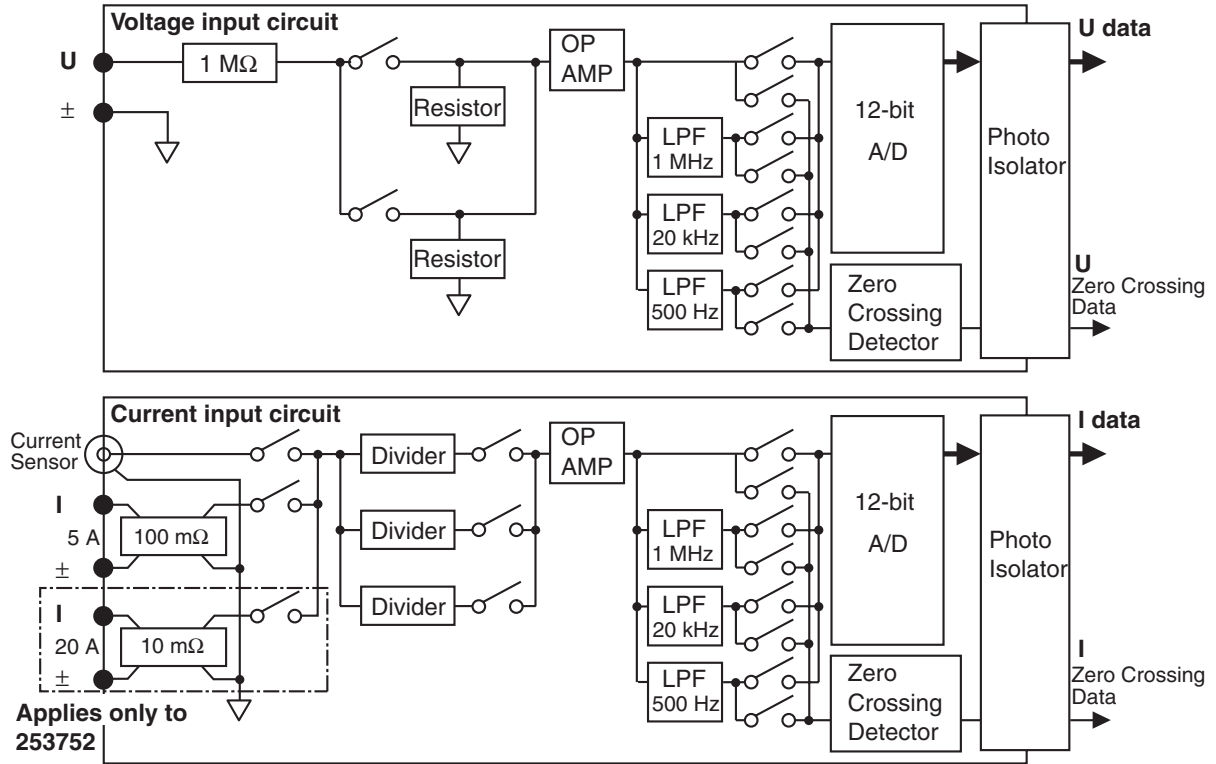

Motor module Model: 253771

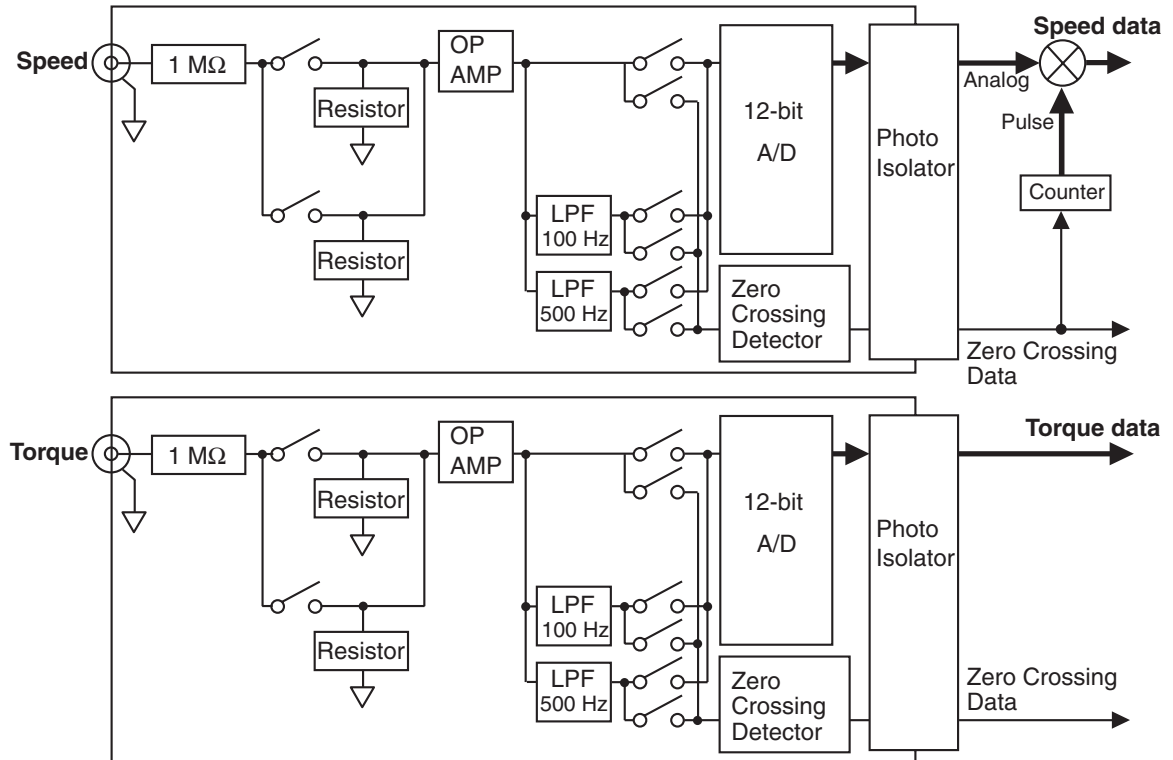

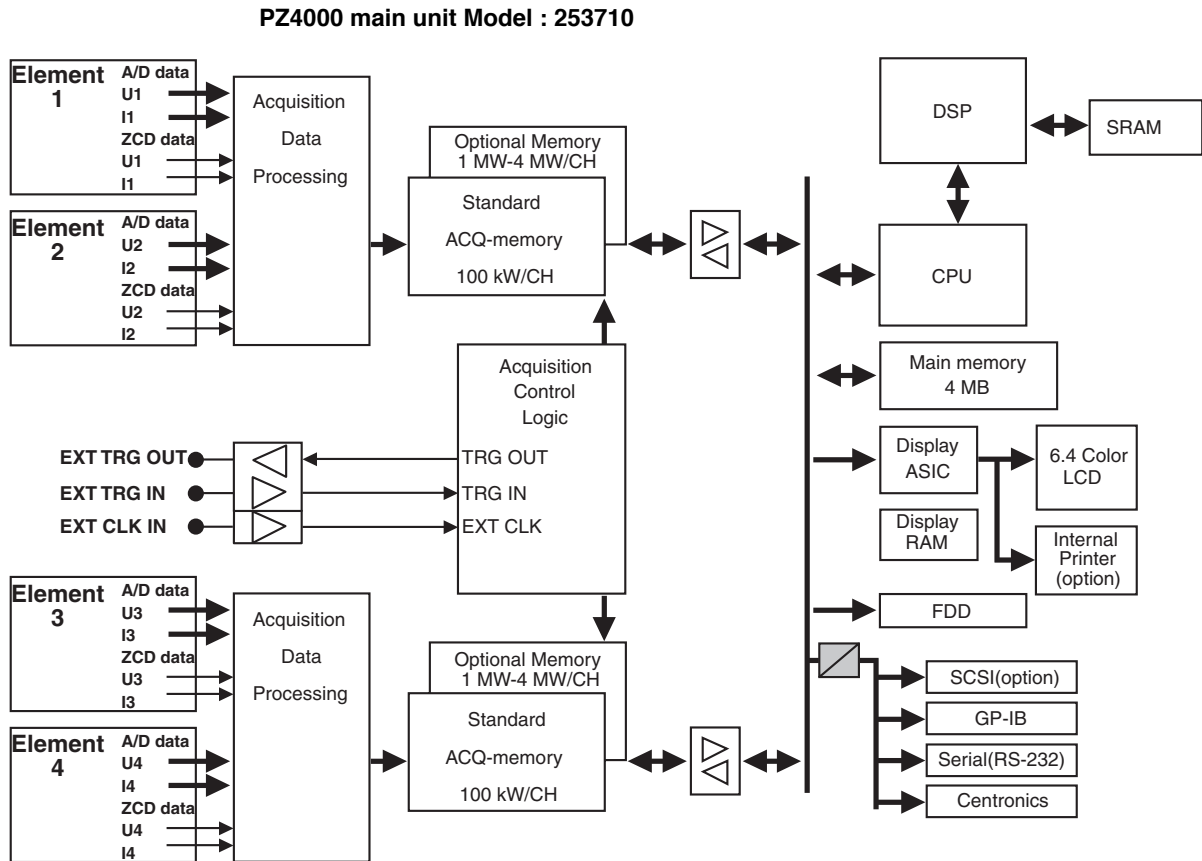

## Signal Flow and Process

### Power measurement module Model : 253751 / 253752

A voltage signal that is applied to the voltage input terminal (U,  $\pm$ ) of the power measurement module is normalized using the voltage divider of the input circuit and an operational amplifier (OP AMP). It is then input to the A/D converter and the zero crossing detector.

There are two ways in which current signals can be input to the 253751. One way utilizes a current sensor input connector (Current Sensor) that inputs voltage signals from an external current sensor. The other way utilizes a current input terminal (I,  $\pm$ ) which is used to directly input the current signal. (There are three systems on the 253752, two current input terminals and one current sensor.) For current sensor input, the input voltage is normalized using the voltage divider and OP amp. For the direct input, the signal applied to the current input terminal is converted to voltage using a current divider and then is normalized in the same manner as the current sensor input. The normalized voltage is then input to an A/D converter and zero crossing detector of the same type and configuration as those to which voltage signals are sent.

The A/D converter samples the voltage/current input signals using the sampling clock provided by the internal circuit of the 253710, converting the signals to digital data. The sampling rate is fixed to 5 MS/s for the normal measurement mode, and integer multiples of the PLL source\* for the harmonic measurement mode (approx. 80 k to 160 kS/s). The sampling operation can also be carried out using a clock signal that is applied to the external clock input connector.

\* When measuring harmonics, the fundamental frequency must be determined in order to analyze the higher orders. The PLL (phase locked loop) source is the signal that is used to determine the fundamental frequency.

## 1.1 System Configuration and Block Diagram

---

### Motor module Model: 253771

The signal applied to the revolution sensor signal input connector (CH7) and the torque meter signal input connector (CH8) of the motor module is normalized using the voltage divider and the operational amplifier (OP AMP). The voltage is then input to the A/D converter and the zero crossing detector.

- **When the signal from the revolution sensor and torque meter is a DC voltage (analog input)**

The A/D converter samples the voltage/current input signals using the sampling clock provided by the internal circuit of the 253710, converting the signals to digital data. The sampling rate is fixed to 5 MS/s for the normal measurement mode, and integer multiples of the PLL source for the harmonic measurement mode (approx. 80 k to 160 kS/s). The sampling operation can also be carried out using a clock signal that is applied to the external clock input connector.

- **When the signal from the revolution sensor is a pulse signal**

A count value is output in place of digital data of the A/D converter. The counter counts the signal that is output by the zero crossing detector from the rising edge to the falling edge (one period) using the reference clock (internal clock) and updates the count value.

### PZ4000 main unit Model : 253710

The output from the A/D converter and the zero crossing detector of the module is passed to the main unit of the 253751 via the photo isolator. Up to eight channels of sampled data and zero crossing data are recorded into the acquisition memory (ACQ memory) along with the external trigger and external clock conditions according to the sampling rate that is automatically determined by the specified observation time (see page 1-14).

The digital signal processor (DSP) determines the voltage, current, and active power (also reactive power for harmonic measurement mode) from the sampled data in the acquisition memory. The display ASIC processes the numerical and waveform data so that they can be displayed.

In order to accurately determine the basic measurement items for currents (voltage, current, active power (also reactive power for harmonic measurement mode)), the sampled data must be averaged over a period in sync with the period of the input signal. To do so, the DSP uses the zero crossing data and external clock and external trigger conditions.

In addition, the DSP calculates additional items from the basic measurement items. Among these additional items are the apparent power, the reactive power (for normal measurement mode), the power factor, phase difference, impedance, and  $\Sigma$ .

## 1.2 Measurement Modes and Measurement/Computation Periods

There are two measurement modes, normal measurement and harmonic measurement.

### Normal Measurement Mode and Measurement Function (Types of Numerical Data)

«For procedures, see section 5.1.»

The data specified by the measurement function (numerical data) in the normal measurement mode are measured or computed over the specified period of the sampled data\* as described later in "Measurement/Computation Period."

\* For information on the sampled data, see section 1.3 "Acquiring Data (Voltage and Current Signals)."

#### Measurement function (types of numerical data)

- **Measurement function on each power measurement module**

The following 29 types of numerical data can be determined. For details related to the determination of measurement function data, see "Appendix 2."

U (voltage  $U_{rms}$ ,  $U_{mn}$ ,  $U_{dc}$ ,  $U_{ac}$ ), I (current  $I_{rms}$ ,  $I_{mn}$ ,  $I_{ac}$ ), P (active power), S (apparent power), Q (reactive power),  $\lambda$  (power factor),  $\phi$  (phase difference),  $f_U/f_I$  (frequency of voltage/current),  $U_{+pk}/U_{-pk}$  (maximum/minimum values of voltage),  $I_{+pk}/I_{-pk}$  (maximum/minimum values of current),  $Cf_U/Cf_I$  (crest factor of voltage/current),  $Ff_U/Ff_I$  (form factor of voltage/current), Z (impedance of the load circuit),  $R_s/X_s$  (resistance/reactance of the load circuit that has a resistor R, inductor L, and capacitor C connected in series),  $R_p/X_p$  (resistance/reactance of the load circuit that has a R, L, and C connected in parallel),  $P_c$  (Corrected Power)

- **Measurement function of the average or sum of multiple measurement modules ( $\Sigma$ function)**

The following 19 types of numerical data can be determined. For details related to the determination of measurement function data, see "Appendix 2."

$U_{\Sigma}$  (voltage average  $U_{rms\Sigma}$ ,  $U_{mn\Sigma}$ ,  $U_{dc\Sigma}$ ,  $U_{ac\Sigma}$ ),  $I_{\Sigma}$  (current average  $I_{rms\Sigma}$ ,  $I_{mn\Sigma}$ ,  $I_{dc\Sigma}$ ,  $I_{ac\Sigma}$ ),  $P_{\Sigma}$  (sum of active powers),  $S_{\Sigma}$  (sum of apparent powers),  $Q_{\Sigma}$  (sum of reactive powers),  $\lambda_{\Sigma}$  (power factor average),  $\phi_{\Sigma}$  (phase difference average),  $Z_{\Sigma}$  (impedance average of the load circuit),  $R_{s\Sigma}/X_{s\Sigma}$  (average of the resistance/reactance of the load circuit that has a R, L, and C connected in series),  $R_{p\Sigma}/X_{p\Sigma}$  (average of the resistance/reactance of the load circuit that has a R, L, and C connected in parallel),  $P_{c\Sigma}$  (sum of Corrected Powers)

- **Efficiency ( $\Sigma$ function)**

$\eta$  (Efficiency 1),  $1/\eta$  (Efficiency 2). See "Efficiency" on the next page.

- **Measurement function of the motor module**

The following seven types of numerical data can be determined. For details related to the determination of measurement function data, see "Chapter 15."

Speed (rotating speed), Torque, Sync (synchronous speed), Slip,  $P_m$  (motor output or mechanical power), motor efficiency ( $\eta_{mA}$  or  $\eta_{mB}$ ), total efficiency ( $\eta_{mA}$  or  $\eta_{mB}$ ).

#### Determining the voltage and current

There are four types of measurement functions for voltage (U) and current (I).

- **Urms, Irms (true rms value)**

These values are the true rms values of the voltage and current. The instantaneous values over one period are squared and averaged. Then, the rms value is determined. Let  $f(t)$  represent the input signal as a function of time and let T be the period of the signal.

$$U_{rms} \text{ or } I_{rms} = \sqrt{\frac{1}{T} \int_0^T f(t)^2 dt}$$

## 1.2 Measurement Modes and Measurement/Computation Periods

---

- **Umn, Imn (rectified mean value calibrated to the rms value)**

This function rectifies one period of the voltage or current signal, determines the average, and multiplies the result by a coefficient. The coefficient is the number that when applied to a sinusoidal input signal, gives the true rms value. When the input signal is a distorted or is a DC waveform, these values will differ from the true rms values. Let  $f(t)$  represent the input signal as a function of time and let  $T$  be the period of the signal.

$$U_{mn} \text{ or } I_{mn} = \frac{\pi}{2\sqrt{2}} \cdot \frac{1}{T} \int_0^T |f(t)| dt$$

- **Udc, Idc (simple average)**

These are the average values over one period of the voltage and current signal. This function is useful when determining the average value of a DC input signal or a DC component that is superimposed on an AC input signal.

$$U_{dc} \text{ or } I_{dc} = \frac{1}{T} \int_0^T f(t) dt$$

- **Uac, Iac (AC component)**

These are the AC components of the voltage and current. They are the rms values of the difference of the square of the true rms values of the input signal and the square of the DC component.

$$U_{ac} = \sqrt{U_{rms}^2 - U_{dc}^2}, \text{ or } I_{ac} = \sqrt{I_{rms}^2 - I_{dc}^2}$$

### Element number

When an input module is installed in a slot that is located on the rear side of the main unit, the slot combined with the input module is referred to as an element. The main unit can contain up to four elements which are numbered from one to four. On power measurement modules, one voltage and current pair can be input to each element. The element number is appended to the symbols that were defined in the earlier section, "Measurement function on each power measurement module" so that the correspondence can be seen. For example, "Urms1" represents the true rms value of the voltage of element 1.

### Wiring method

The wiring method is the method by which the signals that are input to each element are combined. Different selections are possible depending on the number of elements that have power measurement modules installed. In some cases, only one type of wiring method can be selected, while in other cases, two types of wiring methods can be selected. When two types of wiring methods are selected, "A" or "B" is appended to the symbols that were defined in the earlier section "Measurement function of the average or sum of multiple measurement modules ( $\Sigma$ function)" so that the correspondence can be seen.

For example, "Urms $\Sigma$ A" represents the true rms value of the average of the voltage of the power measurement modules that are combined using wiring method A.

### Efficiency

The  $\eta$  (efficiency 1) is determined by  $(P\Sigma B)/(P\Sigma A)$ , and  $1/\eta$  (efficiency 2) is determined by  $(P\Sigma A)/(P\Sigma B)$ .  $\eta$  is the efficiency of wiring B with respect to wiring A.  $1/\eta$  is the efficiency of wiring A with respect to wiring B.

## Harmonic Measurement Mode and Measurement Function (Types of Numerical Data)

«For procedures, see section 5.1.»

The data specified by the measurement function (numerical data) in the harmonic measurement mode are measured or computed over the specified period of the sampled data\* as described later in "Measurement/Computation Period."

\* For information on the sampled data, see section 1.3 "Acquiring Data (Voltage and Current Signals)."

### Harmonic measurement function (types of numerical data)

- **Harmonic measurement function on each power measurement module**

The following 28 types of numerical data can be determined. For details related to the determination of the measurement function, see Appendix 2.

Measurement Function	Chars and numbers inside ( )			All (No ( ))
	dc	1	k	
U( )	Yes	Yes	Yes	Yes
I( )	Yes	Yes	Yes	Yes
P( )	Yes	Yes	Yes	Yes
S( )	Yes	Yes	Yes	Yes
Q( )	Always 0	Yes	Yes	Yes
$\lambda$ ( )	Yes	Yes	Yes	Yes
$\phi$ ( )	No	Yes	Yes	No
$\phi$ U( )	No	No	Yes	No
$\phi$ I( )	No	No	Yes	No
Z( )	Yes	Yes	Yes	No
Rs( )	Yes	Yes	Yes	No
Xs( )	Yes	Yes	Yes	No
Rp( )	Yes	Yes	Yes	No
Xp( )	Yes	Yes	Yes	No
Uhdf( )	Yes	Yes	Yes	No
Ihdf( )	Yes	Yes	Yes	No
Phdf( )	Yes	Yes	Yes	No
Uthd	No	No	No	Yes
Ithd	No	No	No	Yes
Pthd	No	No	No	Yes
Uthf	No	No	No	Yes
Ithf	No	No	No	Yes
Utif	No	No	No	Yes
Itif	No	No	No	Yes
hvf	No	No	No	Yes
hcf	No	No	No	Yes
fU( )	No	No	No	Yes
fI( )	No	No	No	Yes

Yes : Numerical data exist

No : Numerical data do not exist

- Measurement functions having parentheses have the following meanings depending on the characters or numbers that are inside the parentheses
  - dc : Indicates numerical data related to the DC component.
  - 1 : Indicates numerical data related to the fundamental signal.
  - k : Indicates numerical data related to the 2nd to Nth order harmonics. N is the upper limit of the harmonic order under analysis. The upper limit is determined automatically (maximum is 500) by the frequency of the PLL source.
  - All : No parentheses are appended after the measurement function. Indicates numerical data related to all waveforms including the fundamental and the harmonics.
  - Uhdf to hcf are measurement functions that indicate characteristics that are specific to the harmonics. For details related to the determination of measurement functions, see Appendix 2.
  - Displays the frequency of the signal, fU (voltage) or fI (current), that is selected as the PLL source. The display of the signal that is not selected is shown as [--- ---] (no data).

## 1.2 Measurement Modes and Measurement/Computation Periods

- **Harmonic measurement function that indicates the phase difference ( $\phi$ ) of the voltage and current between the power measurement modules**

- $\phi U1-U2$

The phase difference of the fundamental signal of the voltage of element 2,  $U2(1)$ , with respect to the fundamental signal of the voltage of element 1,  $U1(1)$ .

- $\phi U1-U3$

The phase difference of the fundamental signal of the voltage of element 3,  $U3(1)$ , with respect to the fundamental signal of the voltage of element 1,  $U1(1)$ .

- $\phi U1-I1$

The phase difference of the fundamental signal of the current of element 1,  $I1(1)$ , with respect to the fundamental signal of the voltage of element 1,  $U1(1)$ .

- $\phi U1-I2$

The phase difference of the fundamental signal of the current of element 2,  $I2(1)$ , with respect to the fundamental signal of the voltage of element 1,  $U1(1)$ .

- $\phi U1-I3$

The phase difference of the fundamental signal of the current of element 3,  $I3(1)$ , with respect to the fundamental signal of the voltage of element 1,  $U1(1)$ .

- **Harmonic measurement function of the average or of the sum of the power measurement modules ( $\Sigma$ function)**

The following six types of numerical data can be determined. For details related to the determination of the measurement function, see Appendix 2.

Measurement Function	Chars and numbers inside ( )			All (No ( ))
	dc	1	k	
$U\Sigma( )$	Yes	Yes	Yes	Yes
$I\Sigma( )$	Yes	Yes	Yes	Yes
$P\Sigma( )$	Yes	Yes	Yes	Yes
$S\Sigma( )$	Yes	Yes	Yes	Yes
$Q\Sigma( )$	Always 0	Yes	Yes	Yes
$\lambda\Sigma( )$	Yes	Yes	Yes	Yes

Yes : Numerical data exist

- Measurement functions having parentheses have the following meanings depending on the characters or numbers that are inside the parentheses
  - dc : Indicates numerical data related to the DC component.
  - 1 : Indicates numerical data related the fundamental signal.
  - k : Indicates numerical data related to the 2nd to Nth order harmonics. N is the upper limit of the harmonic order under analysis. The upper limit is determined automatically (maximum is 500) by the frequency of the PLL source.
- All : No parenthesis is appended after the measurement function. This indicates numerical data related to all waveforms including the fundamental and the harmonics.



- **Measurement function of the motor module**

The following seven types of numerical data can be determined. For details related to the determination of measurement functions, see “Chapter 15” or “Appendix 2.”

Measurement Function	Chars and numbers inside ( )			All (No ( ))	
	dc	1	k		
Torque( )	Yes	Yes	Yes	Yes	Yes : Numerical data exist
Speed, Sync, Slip, Pm, Motor efficiency ( $\eta_{mA}$ or $\eta_{mB}$ ), Total efficiency ( $\eta_{mA}$ or $\eta_{mB}$ )	No	No	No	Yes	

- The meaning of measurement functions with parentheses varies depending on the characters or numbers that are inside the parentheses as follows:
  - dc: Indicates numerical data of the DC component.
  - 1: Indicates numerical data of the fundamental wave.
  - k: Indicates numerical data from 2nd to Nth order harmonics. N is the upper limit of the harmonic order under analysis (see section 17.5). The upper limit is determined automatically (maximum is 500) by the frequency of the PLL source.
  - All: No parentheses are appended after the measurement function. Indicates numerical data related to all waveforms including the fundamental and harmonics.

#### Element number

When an input module is installed in a slot that is located on the rear side of the main unit, the slot combined with the input module is referred to as an element. The main unit can contain up to four elements which are numbered from one to four. On power measurement modules, one voltage and current pair can be input to each element. The element number is appended to the symbols that were defined in the earlier section, “Harmonic measurement function on each power measurement module” so that the correspondence can be seen. For example, “U1(2)” represents the 2nd order harmonic voltage of element 1.

#### Wiring method

The wiring method is the method by which the signals that are input to each element are combined. Different selections are possible depending on the number of elements that have power measurement modules installed. In some cases, only one type of wiring method can be selected, while in other cases, two types of wiring methods can be selected. When two types of wiring methods are selected, “A” or “B” is appended to the symbols that were defined in the earlier section “Harmonic measurement function of the average or the sum of the power measurement modules ( $\Sigma$ function)” so that the correspondence can be seen.

For example, “U $\Sigma$ A(2)” represents the average value of the 2nd order harmonic voltage of power measurement modules that are combined using wiring method A.

#### PLL source «For procedures, see section 5.1.»

When measuring harmonics, the fundamental period (period of the fundamental signal) must be determined in order to analyze the higher orders. The PLL (phase locked loop) source is the signal that is used to determine the fundamental period. Specify a signal that has the same period as the signal being measured. Selecting a signal with little distortion or fluctuation for the PLL source will result in a stable harmonic measurement. An ideal signal would be a rectangular wave with an amplitude that is greater than or equal to 50% of the measurement range (see section 1.3).

**Measurement/Computation Period «For procedures, see section 10.1.»**

**During normal measurement mode**

There are three methods of selecting the period. The measurement/computation period is set using one of the methods and the numerical data are measured or calculated using only sampled data\*<sup>1</sup> within the period\*<sup>2</sup>.

\*1 For information on the sampled data, see section 1.3 “Acquiring Data (Voltage and Current Signals).”

\*2 However, when the method of selecting the period is set to zero crossing, the numerical data of the maximum values (Peak) of voltage and current are determined over the entire screen (display record length). Thus, other measurement functions such as U+pk, U-pk, I+pk, I-pk, CfU, Cfl, FfU, and Ffl that are determined from the maximum values of voltage and current are also measured or computed over the entire screen.

• **Zero crossing setting**

The measurement/computation period is set to the period between the first point on the screen where the reference input signal crosses the zero level (the center value of the amplitude) on a rising slope\* to the last point on the screen where the signal crosses the zero level on a rising slope. When there is only one or there is no rising slope on the screen, the measurement/computation period is set to the entire width of the screen. When using the zero crossing setting, you can specify which input signal to use to synchronize to the zero crossing point for each element. The synchronizing signal can be selected as CH1 through CH8 or as the external clock.

\* Slope refers to the movement of the signal such as the movement from a low level to a high level (rising) or the movement from a high level to a low level (falling).

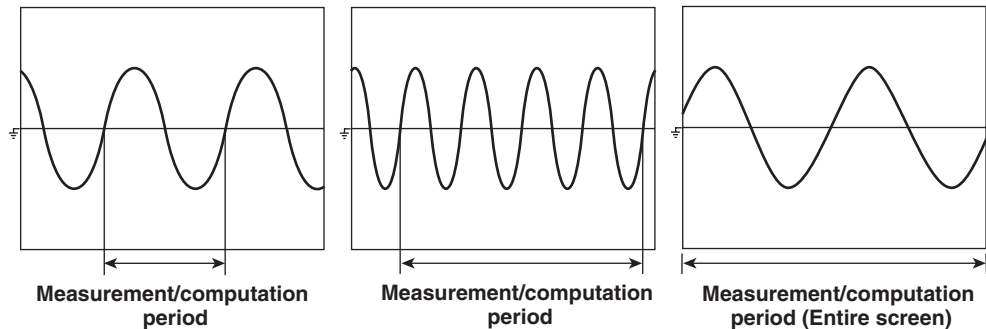

• **Cursor setting**

The measurement/computation period is set to the period between the two vertical cursors placed on the screen (t1 - t2). You can set the measurement/computation period while viewing the displayed waveform and moving the cursor.

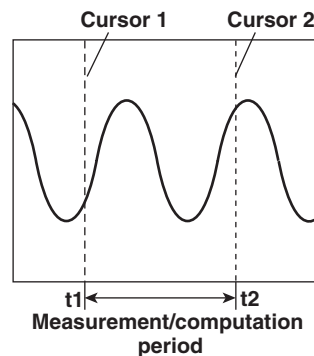

- **External trigger setting**

The measurement/computation period is set to the first period of time in which the signal applied to the external trigger input connector is in the specified Hi or Lo condition.

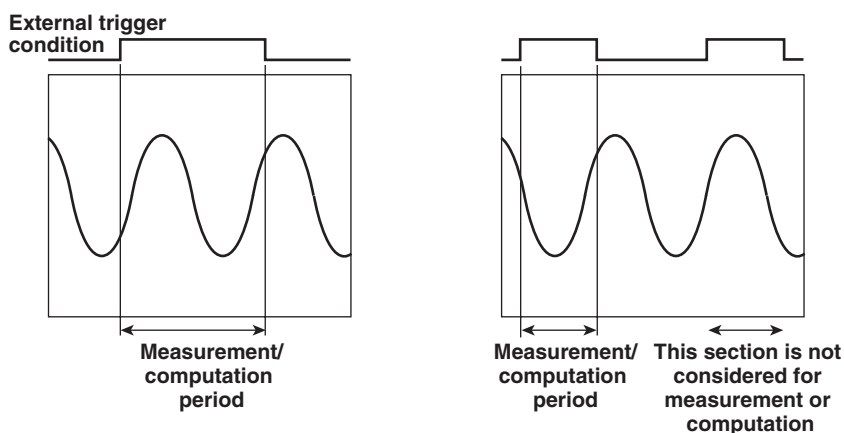

**During the harmonic measurement mode**

Cursor setting is the only method available to select the period. The numerical data are measured or computed from the sampled data in the specified period.

The period is 8192 sampled points between the vertical cursors placed on the screen. You can set the measurement/computation period while viewing the displayed waveform and moving the cursor.

**Wiring Method «For procedures, see section 5.2.»**

The wiring method is the method by which the signals that are input to each element are combined. Different selections are possible depending on the number of elements that have power measurement modules installed. In some cases, only one type of wiring method can be selected, while in other cases, two types of wiring methods can be selected. The following five wiring methods are available.

1P2W (single-phase two-wire), 1P3W (single-phase three-wire), 3P3W (three-phase three-wire), 3V3A (three-voltage, three-current), 3P4W (three-phase four-wire)

When determining the  $\Sigma$ functions such as voltage, current, active power, apparent power, reactive power, power factor, and phase difference, how the elements and numerical data are combined varies depending on the wiring method. For details pertaining to the relationship between the wiring method and  $\Sigma$ functions, see Appendix 2.

**Number of Displayed Digits «For procedures, see section 8.1.»**

The maximum number of displayed digits (highest display resolution) for the various items such as voltage, current, active power, apparent power, reactive power, and power factor can be set to five or six digits. However, the actual number of displayed digits may sometimes be smaller than the specified number depending on the combinations of the voltage and current ranges or the carry-over operation. For details, see chapter 16.

## 1.3 Acquiring Data (Voltage and Current Signals)

### Sampled Data

The instrument samples the voltage and current signals at a given sampling rate\* and stores the sampled data in the acquisition memory. The sampled data are processed and converted to the numerical data of measurement functions and into data used to display the waveform on the screen. In addition, the sampled data can be saved on a recording medium as waveform data. The saved waveform data can also be loaded from the recording medium and displayed on the screen or used to calculate specific numerical data.

- \* The sampling rate indicates the number of data points that are acquired into the acquisition memory in one second. For example, a sampling rate of 10 kS/s indicates that 10,000 points of data are acquired in one second. The sampling rate of the instrument is automatically determined depending on the observation time and the record length (explained later). For the relationship between the observation time, sampling rate, and record length, see Appendix 1.

### Input module

The input module is equipped with terminals for inputting voltage and current signals. It is installed into the slot located on the rear side of the main unit (model : 253710). For the different types, see "Input module" on page iv.

### Element and Channel

#### Element

When an input module is installed in a slot that is located on the rear side of the main unit, the slot combined with the input module is referred to as an element. The main unit can contain up to four elements which are numbered from one to four. On power measurement modules, one voltage and current pair can be input to each element.

#### Channel

The voltage and current input terminals of each element are assigned channel numbers as follows.

Element Number	Voltage	Current
1	CH 1	CH 2
2	CH 3	CH 4
3	CH 5	CH 6
4*	CH 7	CH 8

- \* When the motor module is installed, the output voltage from the sensors is assigned to CH7 and CH8. However, motor modules can be used on only products (PZ4000) with firmware version 2.01 or later.

## Measurement Range of Voltage, Current, and Power

«For procedures, see section 5.3.»

When directly inputting voltage or current signals to the input module, there are two types of measurement ranges : fixed range and auto range. When displaying the waveform, the measurement range corresponds to the vertical display range. For waveform display, see section 1.6 “Waveform Display.”

### Fixed range

Select the range from a list of choices. The selected range does not change even if the amplitude of the input signal changes. For the voltage of the power measurement module, the maximum and minimum selectable voltages are “2000 Vpk” and “30 Vpk,” respectively.

### Auto range

The measurement range changes automatically depending on the amplitude of the input signal. The different ranges are the same as those available for the fixed range. Note that when the measurement function of the power measurement module is set so that the numerical data are not measured or computed (when the Measure Mode is OFF), you can select auto range. However, the range does not change in this case.

### Power range

The measurement range (power range) of active power, apparent power, and reactive power of the power measurement module are determined by the wiring method, voltage range, and current range as follows. For the actual numerical values of the power range, see section 5.3 “Setting the Measurement Range during Direct Input.”

Wiring Method	Power Range
1P2W (single-phase two-wire)	voltage range × current range
1P3W (single-phase three-wire)	voltage range × current range × 2
3P3W (three-phase three-wire)	(when the voltage and current ranges on the corresponding elements are set to the same range)
3V3A (three-voltage, three-current)	
3P4W (three-phase four-wire)	voltage range × current range × 3
	(when the voltage and current ranges on the corresponding elements are set to the same range)

## Scaling «For procedures, see section 5.5.»

When inputting current signals to the power measurement module via an external current sensor or inputting voltage or current signals via the external PT (potential transformer) or CT (current transformer), the transformation ratio and coefficient can be specified.

### When inputting current signals via an external current sensor

The output of current sensors, such as shunts and clamps, can be input to the current sensor connector of the power measurement module and be measured. Set how many mV the current sensor outputs when 1 A of current flows (transformation ratio). Then, the input signal can be made to correspond to the numerical data or display data that are obtained when the current is directly applied to the input terminals.

Measurement Function	Transformation Ratio	Data before Conversion	Conversion Result
Current I	E	$I_s$ (current sensor output)	$I_s/E$
Active power P	E	$P_s$	$P_s/E$
Apparent power S	E	$S_s$	$S_s/E$
Reactive power Q	E	$Q_s$	$Q_s/E$
Max./Min. current value I <sub>pk</sub>	E	$I_{pk_s}$ (current sensor output)	$I_{pk_s}/E$

### 1.3 Acquiring Data (Voltage and Current Signals)

#### When inputting voltage or current signals via an external PT or CT

The output from the secondary side of the potential transformer can be connected to the same voltage input terminal used for direct input and the output of the secondary side of the current transformer can be connected to the same current input terminal used for direct input. Set the PT ratio, CT ratio, and power coefficient (coefficient multiplied by power determined from the voltage and current). Then, the input signal can be made to correspond to the numerical data or display data that are obtained when the current is directly applied to the input terminals.

Measurement Function	Transformation Ratio	Conversion Result	
Voltage U	$U_2$ (secondary output of PT)	$U_2 \times P$	P : PT ratio
Current I	$I_2$ (secondary output of CT)	$I_2 \times C$	C : CT ratio
Active power P	$P_2$	$P_2 \times P \times C \times SF$	SF : power coefficient
Apparent power S	$S_2$	$S_2 \times P \times C \times SF$	
Reactive power Q	$Q_2$	$Q_2 \times P \times C \times SF$	
Max./Min. current value Ipk	$I_{pk2}$ (secondary output of C)	$I_{pk2} \times C$	

#### Input Filter (Line Filter and Zero Crossing Filter) «For procedures, see section 5.6.»

There are two types of filters. This instrument makes measurements by synchronizing to the input signal. Therefore, the frequency of the input signal must be measured accurately. These filters are used for this purpose.

##### Line filter

This filter is inserted into the measurement circuit. It removes the noise from the inverter and from distorted waveforms. The cutoff frequency can be selected.

##### Zero crossing filter

This filter is inserted only into the frequency measurement circuit. Zero crossing refers to the point at which the input signal crosses the center level of the amplitude. This filter is used to accurately detect the zero cross point. The cut-off frequency can be selected. This instrument can detect the zero crossing point with a hysteresis of approximately 3.5% of the measurement range. The zero crossing detection is used to determine the measurement/computation period, measure frequency, determine the period of a PLL source, and is used as a trigger condition for the HF auto mode and HF normal mode (explained later).

**Observation Time** «For procedures, see section 6.1.»

The observation time represents the time span of one screen.

**During normal measurement mode**

The selectable range is from 10  $\mu$ s to 1 ks\*. The sampling rate changes depending on the observation time. The sampling rate is used to acquire the data to the acquisition memory.

For information on the waveform display, see section 1.6 "Waveform Display."

\* 1 ks denotes 1000 s (16 minutes 40 seconds).

**During the harmonic measurement mode**

The observation time for the harmonic measurement mode is automatically determined from the sampling rate that is determined from the fundamental frequency of the PLL source (see page 1-9) and the record length (see next section). For the relationship between observation time, sampling rate, and record length, see Appendix 1.

For the harmonic measurement mode, the sampling rate depends on an external signal referred to as the PLL source (signal under measurement or external clock signal) and therefore, the observation time cannot be set uniformly as in the normal measurement mode. In the harmonic measurement mode, the time it takes to store the record length of sampled data in the acquisition memory is the time displayed on one screen.

**Record length** «For procedures, see section 6.2.»**During the normal measurement mode**

On this instrument, the record length refers to the data capacity of the acquisition memory per channel. It can be selected as 100 k-, 1 M- (option), or 4 M-(option) words.

The sampled data in the acquisition memory are P-P compressed (see page 1-27) and displayed. The number of data points displayed on the screen is referred to as the display record length. The size of the display record length varies depending on the observation time setting and the maximum size is equal to the record length.

When the observation time is long, the record length and display record length are the same, but when the observation time is short, the display record length becomes shorter than the record length.

**During the harmonic measurement mode**

The record length can be selected as 100 k-, 1 M- (option), or 4 M-(option) words. For the harmonic measurement mode, the display record length and record length are always equal.

**Dividing the record length** «For procedures, see section 6.2.»

The acquisition memory can be divided in half so that it appears as though there are two memories. The data can be acquired to each memory separately.

When there is only one acquisition memory (the acquisition memory is not divided) and the data acquisition is aborted, the sampled data are discarded. The numerical data are not measured, computed, or displayed and the waveform is also not displayed. If the operation is stopped normally, the acquisition stops after acquiring the display record length of sampled data. In this case, the numerical data can be measured, computed, and displayed and the waveform can also be displayed.

If the acquisition memory is divided into two memories and the data are acquired alternately to those two memories, then even when the data acquisition to one memory is aborted, the previously sampled data remain in the other memory. Therefore, the numerical data can be measured, computed, and displayed and the waveform can be displayed based on those data. The operation is the same when the acquisition is stopped normally. The acquisition is aborted, and the numerical data and waveform are displayed based on the previous sampled data. This function of dividing the record length can be used when you wish to analyze a waveform while viewing a waveform that is being continuously acquired.

- **When the memory is not divided**

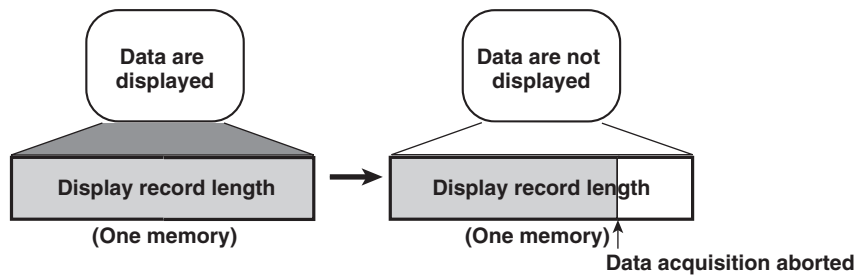

- **When the memory is divided**

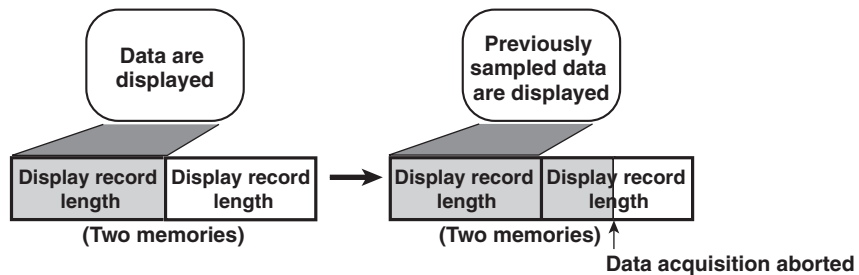

**Time Base** «For procedures, see section 6.3.»

With the default setting of the instrument, the data sampling timing is controlled by the clock signal that is generated by the internal time base circuit. This setting can be changed so that the timing is controlled by an external clock signal. This feature is useful when measuring signals that have changing periods or when measuring a signal by synchronizing to the clock signal of the device being measured.

In addition, for harmonic measurements, accurate measurements can be made by synchronizing to an external clock signal that has a period that is an integer multiple of the fundamental frequency (frequency of the fundamental signal).



**Zero Level Compensation** «For procedures, see section 4.4.»

Zero level compensation refers to the operation of adjusting the level to zero using an internal circuit of the instrument. Zero level compensation must be performed in order to meet the specifications of the instrument (see chapter 17). When the measurement mode, measurement range, and input filter are changed, zero level compensation is performed automatically. However, if these parameters are not changed over a long period of time, the zero level may change due to changes in the environment surrounding the instrument. In such cases, the zero level can be forcibly compensated.

**NULL Function** «For procedures, see section 4.5.»

The Udc and Idc (numerical data of the simple average of the voltage and current in the normal measurement mode) as well as Speed and Torque (when using the motor module and the input signal from the sensor is a DC voltage) that have been measured when the NULL function is turned ON are set as NULL values. The null values are subtracted from the voltage and current data. Therefore, all measurement functions are influenced by the NULL value. When setting the NULL value, we recommend that the voltage and current measurement ranges be set as small as possible. The measurement resolution is higher when the measurement range is small which results in a more accurate measurement of the NULL value.

## 1.4 Trigger

The trigger is used to display the sampled data stored in the acquisition memory as waveforms on the screen. The trigger is activated when the specified trigger condition is met.

### Trigger Source «For procedures, see section 7.2.»

Trigger source refers to the signal that is used in checking the trigger condition.

### Trigger Slope «For procedures, see section 7.3.»

Slope refers to the movement of the signal such as the movement from a low level to a high level (rising) or the movement from a high level to a low level (falling). When the slope is used as one of the trigger conditions, it is called a trigger slope.

### Trigger Level «For procedures, see section 7.3.»

Trigger level refers to the level that is used to judge the passing level of the trigger slope or the condition of the trigger source.

### Trigger Type «For procedures, see section 7.3, 7.4.»

There are two types of triggers, edge trigger and window trigger.

#### Edge trigger

A trigger occurs when the trigger source rises above or falls below a preset trigger level. The trigger source can be selected as the input signals of CH1 through CH8 or as the external trigger input signal.

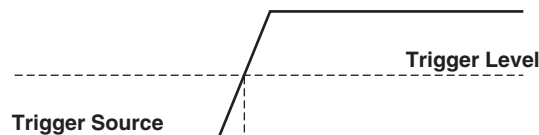

A trigger occurs at this point if rising edge ( $\uparrow$ ) is selected.

#### Window trigger

A certain window width is set and a trigger occurs when the trigger source level enters this window (IN) or exits from this window (OUT).

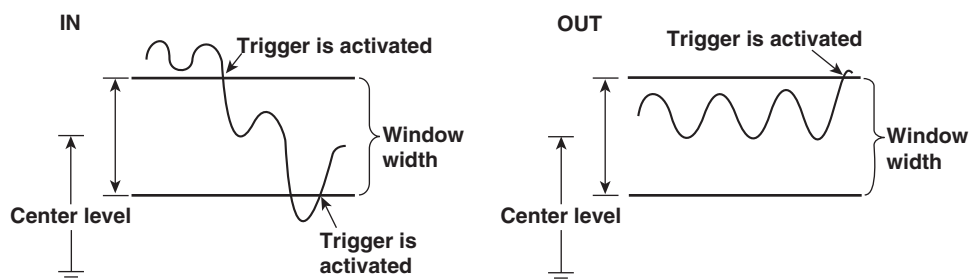

## Trigger Mode «For procedures, see section 7.1.»

The trigger mode is used to set the conditions for updating the display. There are two main modes, OFF mode and ON mode.

### OFF mode

In this mode, the display record length of data is acquired to the memory from the point at which the acquisition is started regardless of the trigger conditions. The resultant data are displayed. This mode has the advantage of not requiring one to set trigger conditions. However, a stable waveform display cannot be maintained.

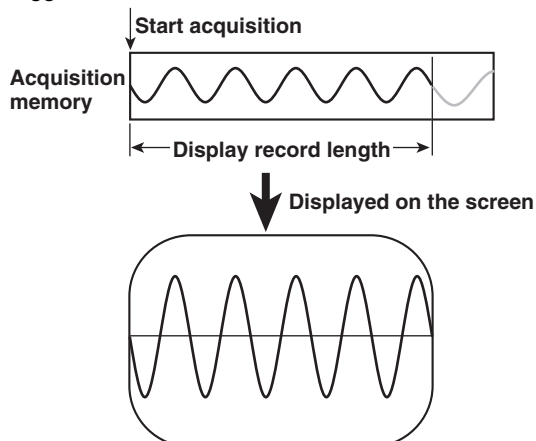

### ON mode

There are five types of ON modes. When the condition for the specific mode is satisfied, the trigger occurs and the waveform display is updated.

As an example, we will consider the case when the trigger position (described in the next section) and the trigger point are matched, and the trigger position is located on the left end of the screen.

In this case, when a trigger occurs after the data acquisition is started, an amount of data equal to the display record length is displayed starting from the trigger point.

### Note

The following figure indicates the schematic of acquiring sampled data when a trigger occurs and displaying the waveform on the screen.

When the display record length is longer than the remaining record length after the trigger point

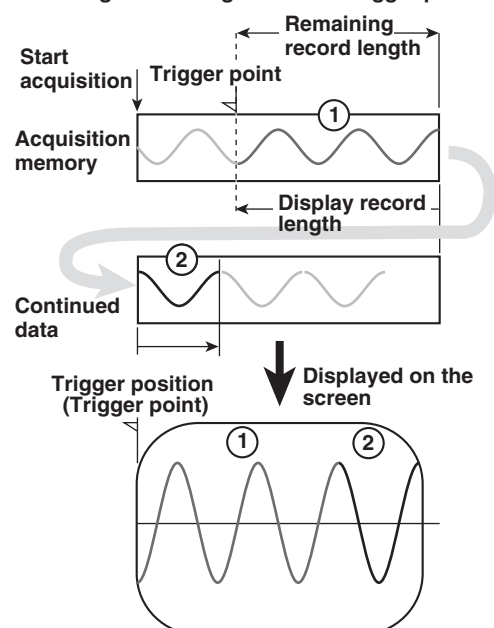

When the display record length is shorter than the remaining record length after the trigger point

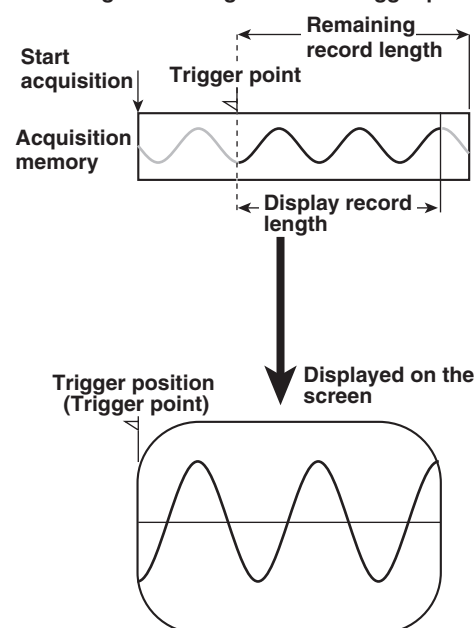

## 1.4 Trigger

---

- **Auto mode**

If a trigger occurs within a specified amount of time (about 100 ms, referred to as the timeout period), the waveform display is updated. If the trigger does not occur within the timeout period, the waveform display is automatically updated.

- **Auto-level mode**

If a trigger occurs within the timeout period, the waveform is displayed in the same way as in the auto mode. If a trigger does not occur within the timeout period, the center value of the amplitude of the trigger source is detected, the trigger level is automatically changed to the center value, and the trigger is generated to update the displayed waveform.

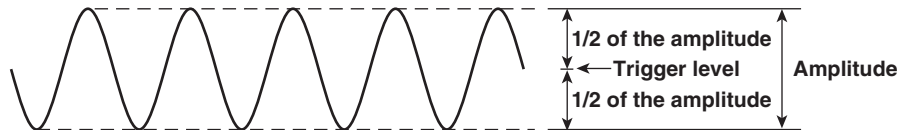

- **Normal mode**

The waveform display is updated only when the trigger occurs. If a trigger does not occur, the display is not updated.

- **HF auto mode**

The output of the zero crossing detector of the trigger source is used to detect the trigger condition. When the zero crossing filter is set, the trigger becomes less susceptible to harmonic noise and unexpected triggers are prevented from occurring. Because the trigger occurs when the input signal crosses the center level of the amplitude of the trigger source (a hysteresis of approx. 3.5% of the measurement range exists) and the display is updated, the trigger level setting is void.

- **HF normal mode**

The method in which the trigger is activated is the same as in the HF auto mode. The behavior with respect to the timeout period is the same as in the normal mode.

**Trigger Position** «For procedures, see section 7.5.»

The trigger position is used to set which section of the sampled data in the acquisition memory to display on the screen. When the trigger delay (described in the next section) is set to 0 s, the trigger point and trigger position match. In this case, if you wish to display the sampled data before the trigger point, you would move the trigger position from the left end of the screen to the right and then perform data acquisition. For example, if the trigger position is moved to the horizontal center of the screen (50%), then the area to the left of the trigger position will be displaying data that existed before the trigger point. The section before the trigger position is called the pre-trigger section and the section after the trigger position is called the post-trigger section. If the observation time (described earlier) is changed, the display range changes around the trigger position.

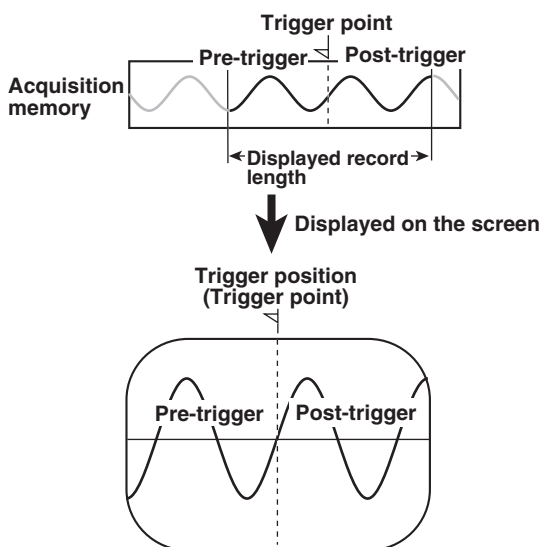

**Trigger Delay** «For procedures, see section 7.6.»

The trigger position matches the trigger point when the trigger delay is set to 0 s. This function allows you to display the waveform that is acquired the specified amount of time after the trigger point (delay time).

When the trigger delay is set to 0 s

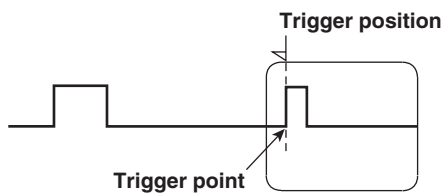

When a trigger delay is set

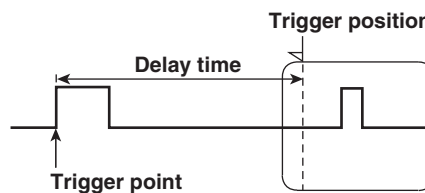

# 1.5 Numerical Display

The numerical data can be displayed. The display format varies depending on whether the measurement mode is set to normal measurement or harmonic measurement. In addition, the screen can be divided into top and bottom halves so that the numerical data and waveform can be displayed at the same time. (Waveform display is explained later.)

## Numerical display during the normal measurement mode

«For procedures, see section 8.2, 8.3.»

### Selecting the number of displayed items

You can select the number of displayed items in the range from eight to all. When the numerical data and waveform are displayed at the same time, only half of the selected number of items is displayed. All items cannot fit on one screen. Thus, a scroll function is provided so that all data can be viewed.

- Example in which eight items are displayed

	Urms1	5.1290 V	
Measurement function	Umn1	4.5265 V	Data
	Udc1	1.1130 V	
	Uac1	5.0068 V	
	Irms1	4.9235 A	
	Imn1	4.9231 A	
	Idc1	-0.0434 A	
	Iac1	4.9233 A	

- Example in which all items are displayed

		Element and wiring method					
		Element1	Element2	Element3	Element4	Σ A	Σ B
Measurement function	UrmsV	5.1290	5.1124	5.1293	5.1460	5.1290	5.1124
	UmnV	4.5265	4.5112	4.5263	4.5540	4.5265	4.5112
	UdcV	1.1130	1.1057	1.1140	1.1091	1.1130	1.1057
	UacV	5.0068	4.9914	5.0069	5.0088	5.0068	4.9914
	IrmsA	4.9235	4.9043	4.9430	49.369	4.9235	4.9043
	ImnA	4.9231	4.9039	4.9427	49.363	4.9231	4.9039
	IdcA	-0.0434	-0.0394	-0.0446	-0.527	-0.0434	-0.0394
	IacA	4.9233	4.9041	4.9428	49.366	4.9233	4.9041
	PW	-0.056	-0.048	-0.058	-0.00039k	-0.056	-0.048
	S	25.253	25.073	25.354	0.25405k	25.253	25.073
	Q	25.253	25.073	25.354	0.25405k	-25.253	-25.073
	λ	-0.00220	-0.00193	-0.00227	-0.00155	-0.00220	-0.00193
	φ	-90.126	-90.111	-90.130	90.009	-90.126	-90.111
	fU	50.00	50.00	50.00	50.01	-----	-----
	fI	1.000k	1.000k	1.000k	1.000k	-----	-----
	U-pkV	9.0400	9.7992	9.8399	9.9583	-----	-----
	U-pkV	-7.7564	-7.7209	-7.7748	-7.6748	-----	-----
	I-pkA	7.0628	7.0622	7.1137	70.618	-----	-----
	I-pkA	-7.1689	-7.1589	-7.2174	-71.533	-----	-----
	CfU	1.919	1.917	1.918	1.935	-----	-----
	CfI	1.456	1.460	1.460	1.449	-----	-----
	FFU	1.259	1.259	1.259	1.255	-----	-----
	FFI	1.111	1.111	1.111	1.111	-----	-----
	Z	1.04173	1.04244	1.03770	104.235m	1.04173	1.04244
	Rs	1-2.2968Sn	-2.01449n	-2.35409n	-0.000	-2.2968Sn	-2.01449n

**Changing the displayed items**

By selecting the display item, the numerical data value that is displayed at the position can be changed.

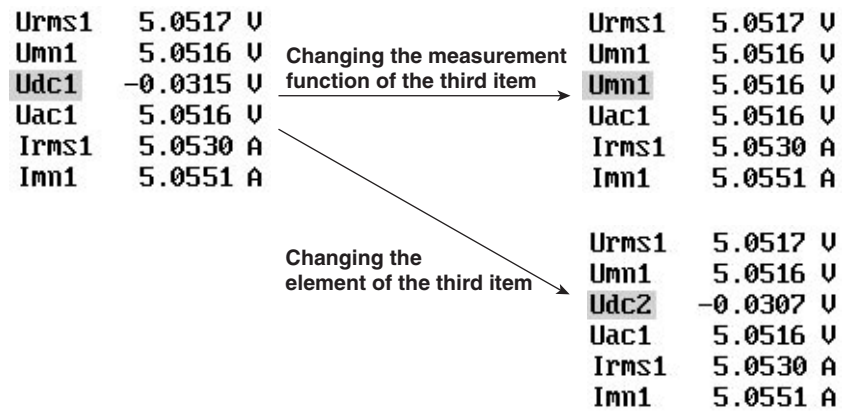

**Numerical display during the harmonic measurement mode**

«For procedures, see section 8.4, 8.5.»

**Selecting the number of displayed items**

You can select either eight or 16 for the number of displayed items. When the numerical data and waveform are displayed at the same time, only half of the selected number of items are displayed. All items cannot fit on one screen. Thus, a scroll function is provided so that all data can be viewed.

• **Example in which eight items are displayed**

	U1	5.0545 V	
Measurement function ↓	I1	4.7348 A	Data ↓
	P1	0.067 W	
	S1	0.082 VA	
	Q1	0.047 var	
	U1(1)	4.0427 V	
	I1(1)	0.0172 A	
	P1(1)	0.069 W	

• **Example in which 16 items are displayed**

Measurement function ↓	u1	5.0545 V	s1(1)	0.070 VA	Data ↓
	i1	4.7348 A	q1(1)	0.007 var	
	p1	0.067 W	λ1(1)	0.99552	
	s1	0.082 VA	φ1(1)	5.423 °	
	q1	0.047 var	φu1(2)	-0.134 °	
	u1(1)	4.0427 V	φi1(2)	99.075 °	
	i1(1)	0.0172 A	fui(1)	-0.000mHz	
	p1(1)	0.069 W	fii(1)	0.000mHz	

**Changing the displayed items**

By selecting the display item, the numerical data value that is displayed at the position can be changed.

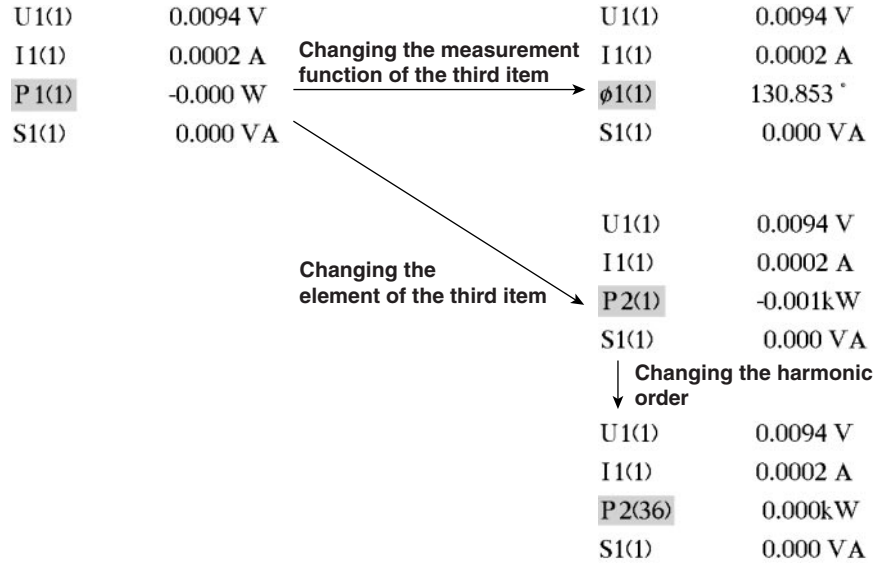

**List display**

For each measurement function, the numerical data of the fundamental and all harmonics can be displayed in two columns. When the numerical data and waveform are displayed at the same time, approximately half of the data is displayed.

• **Single list**

The data of one measurement function are displayed by separating the even and odd harmonics in each column. You can select the following measurement functions: U, I, P, S, Q, λ, φ, φU, φI, Z, Rs, Xs, Rp, Xp, and Torque\*.

\* This is applicable to products (PZ4000) with firmware version 2.01 or later when the motor module is installed in the element number 4 slot.

Data related to the all harmonic signals

PLL	CH1(U1)	5.0545	dc	1.0429	20.633
Freq	46 Hz	1 4.0427	79.902	2 3.0339	60.023
U1	5.0545 U	3 0.0144	0.285	4 0.0060	0.135
I1	4.7348 A	5 0.0059	0.117	6 0.0048	0.096
P1	0.067 W	7 0.0037	0.072	8 0.0041	0.080
S1	0.	9 0.0021	0.041	10 0.0021	0.043
Q1	0.	11 0.0022	0.044	12 0.0022	0.043
λ1	0.81	13 0.0022	0.043	14 0.0016	0.032
φ1	-35.	15 0.0018	0.035	16 0.0014	0.029
Uthd	75.	17 0.0009	0.018	18 0.0013	0.026
Ithd	7524.	19 0.0015	0.030	20 0.0012	0.023
Pthd	3.	21 0.0007	0.013	22 0.0012	0.023
Uthf	Er	23 0.0012	0.023	24 0.0007	0.014
Ithf	Er	25 0.0004	0.008	26 0.0011	0.022
Uthf	Er	27 0.0008	0.016	28 0.0014	0.028
Uthf	1.	29 0.0008	0.016	30 0.0007	0.014
Ithf	4999.	31 0.0009	0.018	32 0.0010	0.021
hOf	0.	33 0.0008	0.016	34 0.0006	0.011
hcf	0.	35 0.0010	0.019	36 0.0010	0.020
		37 0.0010	0.020	38 0.0007	0.014
U2	5.0383 U	39 0.0005	0.010	40 0.0007	0.014
I2	0.0011 A	41 0.0002	0.004	42 0.0004	0.007
P2	-0.000 W	43 0.0005	0.011	44 0.0005	0.010
S2	0.000 VA	45 0.0004	0.009	46 0.0007	0.014

Harmonic order

Numerical data of each harmonic

Harmonic distortion factor  
(When the selected measurement function is U, I, or P, Uthd, Ithd, or Phd is displayed, respectively.)



• **Dual list**

The data of two measurement functions are displayed in its own column. You can select the following measurement functions: U, I, P, S, Q,  $\lambda$ ,  $\phi$ ,  $\phi U$ ,  $\phi I$ , Z, Rs, Xs, Rp, Xp, and Torque\*.

\* This is applicable to products (PZ4000) with firmware version 2.01 or later when the motor module is installed in the element number 4 slot.

Data related to the all harmonic signals

PLL	CH1 (U1)	5.0545	-----	4.7348	-----
Freq	49 Hz	dc	1.0423	20.633	dc -0.0530 -1.120
		1	4.0427	79.982	1 0.0172 0.363
U1	5.0545 U	2	3.0339	60.023	2 0.0187 0.396
I1	4.7348 A	3	0.0144	0.285	3 0.0182 0.384
P1	0.067 W	4	0.0068	0.135	4 0.0180 0.381
S1	0.0	5	0.0059	0.117	5 0.0191 0.404
Q1	0.0	6	0.0048	0.096	6 0.0201 0.425
$\lambda 1$	0.81f	7	0.0037	0.072	7 0.0192 0.405
$\phi 1$	-35.2	8	0.0041	0.080	8 0.0223 0.472
Uthd	75.0	9	0.0021	0.041	9 0.0231 0.489
Ithd	7524.0	10	0.0021	0.043	10 0.0226 0.477
Phd	3.0	11	0.0022	0.044	11 0.0282 0.596
Uthf	Err	12	0.0022	0.043	12 0.0289 0.611
Ithf	Err	13	0.0022	0.043	13 0.0294 0.621
Uthf	1.5	14	0.0016	0.032	14 0.0399 0.844
Ithf	4999.0	15	0.0018	0.035	15 0.0432 0.913
hdf	0.0	16	0.0014	0.029	16 0.0470 0.932
hcf	0.0	17	0.0009	0.018	17 0.0750 1.585
		18	0.0013	0.026	18 0.1027 2.168
U2	5.0383 U	19	0.0015	0.030	19 0.1741 3.678
I2	0.0011 A	20	0.0012	0.023	20 4.7228 99.746
P2	-0.000 W	21	0.0007	0.013	21 0.1928 4.072
S2	0.000 W	22	0.0012	0.023	22 0.0753 1.594

Numerical data of each harmonic

Harmonic distortion factor (When the selected measurement function is U, I, or P, Uthd, Ithd, or Phdf is displayed, respectively.)

•  **$\Sigma$  List**

Displays the measurement function data (such as U, I, P, S, Q,  $\lambda$ , and  $\phi$ ) of each element and wiring methods A and B for the selected harmonic orders.

Measurement function

		Element and wiring method				$\Sigma$ A	$\Sigma$ B
		Element1	Element2	Element3	Element4		
U	IU	1 4.0523	4.0364	4.0490	4.0520	4.0523	4.0364
I	IA	1 0.00074	0.005m	0.004m	0.0042	0.00074	0.005m
P	IU	1 -0.001	0.00002	0.00002	-0.00002k	-0.001	0.00002
S	IUA	1 0.003	0.00002	0.00002	0.00002k	0.003	0.00002
Q	Ivar	1 -0.003	0.00000	0.00000	-0.00001k	-0.003	0.00000
$\lambda$	I	1-0.33571	0.99096	0.99904	-0.90405	-0.33571	0.99096
$\phi$	I <sup>c</sup>	1-109.616	2.620	2.509	-154.003		

**Page scroll of the list**

The data of all harmonics cannot fit on one screen. Thus, a scroll function is provided so that all data can be viewed.

**Resetting the Numerical Display «For procedures, see section 8.2, 8.4.»**

When displaying numerical data in the normal measurement or harmonic measurement mode, the order in which the measurement functions are displayed can be reset to a default. One default set is provided for each measurement mode.

# 1.6 Waveform Display

## Vertical (Amplitude) Axis and Horizontal (Time) Axis

### Vertical (amplitude) axis

The vertical display range is set to the specified measurement range. For example, if the voltage measurement range is set to “300 Vpk,” then the display range is set so that the top of the screen is 300 Vpk and the bottom is -300 Vpk with the zero input line at the center.

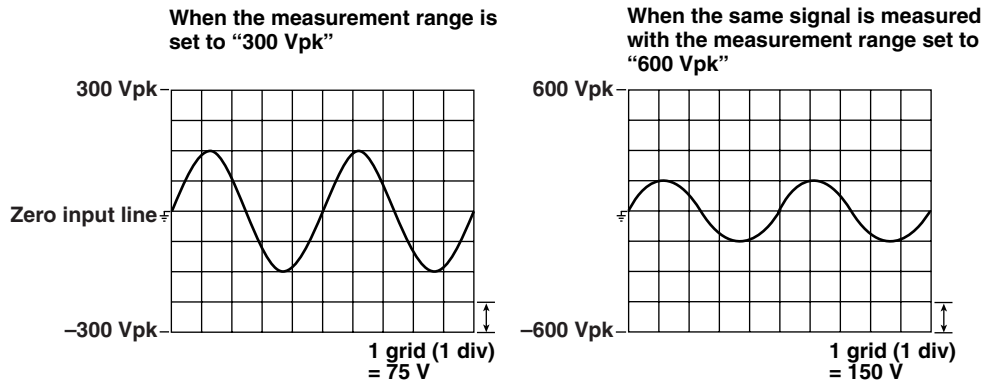

### Note

#### Display resolution of the vertical axis

Setting a measurement range that is close the maximum amplitude of the signal results in a more accurate waveform display. The instrument uses a 12-bit A/D converter, which results in the quantization of the sampled data using 4096 discrete levels. However, the waveform is displayed using 512 levels per grid. On the other hand, when using cursors (explained later) to measure the data from the waveform, the data are converted to a resolution of up to 16 bits.

### Horizontal (time) axis

The instrument displays the sampled data of the voltage or current within the observation time. The horizontal axis corresponds to the time axis of the observation time. The sampled data on the screen become more recent as you move from the left to the right on the horizontal axis. The grid on the screen divides the observation time into 10 equal sections. For example, if the observation time is set to 100 ms, then one grid (1 div) corresponds to 10 ms.

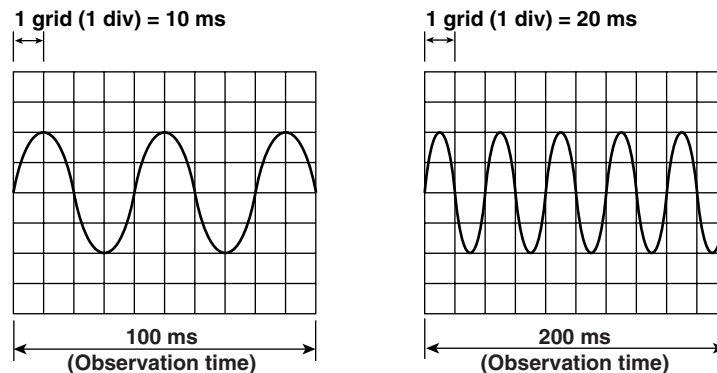

**Note****Number of displayed points on the screen**

When displaying the sampled data as a waveform on the screen, the data points are displayed in segments called rasters. There are 501 rasters in the time axis direction on one screen.

Recall that the sampled data are stored into the acquisition memory according to the sampling rate. Then, the display record length of the data is shown on the screen. The display record length varies depending on the record length and observation time. For the relationship between the observation time, sampling rate, and record length, see Appendix 1 "Relationship between the Observation Time, Sampling Rate, and Record length."

Because the number of display segments (number of displayed points) on the screen is constant while the display record length changes, there are times when the number of displayed points and the display record length do not match. In these cases, the following two scenarios occur.

- **When the display record length is larger than the number of displayed points**  
For each time segment, the instrument performs P-P compression. P-P compression refers to the determination of the maximum and minimum values for each segment. One raster will display these two points.
- **When the display record length is less than the number of displayed points**  
The instrument interpolates the display. For details, see "Display Interpolation of the Waveform."

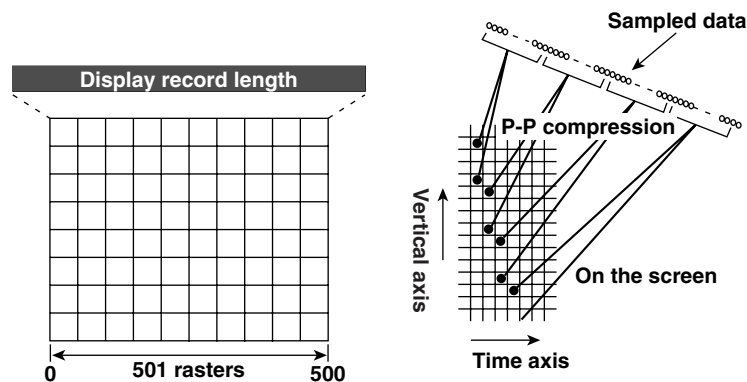
**Acquiring the sampled data**

The sampling rate changes when the measurement period is changed. The data can be sampled at a maximum rate of 5 MS/s. The input signal is sequentially sampled and stored in the acquisition memory.

**Aliasing**

When the sampling rate is comparatively low with respect to the input signal frequency, the measurement may be in error. In this case, some of the harmonics will appear at low frequencies due to the effects described by the Nyquist sampling theorem. This phenomenon is called aliasing.

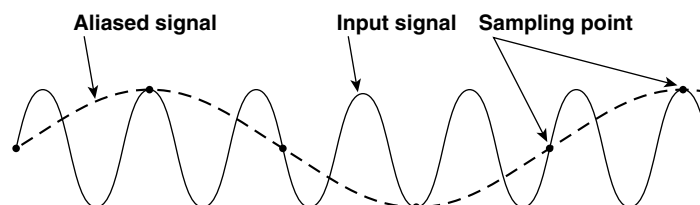

**Turning ON/OFF the Waveform Display «For procedures, see section 9.1.»**

The waveform of each channel corresponding to the element that has an input module installed, can be turned ON/OFF. The computation waveform (described in section 1.8 “Waveform Analysis”) can also be turned ON/OFF. This feature can make the viewing of important waveforms much easier due to the absence of clutter from unimportant waveforms.

**Vertical Position of the Waveform «For procedures, see section 9.2.»**

The displayed position of the waveform (vertical position) can be moved vertically to the desired position such as when the section of the waveform you wish to view goes out of the display frame due to vertical zoom.

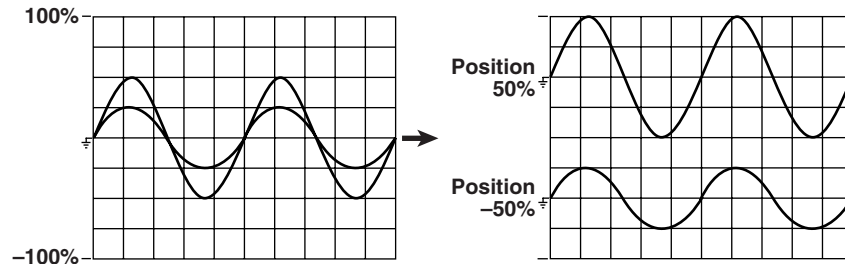

**Split Screen of the Waveform «For procedures, see section 9.3.»**

The screen can be equally divided and the waveform of each channel can be assigned to each divided window. The screen can be divided into up to four windows. This function is useful when there are many waveforms on the screen. You can select the method of assignment from the following list of choices:

- Auto  
The channels that are turned ON are assigned in order according to the channel number to the divided windows.
- Fixed  
The channels are assigned in order according to the channel number to the divided windows regardless of whether or not the display is turned ON.
- User\*  
The channels can be assigned arbitrarily to the divided windows regardless of whether or not the display is turned ON.

\* This is applicable to products (PZ4000) with firmware version 2.01 or later.

**Display Interpolation of the Waveform «For procedures, see section 9.4.»**

When there are less than 500 points of sampled data on the time axis, the waveform is no longer continuous. This function interpolates between the points so that the waveform appears to be connected.

**Linear interpolation**

Interpolates between two points using a line.

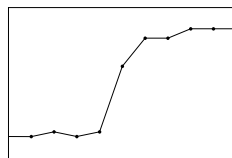

**Interpolation OFF**

No interpolation is performed. Only the data points are displayed.

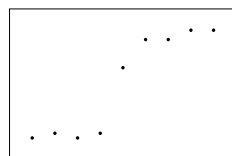

## Zooming on the Waveform «For procedures, see section 9.8.»

### Zooming vertically

The waveform of each channel can be expanded or reduced by the zoom factor which can range from 0.1 to 100. The waveform is zoomed around the zero input line.

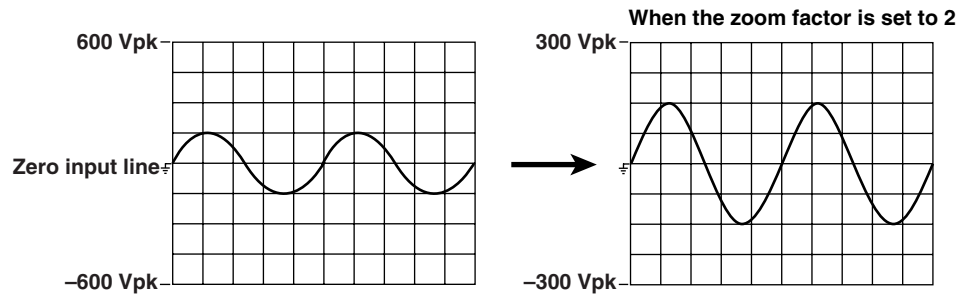

### Zooming horizontally

The selected waveforms can be expanded horizontally using two types of zoom factors. This function is useful when the observation time is long and you wish to observe a section of the waveform in detail.

- **Zoom factor**

When the display record length is larger than the number of displayable points, the instrument performs P-P compression for each time segment. This function can be used to lower the P-P compression rate so that each sampled data point in the acquisition memory can be observed. The maximum zoom factor that can be selected depends on the display record length and observation time. For example, the maximum zoom factor is 10,000 times when the observation time is 20 s and the display record length is 100 k-words. It is 100,000 times when the observation time is 20 s and the display record length is 1 M-word or 4 M-words.

When the display record length is less than the number of displayed points or when there are less than 500 points of sampled data on the time axis, such as when using a high zoom factor, the display points can be interpolated as explained in an earlier section.

- **Types of zoom displays**

The normal waveform that is not zoomed (Main waveform) and the zoomed waveform (Z1 and Z2 waveforms) can be displayed in different combinations as follows.

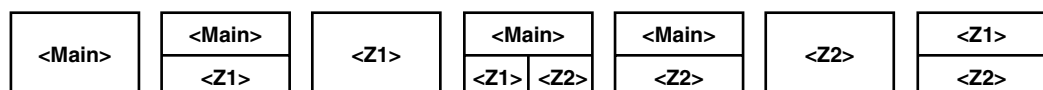

## 1.6 Waveform Display

- **Zoom position and zoom box**

The zoom position can be set in units of time. When the main waveform and Z1 or Z2 waveform are displayed at the same time, a zoom box indicating the zoom position is displayed in the main waveform screen. The center of the zoom box indicates the center of the zoomed waveform.

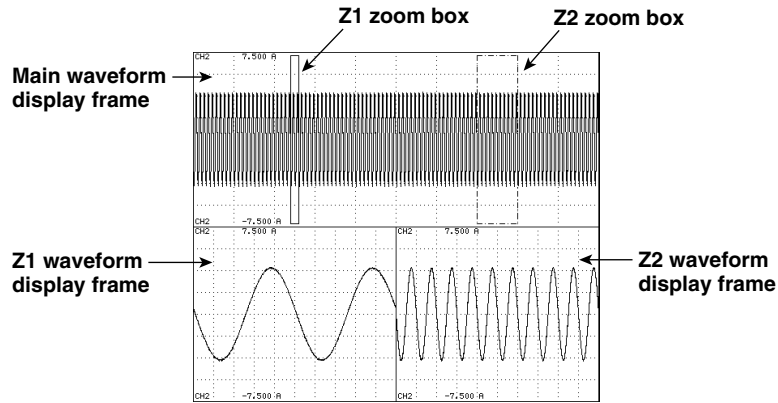

- **Split screen of the zoomed waveform**

As described in the earlier section “Split Screen of the Waveform,” the screen can be evenly divided and the waveform of each channel can be automatically assigned to the divided windows.

**Vector Display of Harmonics «For procedures, see section 9.9.»**

During the harmonic measurement mode, the phase difference and the amplitude (rms) relationships between the fundamental signal U(1) and the I(1) of the element that is wired using wiring method A can be displayed as vectors. The vector of each input signal is displayed with the positive vertical axis representing zero degrees. In addition, you can zoom in on the vector or display the values of the amplitude and the phase difference between the signals simultaneously.

\* This is applicable to products (PZ4000) with firmware version 2.01 or later.

**Vector display when the wiring method is 3P4W (three-phase four-wire)**  
 U1(1), U2(1), and U3(1) are common mode voltages. I1(1), I2(1), and I3(1) are line currents.

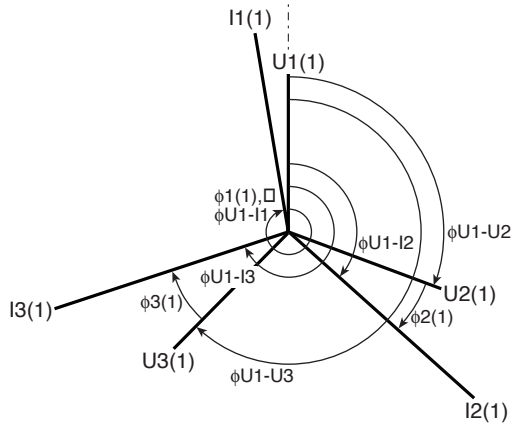

**Vector display when the wiring method is 3V3A (three-voltage, three-current)**  
 U1(1), U2(1), and U3(1) are line voltages. I1(1), I2(1), and I3(1) are line currents.

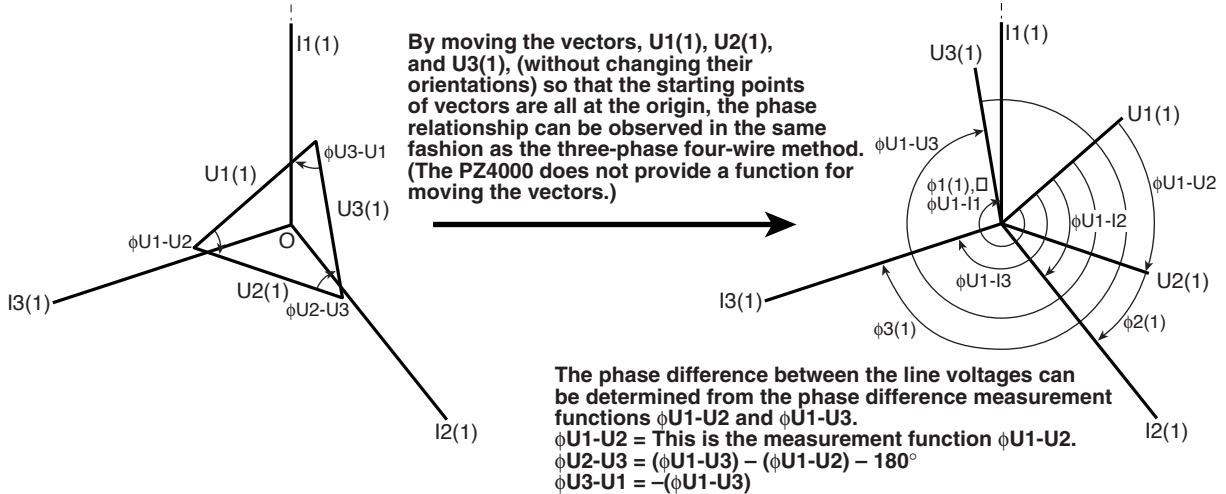

**Vector display when the wiring method is 3P3W (three-phase three-wire)**  
 U1(1), U2(1), and U3(1) are line voltages. I1(1), I2(1), and I3(1) are line currents. However, U3(1) and I3(1) are not actually measured for the three-phase three-wire method. The vectors are displayed through computation.

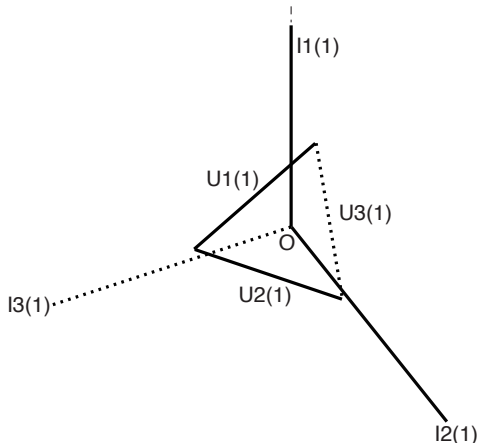

**Bar Graph Display of the Harmonic Data «For procedures, see section 9.10.»**

With the harmonic order assigned to the horizontal axis and the amplitude of the harmonics assigned to the vertical axis, the amplitudes of the harmonics can be displayed using a bar graph. The measurement function, element, and harmonic order can be specified. You can select U, I, P, S, Q,  $\lambda$ ,  $\phi U$ ,  $\phi I$ , Z, Rs, Xs, Rp, Xp, and Torque\* for the harmonic measurement function. The screen can be divided in half vertically, so that the bar graph and numerical data can be displayed at the same time.

\* This is applicable to products (PZ4000) with firmware version 2.01 or later when the motor module is installed in the element number 4 slot.

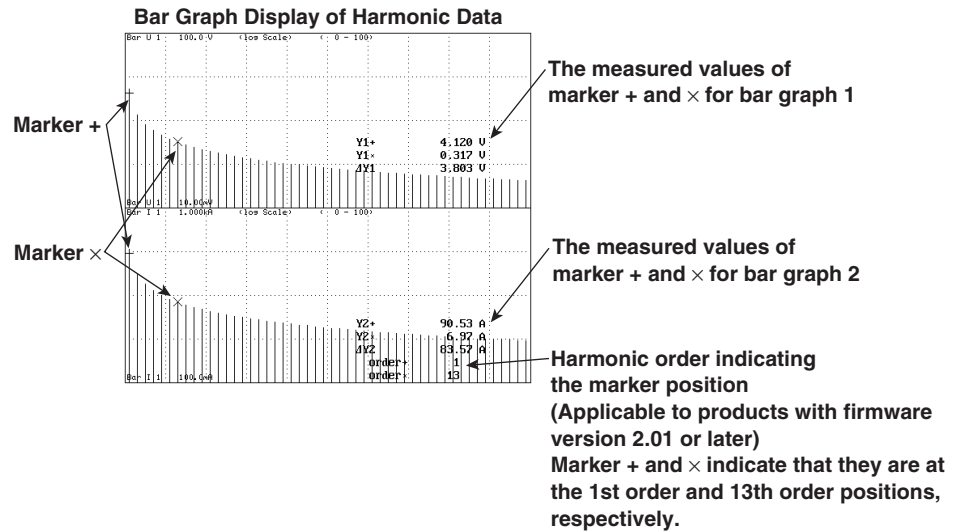

**X-Y Waveform Display «For procedures, see section 9.11.»**

The relationship between the amplitude levels between signals can be observed by assigning the amplitude of the input signal of the specified channel on the horizontal axis (X-axis) and the amplitude level of another input signal (signal that has the display turned ON) on the vertical axis (Y-axis). Simultaneous observation of X-Y waveform and normal T-Y waveform (waveform display using time axis and amplitude level) is also possible.



## Other Display Settings «For procedures, see section 9.5 to 9.7.»

### Graticule

A grid or cross scale can be displayed on the screen. You can also select not to display the grid or cross scale.

### Displaying the scale value

The upper and lower limits of the vertical axis and the values at the left and right ends of the horizontal axis (time axis) of each channel can be turned ON or OFF.

### Displaying the Waveform Labels

The waveform labels of each channel can be turned ON or OFF.

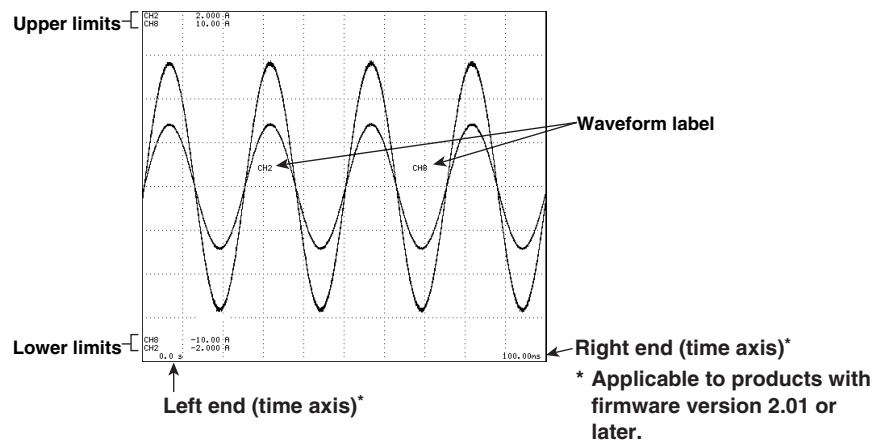

---

## 1.7 Numerical Computation

By making use of the measurement function data and the measurement and computation function (see section 1.2), additional numerical computation can be carried out. In addition, a function is provided in which the equation used in determining the measurement function data can be selected.

### **Delta Computation** «For procedures, see section 10.2.»

In the normal measurement mode, the sum or difference of the instantaneous values (sampled data) of the voltage or current between elements 1, 2, and 3 can be used to determine the measurement functions,  $\Delta U_{rms}$ ,  $\Delta I_{rms}$ ,  $\Delta U_{mn}$ ,  $\Delta I_{mn}$ ,  $\Delta U_{dc}$ ,  $\Delta I_{dc}$ ,  $\Delta U_{ac}$ , and  $\Delta I_{ac}$ . This is called delta computation. The delta computation can be used, for example, to perform star-to-delta transformation of a three-phase AC circuit. For the equation, see Appendix 3. The measurement and computation periods are the same as those described in section 1.2, "Measurement Modes and Measurement/Computation Periods."

### **User-defined Functions** «For procedures, see section 10.3.»

An equation can be created (defined) by combining the measurement function symbols and operators. The numerical data corresponding to the equation can then be determined. The combination of a measurement function and element number ( $U_{rms1}$ , for example) constitutes an operand.

Four equations (F1 to F4) can be defined for each measurement mode (normal and harmonic).

#### **Operators**

There are 11 types of operators: +, -, \*, /, ABS (absolute value), SQR (square), SQRT (square root), LOG (logarithm), LOG10 (common logarithm), EXP (exponent), and NEG (minus sign).

#### **Operands**

There can be up to 16 operands in one equation.

### **Equation for the Apparent Power** «For procedures, see section 10.4.»

The apparent power is determined by the product of the voltage and current. The voltage and current can be selected from the three types, the true rms value, the rectified mean value calibrated to the rms value, and the simple average as explained in "Determining the voltage and current" in section 1.2, "Measurement Modes and Measurement/Computation Periods."

**Averaging** «For procedures, see section 10.5.»

The numerical data can be exponentially averaged using a specified attenuation constant. This function is useful when the numerical display is fluctuating and is hard to read such as when the fluctuation of the power supply or load is large or when the frequency of the input signal is low. The averaging is performed according to the following equation.

$$D_n = D_{n-1} + \frac{(M_n - D_{n-1})}{K}$$

$D_n$  : Displayed value at the  $n$ th time that has been exponentially averaged. (The displayed value  $D_1$  on the first time is  $M_1$ .)

$D_{n-1}$  : Display value at the  $n-1$  time that has been exponentially averaged.

$M_n$  : Measured data at the  $n$ th time.

$K$  : Attenuation constant (Select 2, 4, 8, 16, 32, or 64)

**Phase Difference** «For procedures, see section 10.6.»

The display format of the phase difference of the voltage and current can be selected. With the reference axis set to zero degrees, one format displays the phase difference using  $360^\circ$  in the clockwise direction, and the other format displays an lead of  $180^\circ$  in the counter-clock wise direction and a lag of  $180^\circ$  in the clockwise direction.

**Equation for the Distortion Factor «For procedures, see section 10.8.»**

The measurement functions, Uhdf, lhdf, Phdf, Uthd, lthd, and Pthd of the harmonic measurement mode have two defining equations. The appropriate equations can be selected. For the equations, see Appendix 2.

**Corrected Power «For procedures, see section 10.4.»**

Depending on the applicable standard, when the load that is connected to the potential transformer is extremely small, the active power of the potential transformer that is measured need to be compensated. The compensating equation and the coefficient can be selected.

**IEC76-1(1976), IEEE C57.12.90-1993**

$$P_c = \frac{P}{P_1 + P_2 \left( \frac{U_{rms}}{U_{mn}} \right)^2}$$

**IEC76-1(1993)**

$$P_c = P \left( 1 + \frac{U_{mn} - U_{rms}}{U_{mn}} \right)$$

P<sub>c</sub> : Corrected Power

P : Active power

U<sub>rms</sub> : True rms voltage

U<sub>mn</sub> : Voltage (rectified mean value calibrated to the rms value)

P<sub>1</sub>, P<sub>2</sub> : Coefficient as defined in the applicable standard

**Re-computing the numerical data «For procedures, see section 10.1.»**

With the data acquisition stopped, the measurement/computation period or numerical computation setting can be changed for re-computation. All computations are performed again including the measurement function data.

## 1.8 Waveform Analysis

The displayed waveform can be added or subtracted. A FFT can be performed to display the power spectrum. Furthermore, a cursor can be placed on the waveform to measure the value at that point.

### Waveform Computation «For procedures, see section 11.2.»

An equation can be created by combining the symbols of each channel and operators. The resultant waveform of the equation can be displayed. Two types of equations can be created using the operands, C1 through C8, that correspond to CH1 through CH8. Up to 16 operands can be used in one equation. The starting and ending points can be specified, and the computation is performed over that region.

The operators are +, -, \*, /, ABS (absolute value), SQR (square), SQRT (square root), LOG (logarithm), LOG10 (common logarithm), EXP (exponent), NEG (minus sign), DIF (differentiation, applicable to products (PZ4000) with firmware version 2.01 or later). TINTG, TREND, AVG, SSP, SLIP, PM are available as special functions. TINTG is counted as two operands.

#### TINTG

The sampled data are integrated according to the following equation.

$$X_n = X_{n-1} + d_n \times t$$

$X_n$  : nth display data. (The first display data,  $x_1$ , is  $d_1 \times t$ .)

$X_{n-1}$  : n-1th display data that has been integrated.

$d_n$  : nth sampled data.

$t$  : sampling period (inverse of the sampling rate). When the time base is set to external clock or when the measurement mode is harmonic,  $t = 1$  s.

#### TREND

The instantaneous value (sampled data) of the measured signal can be computed (in the same fashion as determining each measurement function) for each cycle of the synchronized signal, and the TREND waveforms of the following measurement functions can be displayed.

Measurement Function that Can Be Computed	Applicable Function	Channel Symbol Placed Inside the Parentheses
True rms value and active power (Urms, Irms, and P)	TREND( )	C1, C2, C3, C4, C5, C6, C7, C8, C1*C2, C3*C4, C5*C6, C7*C8
Rectified mean value calibrated to the rms value (Umn and Imn)	TRENDM( )	C1, C2, C3, C4, C5, C6, C7, C8
Simple average (Udc and Idc)	TREND( )	C1, C2, C3, C4, C5, C6, C7, C8
Frequency (fU and fI)	TRENDF( )	C1, C2, C3, C4, C5, C6, C7, C8

\* Functions TRENDM, TREND( ), and TRENDF are applicable to products (PZ4000) with firmware version 2.01 or later.

The synchronizing signal varies depending on the channel symbol that is entered in the parentheses of each function.

Channel Symbol	Synchronizing Signal
C1, C2, C1*C2	Signal selected for ELEMENT1 in the zero crossing setting of the measurement/computation period.
C3, C4, C3*C4	Signal selected for ELEMENT2 in the zero crossing setting of the measurement/computation period.
C5, C6, C5*C6	Signal selected for ELEMENT3 in the zero crossing setting of the measurement/computation period.
C7, C8, C7*C8	Signal selected for ELEMENT4 in the zero crossing setting of the measurement/computation period.

\* If the motor module is installed in slot 4, C7, C8, C7\*C8 cannot be specified.

1.8 Waveform Analysis

Example of an equation used to display the TREND waveform of Umn of element 1 and the waveform

Equation: TRENDM(C1)

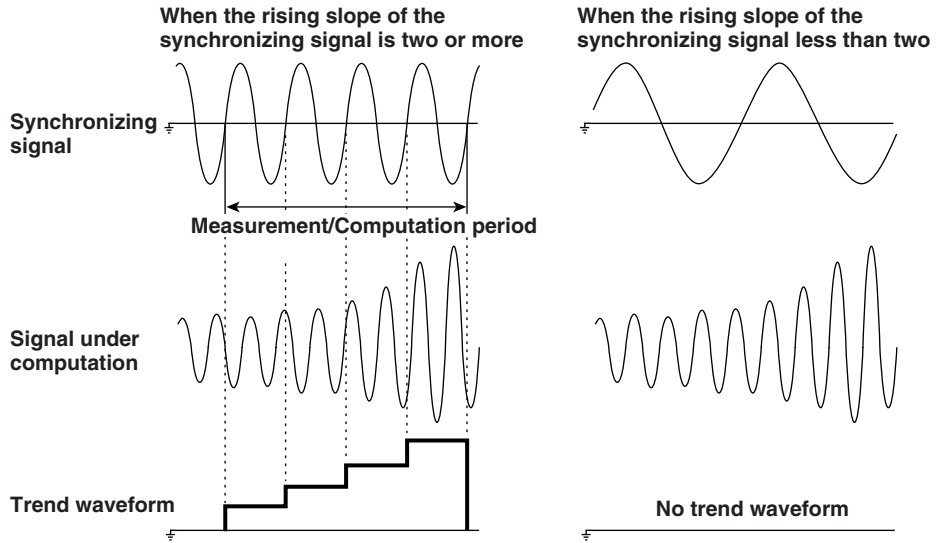

AVG

The rms values of voltage and current and the instantaneous value (sampled data) of active power can be exponentially averaged using a specified attenuation constant and the waveform can be displayed. The items are averaged according to the following equation.

Example of an AVG function

AVG(C1\*C2) : Displays the AVG waveform of the active power of element 1.

$$x_n = x_{n-1} + \frac{(d_n - x_{n-1})}{k}$$

$x_n$  : Displayed value at the nth time. (The displayed value of  $x_1$  on the first time is  $d_1$ .)

$x_{n-1}$  : Display value at the n-1 time that has been exponentially averaged.

$d_n$  : Sampled data at the nth time.

$k$  : Attenuation constant (Select 2, 4, 8, 16, 32, or 64)

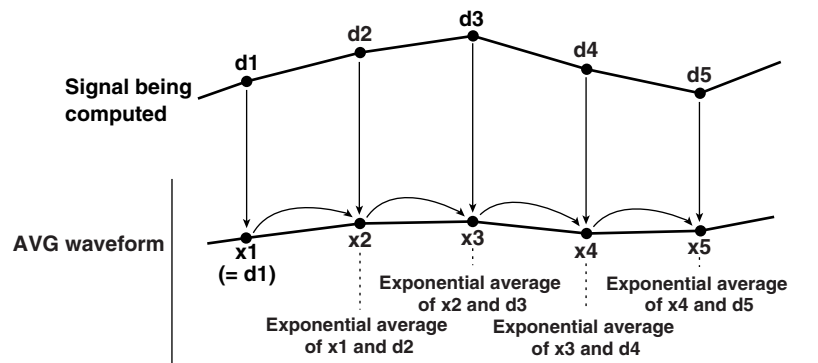

**SSP**

Displays the waveform (changes over time) of the Sync (synchronous speed) function. Sync is one of the measurement functions of the motor module. The waveform is a step function that changes every period of the synchronizing signal (frequency measurement source, see section 15.6) as in the TREND waveform.

**SLIP**

Displays the waveform (changes over time) of the Slip function. Slip is one of the measurement functions of the motor module.

**PM**

Displays the waveform (changes over time) of Pm (motor output, mechanical power). Pm is one of the measurement functions of the motor module.

**Display Scaling of a Computed Waveform «For procedures, see section 11.2.»**

In general, when displaying a computed waveform, auto scaling can be used. With auto scaling, the upper and lower limits of the screen are determined from the maximum and minimum values of the computed result. However, if necessary, manual scaling can also be used in which the upper and lower limits can be set arbitrarily.

**FFT «For procedures, see section 11.3.»**

The power spectrum of the voltage, current, and active power can be displayed by taking the FFT (Fast Fourier Transform). This function is useful for checking the frequency distribution of the voltage, current, and active power.

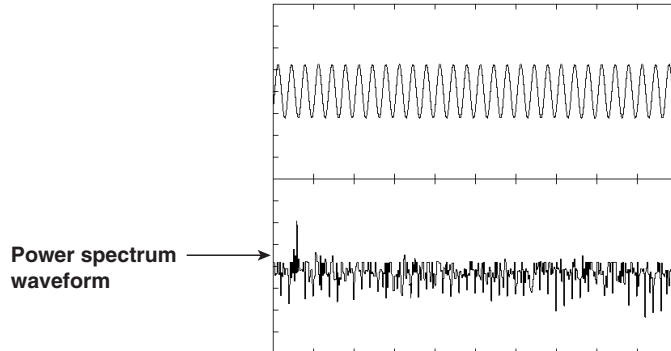

A rectangular window or Hanning window can be selected as the time window. The rectangular window is best suited for transient signals such as impulse waves in which the signal attenuates completely inside the window. The Hanning window gently attenuates the signal near the ends of the window providing continuity in the signal. The extreme ends of the window are set to zero level. The Hanning window is best suited for continuous signals.

A FFT is performed on the sampled data of 1000, 2000, or 10000 points to give 500, 1000, or 5000 points of data, respectively, and the result is displayed.

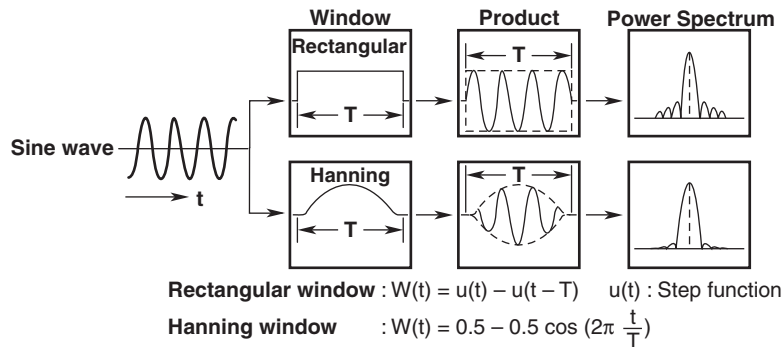

**Note**

**FFT**

The power spectrum is expressed using the following equation.

Take the complex function of the voltage after taking the FFT to be  $U = U_r + jU_j$ , and the complex function of the current to be  $I = I_r + jI_j$ .

$$\text{Voltage power spectrum} = \sqrt{\frac{U_r^2 + U_j^2}{2}}$$

$$\text{Current power spectrum} = \sqrt{\frac{I_r^2 + I_j^2}{2}}$$

$$\text{Power spectrum of the active power} = U_r I_r + U_j I_j$$

$U_r, I_r$  : Real Part       $U_j, I_j$  : Imaginary Part

**The difference between a harmonic measurement and a FFT on this instrument**

In the harmonic measurement, the signal is sampled at a sampling rate that is in sync with the PLL source. The signal components that are integer multiples of the fundamental signal are measured. Therefore, the harmonic measurement is best suited to measuring signals that contain a fundamental frequency component with its associated harmonics. It can be used to determine the impedance for each harmonic order as well as the sum of all harmonic signals. With the FFT, the signal is sampled at a fixed sampling rate determined by the observation time and the memory size. The FFT contains frequency information up to half the bandwidth of the sampling rate. Therefore, the FFT is best suited for analyzing signals that include components other than integer multiples of the fundamental signal (distorted waves and noise). It can be used to display the power spectrum with a frequency resolution of 500, 1000, or 5000 points.



**Re-computing the Waveform** «For procedures, see section 11.1.»

With the data acquisition stopped, the starting and ending points of the computation or waveform computation setting can be changed for re-computation of the waveform and of the FFT.

**Cursor measurements** «For procedures, see section 11.4.»

By placing markers or cursors on the displayed waveform, the values at the point can be measured and displayed. It can be used to measure the voltage and current for various sections of the waveform or the data on the horizontal axis (X axis). Cursor measurements are performed on the data that are displayed on the screen.

**Marker**

“+” and “x” marks are displayed on the specified waveform. These are markers. The vertical value and the horizontal value from the left edge of the screen for each marker, as well as the differences between the vertical values and the horizontal values of the markers can be measured.

**H cursors (horizontal cursors)**

Two dotted horizontal lines are displayed. These are H cursors. The vertical value of each H cursor and the difference between them can be measured.

**V cursors (vertical cursors)**

Two dotted vertical lines are displayed. These are V cursors. The horizontal value from the left edge of the screen to each V cursor and the horizontal value difference between them can be measured.

**Markers**

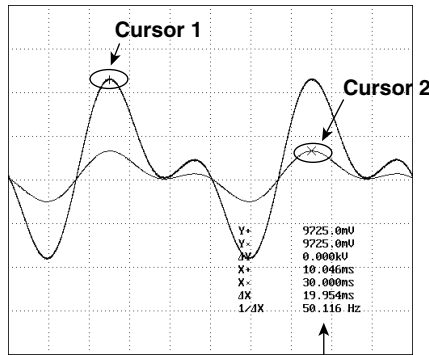

Measured values

**H Cursors**

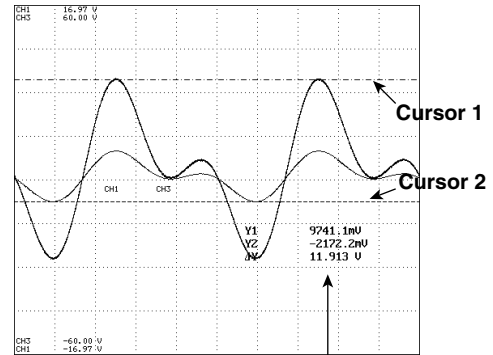

Measured values

**V Cursors**

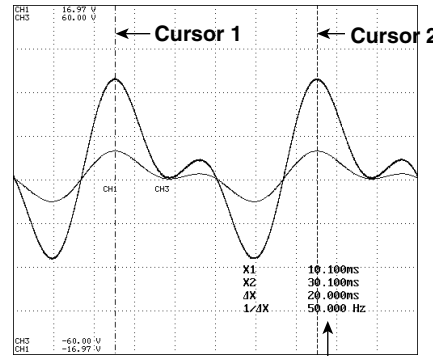

Measured values

**H & V Cursors**

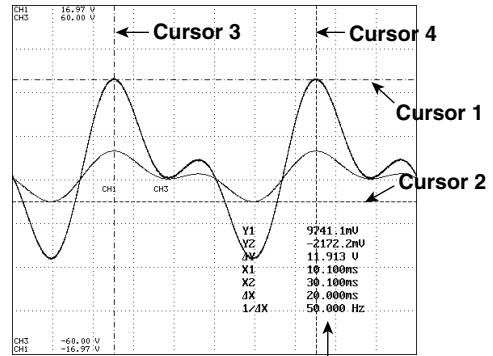

Measured values

## 1.9 Saving/Loading the Data and Other Useful Functions

### Saving/Loading data from a Floppy Disk «For procedures, see chapter 12.»

A floppy disk drive comes standard with the instrument. Numerical data, waveform data as well as setup parameters can be saved and loaded as necessary. In addition, screen image data can be saved in TIFF, BMP, and PS (PostScript) formats. The screen image data can be attached to documents using a word processing application.

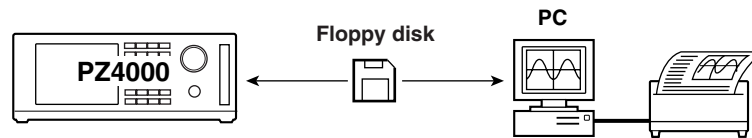

### Saving/Loading from a SCSI Device «For procedures, see chapter 12.»

On instruments with the SCSI option (suffix code /C7), various data can be saved or loaded from an external SCSI device\* in the same manner described above for the floppy disk. This is useful when handling large amounts of data.

\* Zip disk, hard disk drive, MO disk, PD disk, etc.

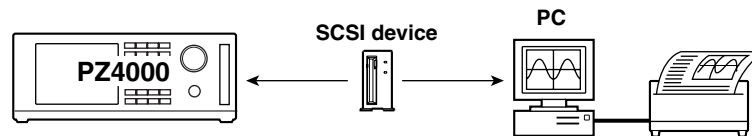

### Initialization «For procedures, see section 4.2.»

The various setup parameters configured using operation keys and soft keys can be initialized to their factory default values. For details regarding the initial settings, see Appendix 4, "List of Initial Settings and Display Order of Numerical Data."

### Outputting Screen Image Data «For procedures, see chapter 13.»

Screen image data can be output to various recording media such as the built-in printer, an external printer (that support Centronics), a floppy disk, or a SCSI device.

#### Built-in printer (option)

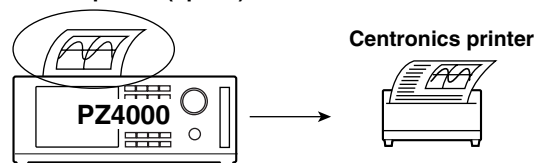

**Selecting the Message Language** «For procedures, see section 14.2.»

The language for the error and help messages that are displayed during operation can be selected. The choices are English and Japanese.

**Setting the Brightness of the LCD monitor** «For procedures, see section 14.2.»

The brightness of the LCD monitor can be adjusted.

**Setting the Display Colors** «For procedures, see section 14.3.»

The colors for graphical elements such as the waveform, background, scale, and cursor and text elements such as the menu and the menu background can be selected. The colors are set using RGB percentages.

**Action-on-Trigger** «For procedures, see section 14.4.»

The specified operation is carried out whenever a trigger occurs.

- Save numerical data, waveform data, and setup parameters to the specified medium.
- Output or save the screen image data to the specified destination.

**Self-test Function** «For procedures, see section 15.3.»

A self-test can be performed to check whether or not the instrument is operating properly. Components such as the memory, the operation keys, the floppy disk drive, and the built-in printer (option) can be tested.

**Confirming the System Condition of the Instrument**

«For procedures, see section 15.4.»

The system condition of the instrument such as the model, ROM version (firmware version), module configuration, and existence of options can be confirmed.

**Communication Function (GP-IB/Serial)**

«See Communication Interface User's Manual IM253710-11E.»

A GP-IB interface and a serial interface (complies with EIA-574 Standard (EIA-232 (RS-232) standard for 9 pin)) come standard with the instrument. The communication function can be used to transfer data to a PC for analysis or to control the instrument with an external controller.

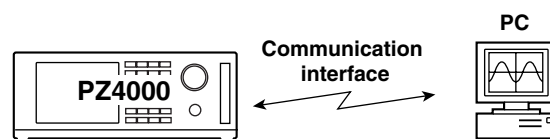

# 2.1 Front Panel, Rear Panel, and Top View

## Front Panel

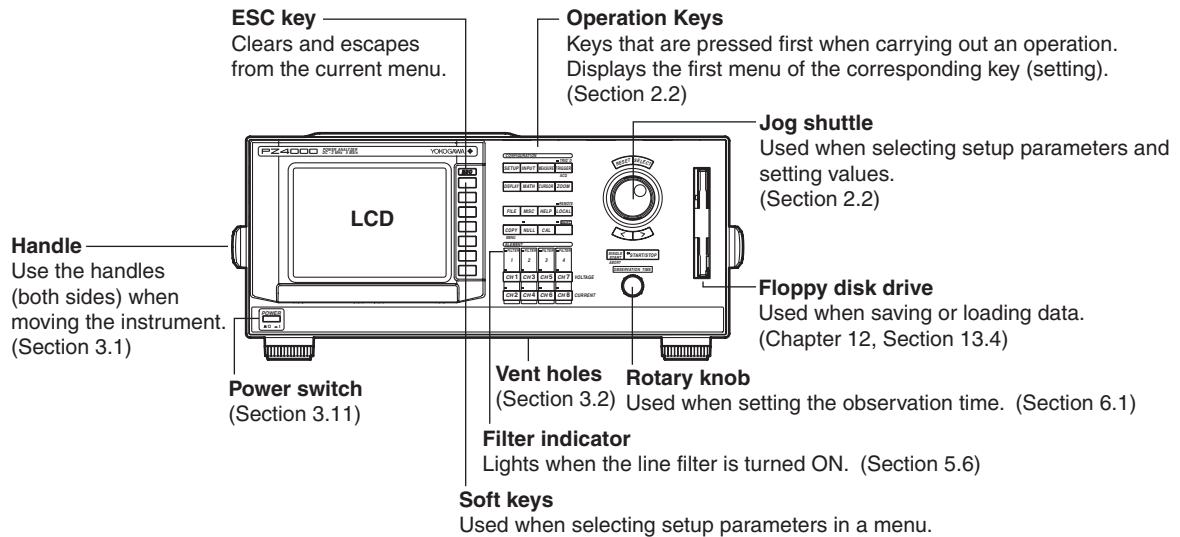

## Rear Panel

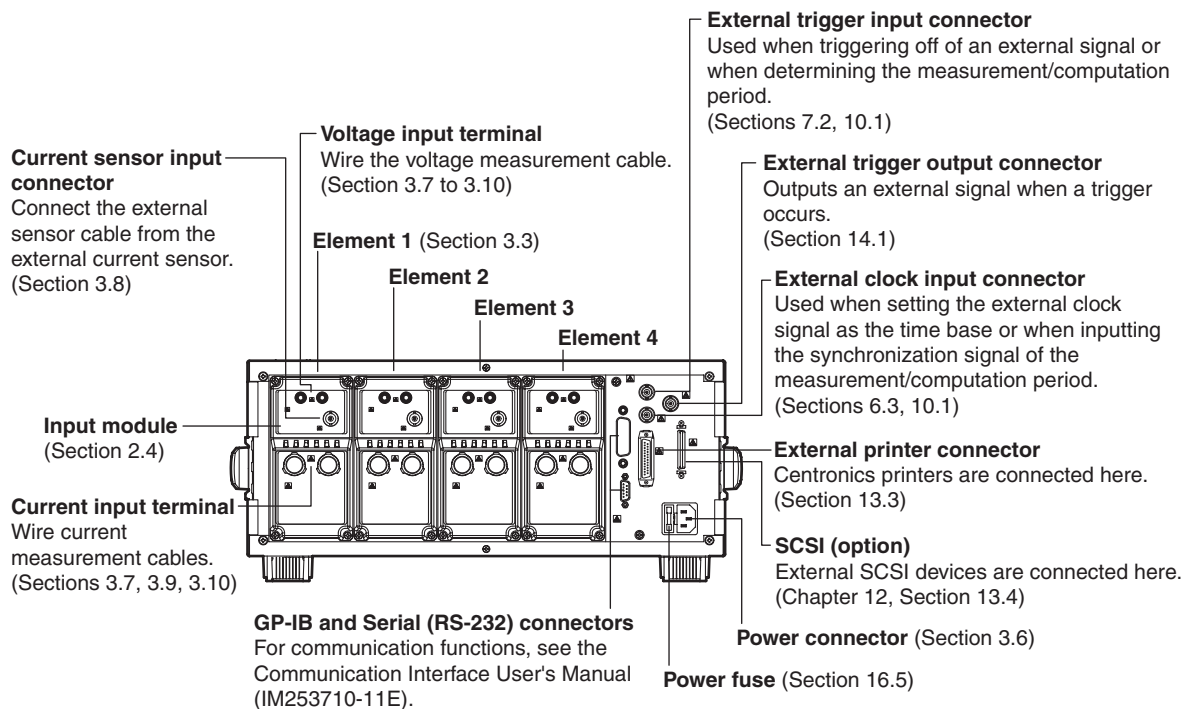

\* A sensor input module can be installed into the element number 4 slot. The input terminal or connector type varies depending on the type of sensor input module that is installed. For details related to the connector types, see section 2.4.

## 2.1 Front Panel, Rear Panel, and Top View

---

### Top View

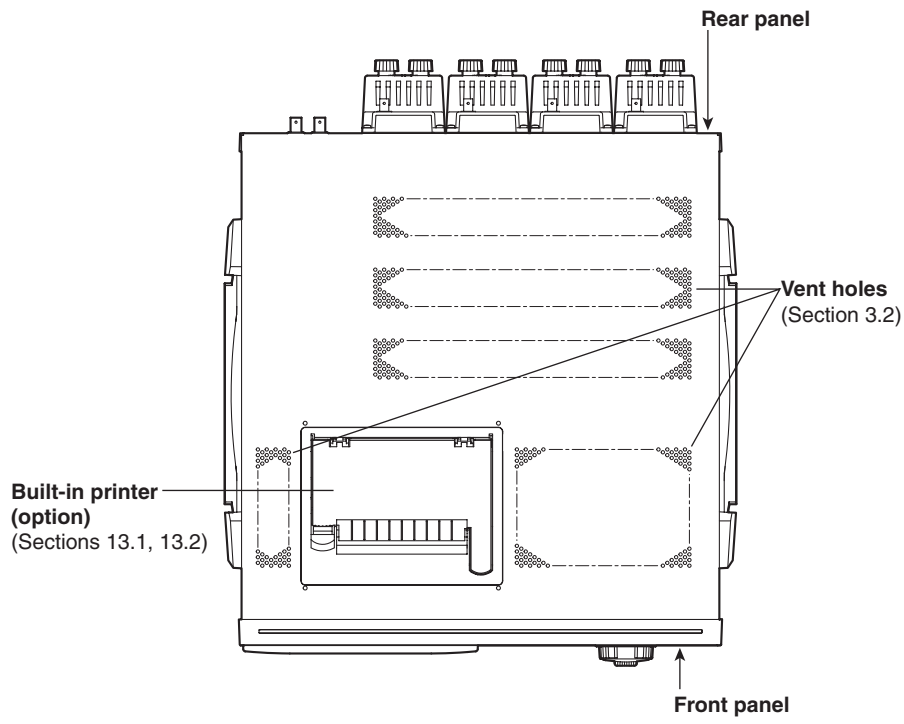

## 2.2 Operation Keys, Jog Shuttle, and Rotary Knob

### Common to All Functions

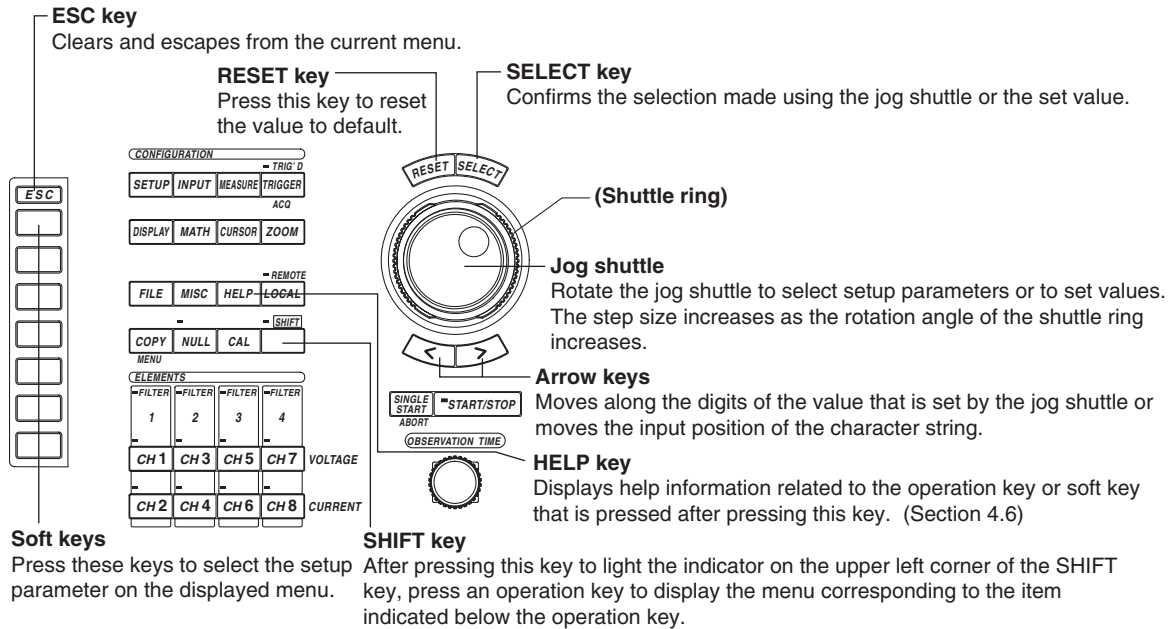

### Set Measurement Mode, Acquisition Conditions of Measured Data, and Trigger

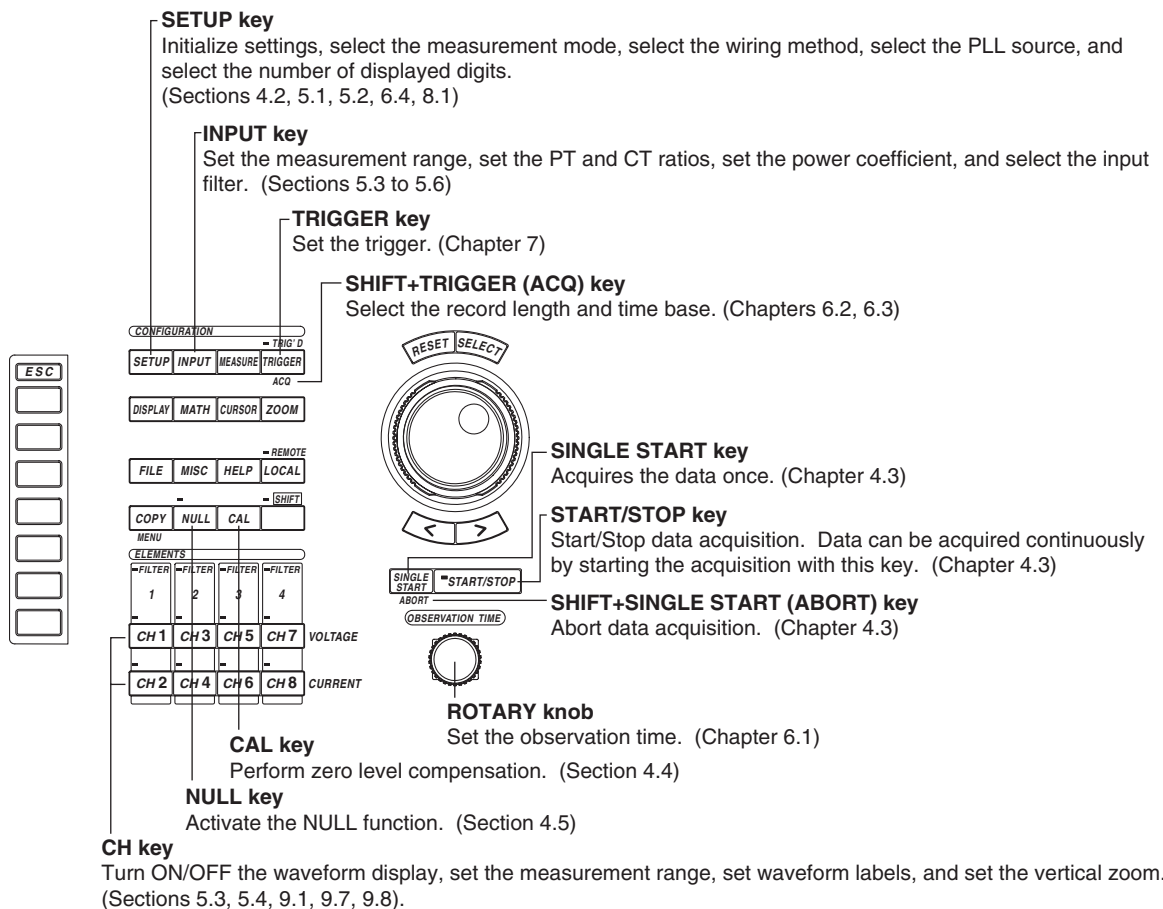

## 2.2 Operation Keys, Jog Shuttle, and Rotary Knob

### Set Numerical Display and Waveform Display

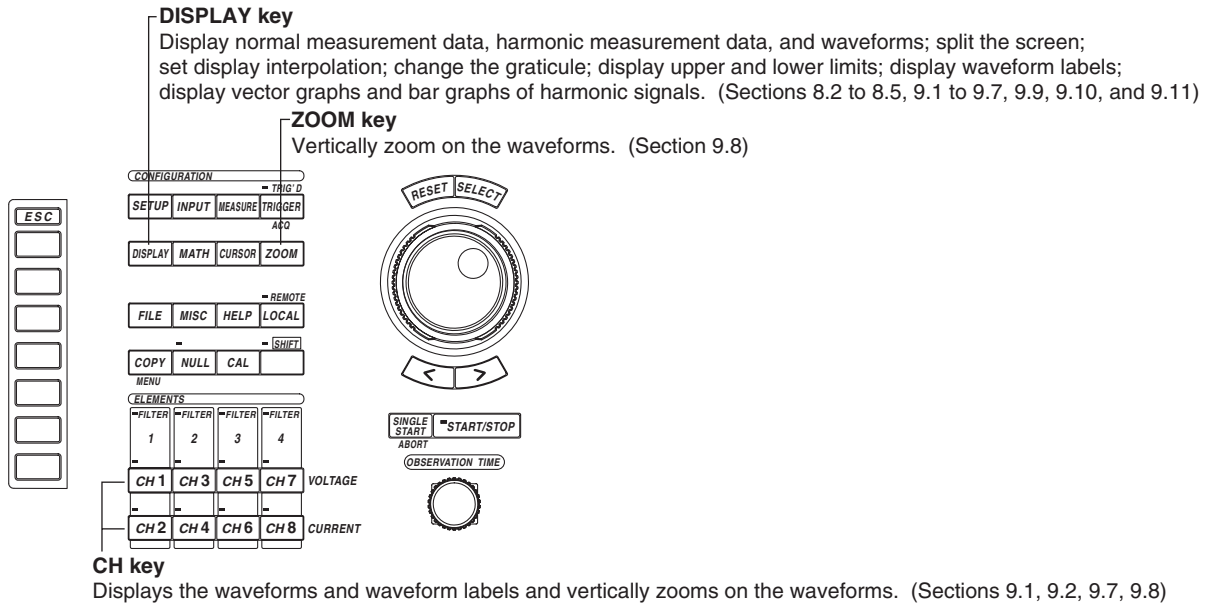

### Set Numerical Computation and Waveform Analysis

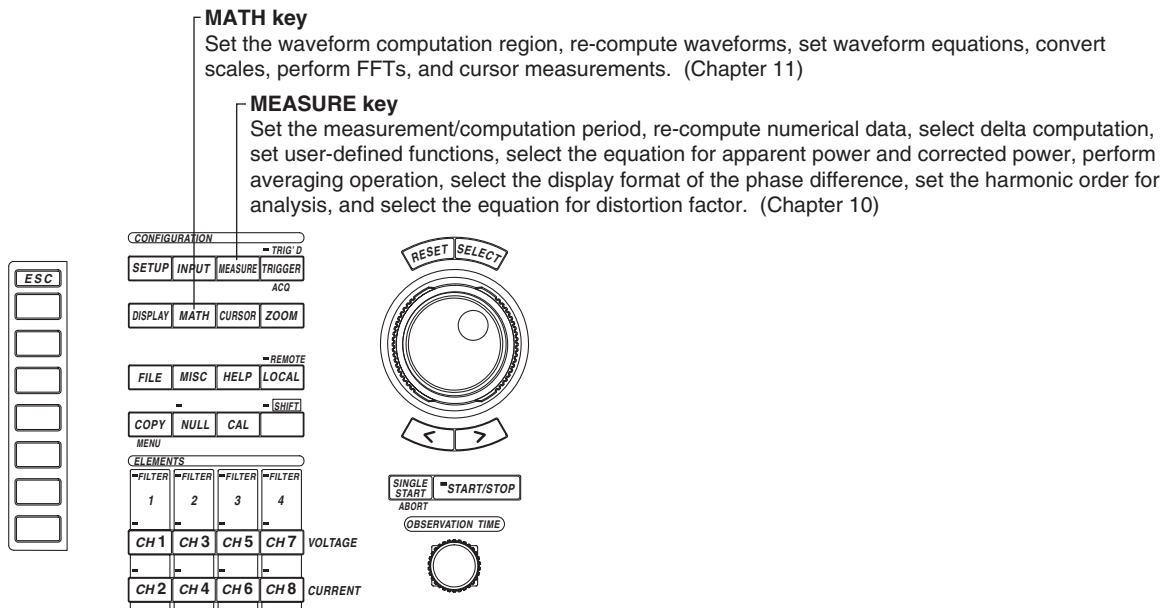

### Save and Load data, and Set Other Functions

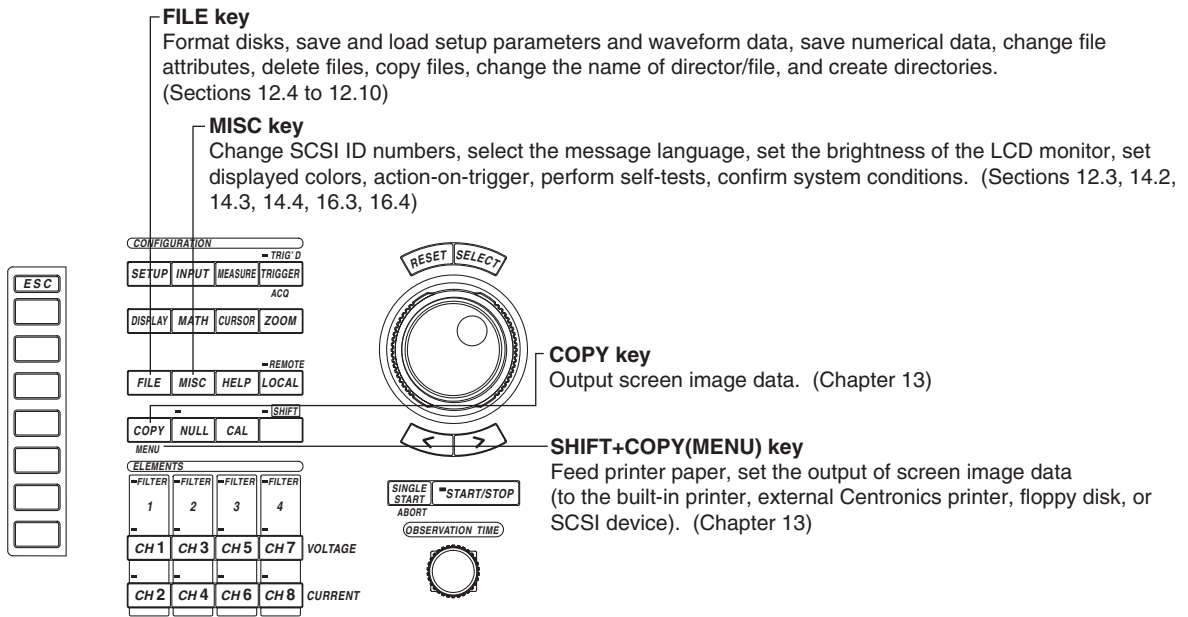



## 2.3 Screens

### Numerical Display for the Normal Measurement Mode

#### 8 items display

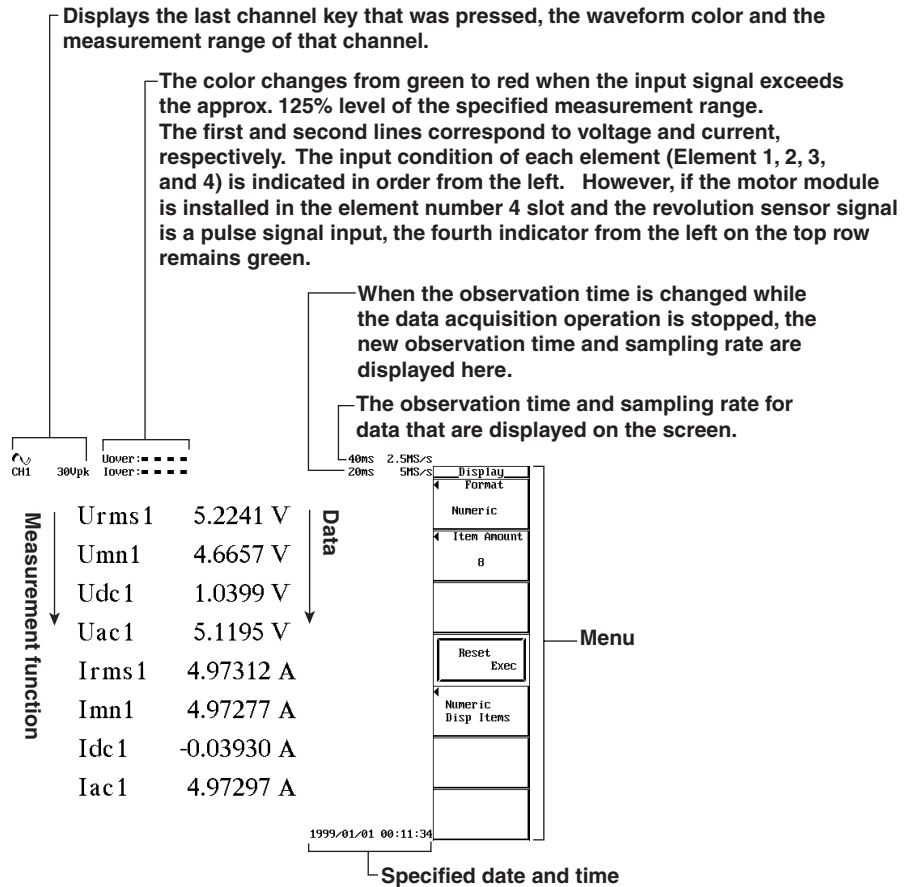

#### 16 items display

Urms1	5.2241 V	P1	-0.094 W
Umn1	4.6657 V	1	25.980 VA
Udc1	1.0399 V	1	25.980 var
Uac1	5.1195 V	1	-0.00361
Irms1	4.97312 A	1	90.207 °
Imn1	4.97277 A	fU1	50.02 Hz
Idc1	-0.03930 A	fI1	1.000kHz
Iac1	4.97297 A	U-pk1	9.8576 V

Measurement function

Data

42 items display

Urms1	5.2241 U	f11	1.000kHz	Pc1	-0.083 M
Umn1	4.6657 U	U-pk1	9.8576 U	q1	-----
Udc1	1.0399 U	I-pk1	-7.7754 U	I-q1	-----
Uac1	5.1195 U	I-pk1	7.16912 A	F1	-----
Irms1	4.97312 A	I-pk1	-7.27178 A	F2	-----
I-m1	4.97277 A		1.887	F3	-----
I-dc1	-0.03930 A		1.462	F4	-----
I-ac1	4.97297 A	FFU1	1.244	UUrms1	0.0413 U
P1	-0.094 W	FF11	1.111	UUm1	0.0365 U
S1	25.980 VA	Z1	1.05046 Ω	Udc1	0.0111 U
Q1	25.980 var	Rs1	-3.79359m	Uac1	0.0398 U
λ1	-0.00361	Xs1	1.05046	UIrms1	-----
φ1	90.207 °	Rp1	-290.879	UI-m1	-----
FU1	50.02 Hz	Xp1	1.05047	UI-dc1	-----

78 items display

Urms1	5.2241 U	Rp1	-290.879	Udc2	1.0150 U
Umn1	4.6657 U	Xp1	1.05047	Uac2	5.0407 U
Udc1	1.0399 U	Pc1	-0.083 M	Irms2	0.0000A
Uac1	5.1195 U			I-m2	0.0000A
Irms1	4.97312 A			I-dc2	0.049nA
I-m1	4.97277 A			I-ac2	0.0000A
I-dc1	-0.03930 A			P2	0.00005 W
I-ac1	4.97297 A			S2	0.00000 VA
P1	-0.094 W			Q2	0.00000 var
S1	25.980 VA	s1	0.0413 U	λ2	Error
Q1	25.980 var	1	0.0365 U	φ2	Error
λ1	-0.00361	1	0.0111 U	FU2	50.00 Hz
φ1	90.207 °	1	0.0398 U	F12	0.0000Hz
FU1	50.02 Hz	s1	-----	U-pk2	9.7975 U
F11	1.000kHz	UI-m1	-----	U-pk2	-7.7806 U
U-pk1	9.8576 U	UI-dc1	-----	I-pk2	1.0500A
U-pk1	-7.7754 U	UI-ac1	-----	I-pk2	-0.895nA
I-pk1	7.16912 A			CFU2	1.905
I-pk1	-7.27178 A			CF12	Error
CFU1	1.887			FFU2	1.256
CF11	1.462			FF12	Error
FFU1	1.244			Z2	Error
FF11	1.111			Rs2	Error
Z1	1.05046 Ω			Xs2	Error
Rs1	-3.79359m	Urms2	5.1418 U	Rp2	482.521k
Xs1	1.05046	Umn2	4.5488 U	Xp2	Error

All display

Element and wiring method						
	Element1	Element2	Element3	Element4	Σ A	Σ B
Urms(U)	5.2241	5.1418	5.1577	5.2681	5.2241	5.1418
Umn(U)	4.6657	4.5488	4.5635	4.7438	4.6657	4.5488
Udc(U)	1.0399	1.0150	1.0259	1.2703	1.0399	1.0150
Uac(U)	5.1195	5.0407	5.0546	5.1127	5.1195	5.0407
Irms(A)	4.97312	0.000n	0.000n	24.9324	4.97312	0.000n
I-m(A)	4.97277	0.000n	0.000n	24.9297	4.97277	0.000n
I-dc(A)	-0.03930	0.049n	0.044n	-0.2221	-0.03930	0.049n
I-ac(A)	4.97297	0.000n	0.000n	24.9314	4.97297	0.000n
P(W)	-0.094	0.00005	0.00005	0.00001k	-0.094	0.00005
S(VA)	25.980	0.00000	0.00000	0.13135k	25.980	0.00000
Q(var)	25.980	0.00000	0.00000	0.13135k	25.980	0.00000
λ	-0.00361	Error	Error	0.00000	-0.00361	Error
φ(°)	90.207	Error	Error	89.996	90.207	Error
FU(HZ)	50.02	50.00	50.00	50.04	-----	-----
f1(HZ)	1.000k	0.000n	0.000n	1.000k	-----	-----
U-pk(U)	9.8576	9.7975	9.8654	9.9788	-----	-----
U-pk(U)	-7.7754	-7.7806	-7.7859	-7.6726	-----	-----
I-pk(A)	7.16912	1.058n	0.881n	35.7969	-----	-----
I-pk(A)	-7.27178	-0.895n	-0.889n	-36.2547	-----	-----
CFU	1.887	1.905	1.913	1.894	-----	-----
CF1	1.462	Error	Error	1.454	-----	-----
FFU	1.244	1.256	1.255	1.233	-----	-----
FF1	1.111	Error	Error	1.111	-----	-----
Z	1.05046	Error	Error	211.298n	1.05046	Error
Rs	-3.79359m	Error	Error	0.0000	-3.79359m	Error

### Numerical Display during the Harmonic Measurement Mode

#### 8 items display

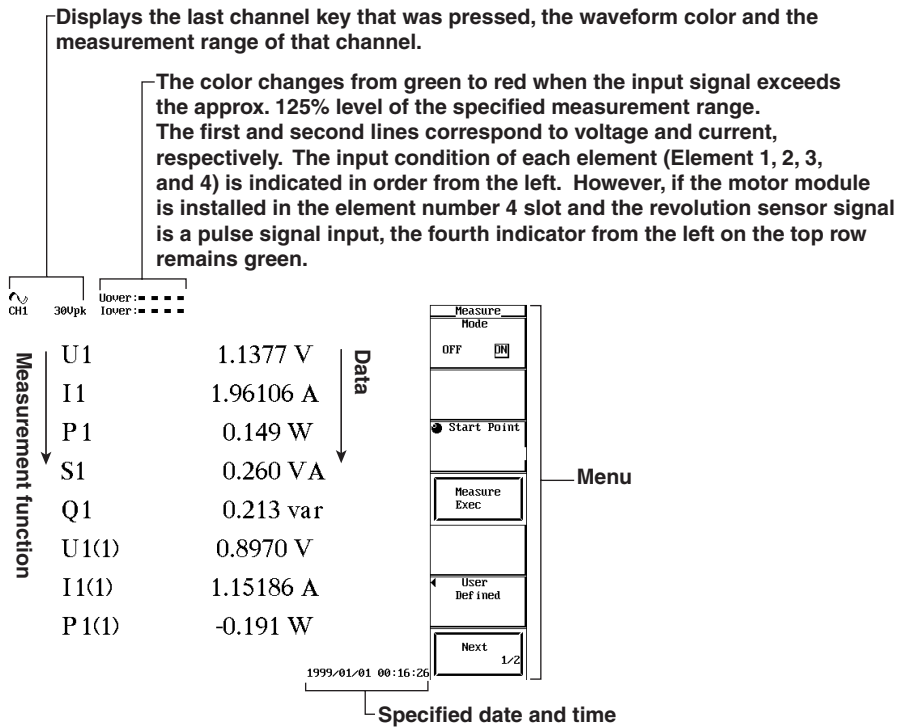

#### 16 items display

Measurement function	U1	1.1377 V	S1(1)	1.033 VA
	I1	1.96106 A	I1(1)	1.015 var
	P1	0.149 W	P1(1)	-0.18486
	S1	0.260 VA	S1(1)	100.653 °
	Q1	0.213 var	Q1(1)	-2.260 °
	U1(1)	0.8970 V	φI1(2)	-89.524 °
	I1(1)	1.15186 A	fU1(1)	-0.000mHz
	P1(1)	-0.191 W	fI1(1)	0.000mHz

Single list

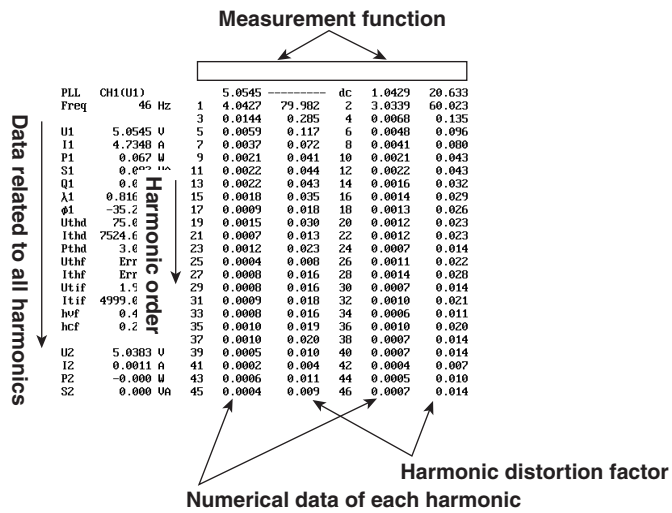

Dual list

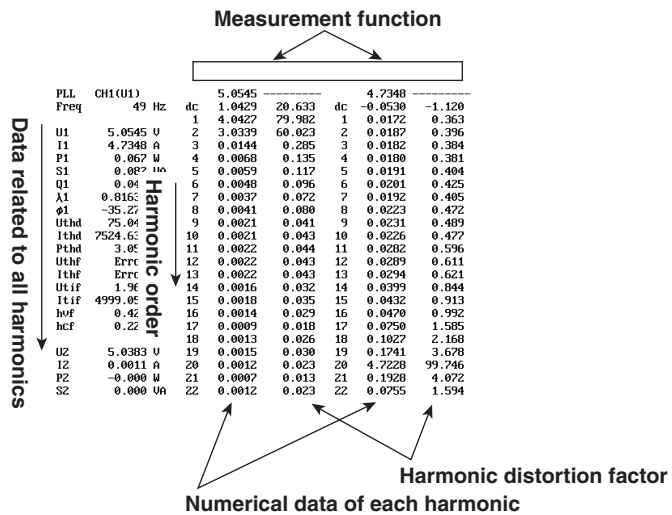

Σ list

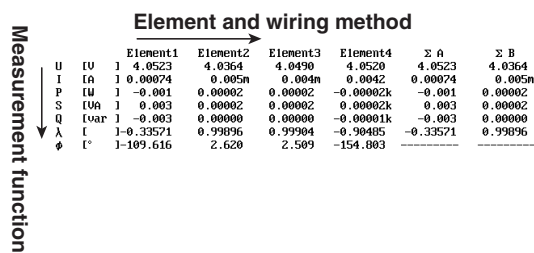

## Waveform Display

### Normal waveform display

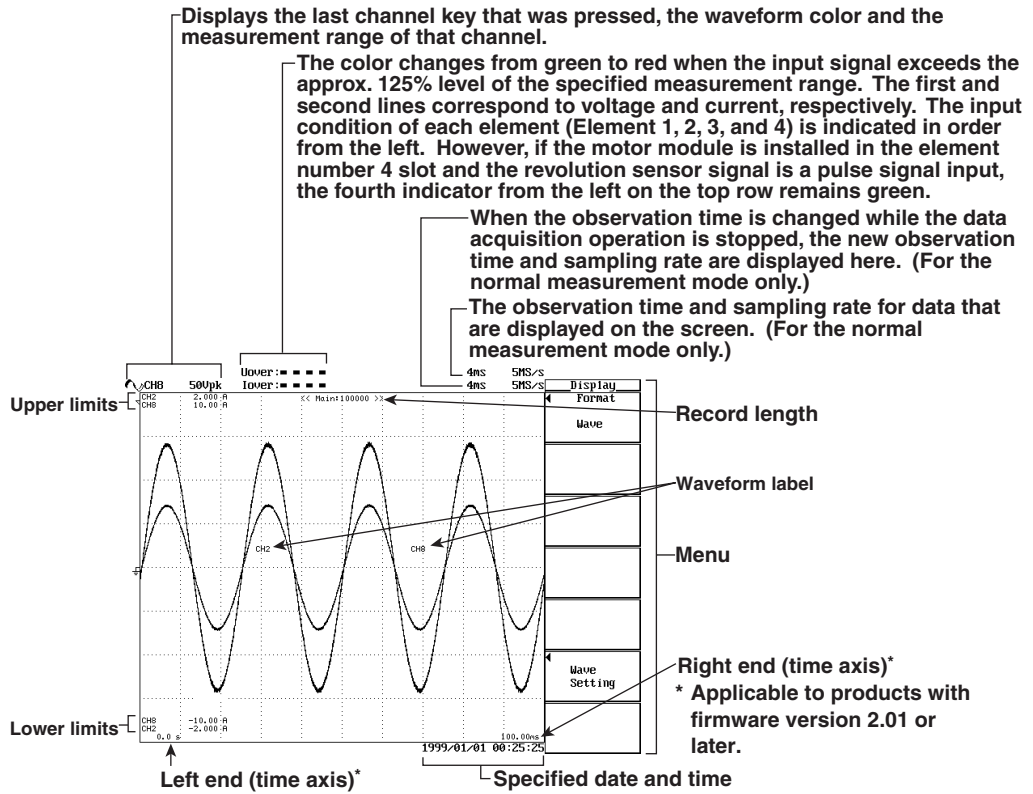

### Zoom display

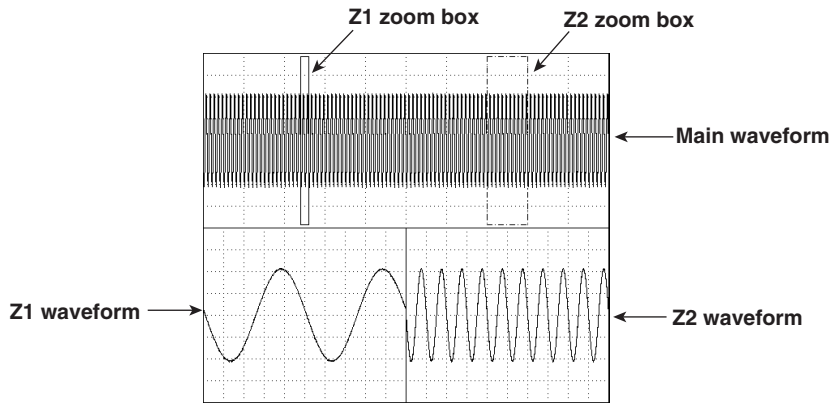

### X-Y waveform display (applicable to products with firmware version 2.01 or later)

Display example when the normal waveform (T-Y waveform) and X-Y waveform are displayed simultaneously

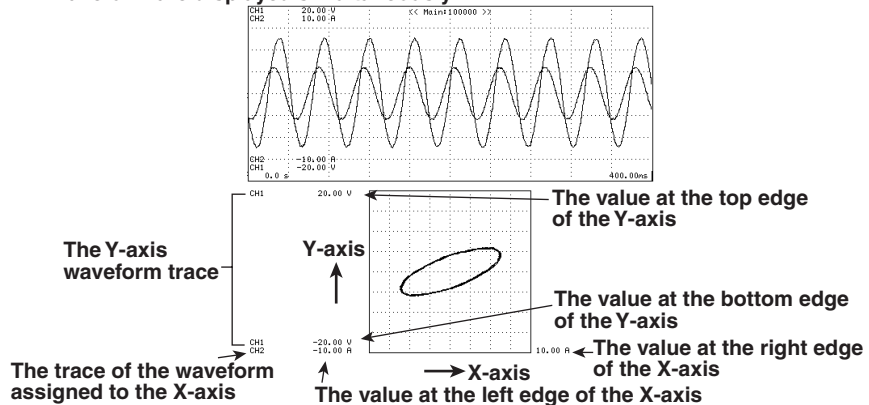

Vector display of harmonics

• When displaying numerical data (the size of the signal and the phase difference between signals)

For a 3P4W (three-phase four-wire) wiring system

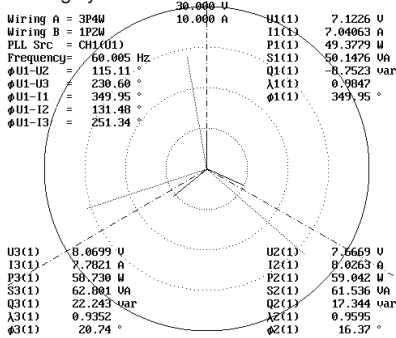

For a 3V3A (three-voltage, three-current) wiring system

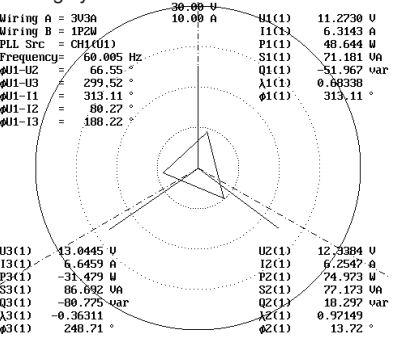

For a 3P3W (three-phase three-wire) wiring system

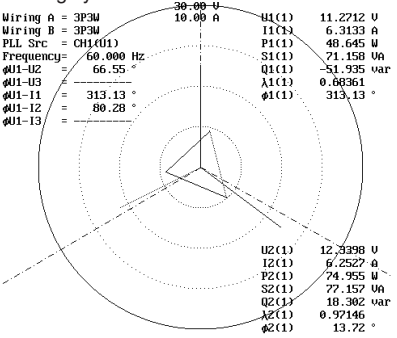

• When not displaying numerical data

For a 3P4W (three-phase four-wire) wiring system

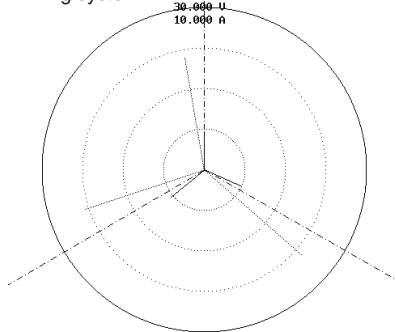

For a 3V3A (three-voltage, three-current) wiring system

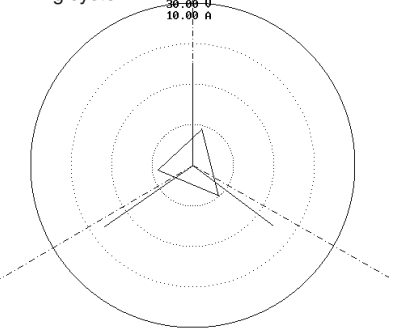

For a 3P3W (three-phase three-wire) wiring system

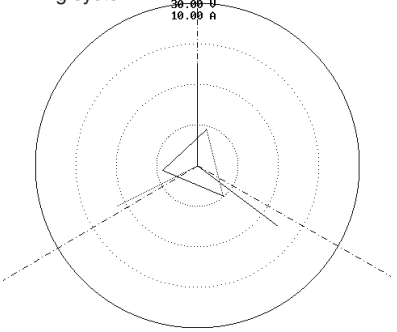

• When the vector size is displayed zoomed (applicable to products with firmware version 2.01 or later)

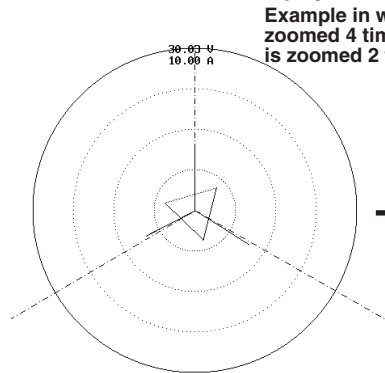

Example in which the voltage is zoomed 4 times and the current is zoomed 2 times.

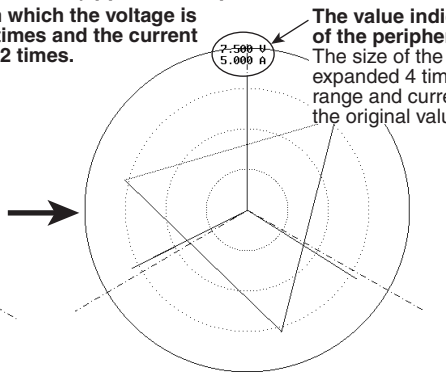

Bar graph display of harmonic data

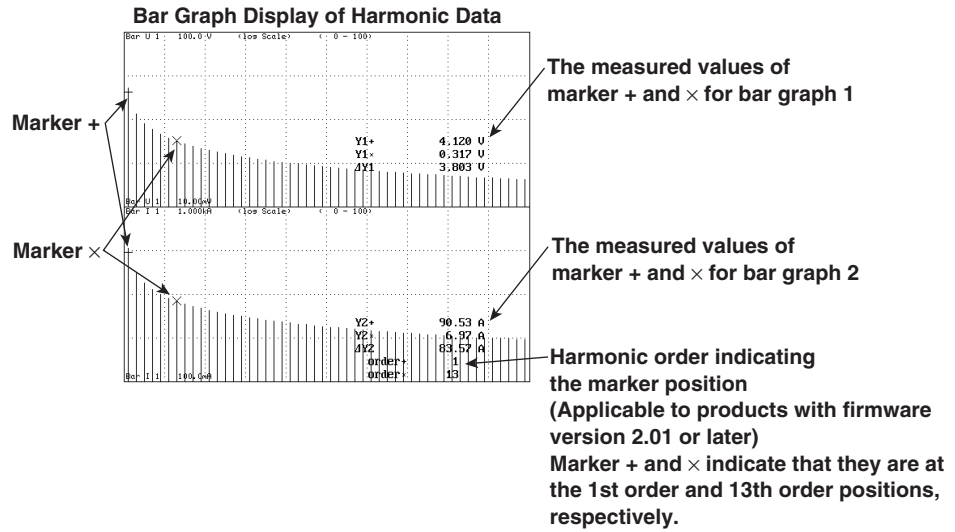

Cursor measurement display

For Markers

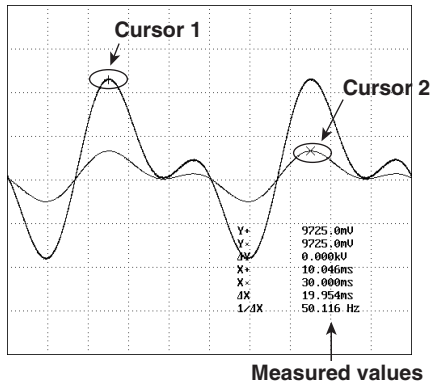

For H Cursors

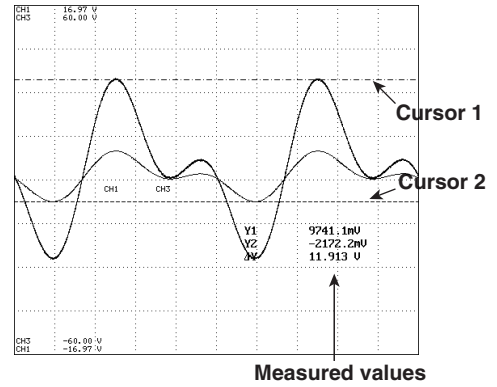

For V Cursors

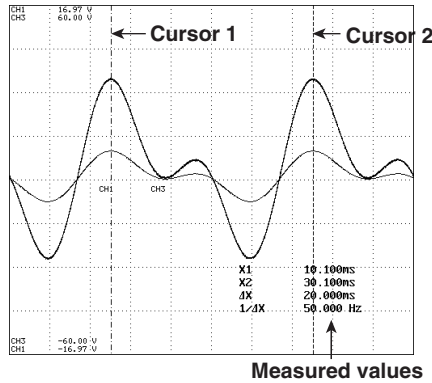

For H & V Cursors

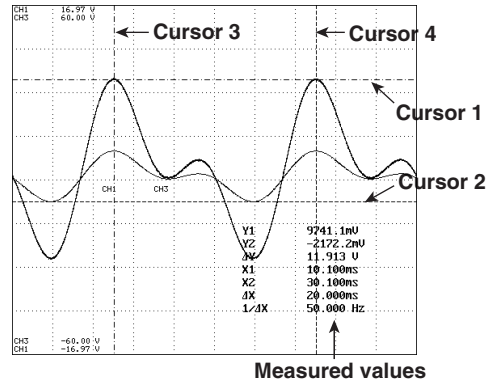

**Simultaneous Displays of Numerical Data and Waveforms**

Urms1	4.6156 V	Irms1	4.97212 A
Umn1	4.2619 V	Imn1	-4.97151 A
Udc1	-3.0163 V	Idc1	-0.03889 A
Uac1	3.4937 V	Iac1	4.97197 A

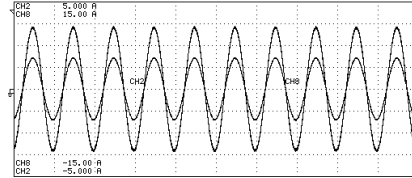

**Simultaneous Displays of Numerical Data and Bar Graphs**

U1	4.567	u	Q1	0.0011	kvar
I1	100.36	A	U1 (1)	4.120	u
P1	0.4584	kW	I1 (1)	90.53	A
S1	0.4584	kVA	P1 (1)	0.3730	kW

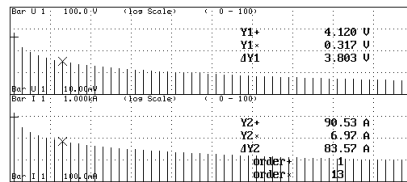



## 2.4 Input Modules

### Power Measurement Module

#### Model 253751

**Voltage input terminal**

Wire the voltage measurement cable.  
(Section 3.7 to 3.10)

**Current sensor input connector**

Connect the external sensor cable from the external current sensor.  
(Section 3.8)

**Current input terminal**

Wire current measurement cables.  
Maximum rating is 5 Arms.  
(Sections 3.7, 3.9)

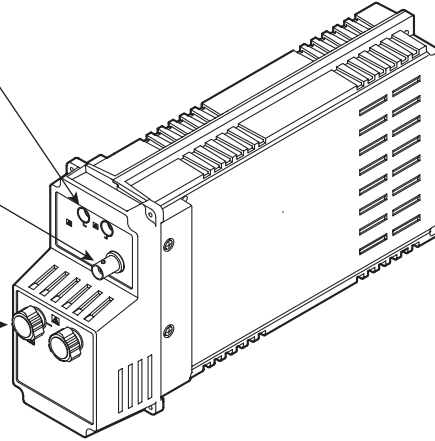

#### Model 253752

**Voltage input terminal**

Wire the voltage measurement cable.  
(Section 3.7 to 3.10)

**Current sensor input connector**

Connect the external sensor cable from the external current sensor.  
(Section 3.8)

**Current input terminal**

Wire current measurement cables.  
Two terminals are available for maximum ratings of 5 Arms and 20 Arms.  
(Sections 3.7, 3.9)

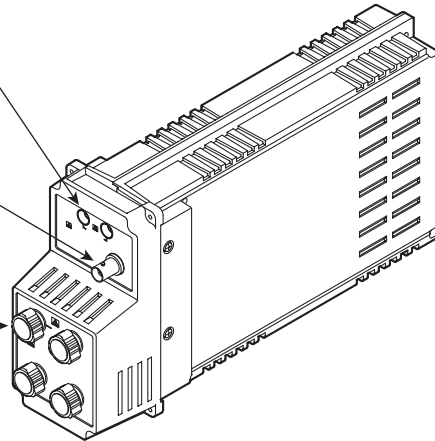

**Sensor input module****Model 253771 (motor module)**

**Revolution sensor signal  
Input connector (CH7)**  
Connect a cable from an  
external revolution sensor.  
(Section 15.1)

**Torque meter signal  
Input connector (CH8)**  
Connect a cable from  
an external torque meter.  
(Section 15.1)

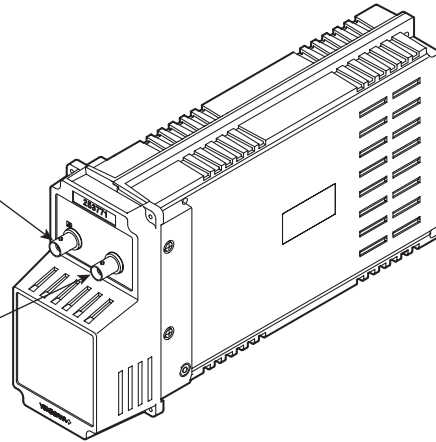

## 3.1 Precautions on the Use of the instrument

### Safety Precautions

#### Safety Precautions

If you are using this instrument for the first time, make sure to thoroughly read the “Safety Precautions” given on pages v to vi.

#### Do not remove the cover from the instrument

Some sections inside the instrument have high voltages that are extremely dangerous. For internal inspection or adjustment, contact your nearest YOKOGAWA dealer.

#### Abnormal Symptoms

Never continue to use the instrument if there are any symptoms of trouble such as strange smells or smoke coming from the instrument. In such cases, immediately turn OFF the power and unplug the power cord. Also, turn OFF all devices under measurement that are connected to the input terminals. Then, contact your nearest YOKOGAWA dealer.

#### Power cord

Nothing should be placed on top of the power cord. The power cord should also be kept away from any heat sources. When unplugging the power cord from the outlet, never pull the cord itself. Always hold the plug and pull it. If the power cord is damaged, contact your dealer for replacement. Refer to page ii for the part number when placing an order.

### General Handling Precautions

#### Never place anything on top of the instrument.

Never place another instrument or any objects containing water on top of the instrument. This may cause problems.

#### Keep electrically charged objects away from the instrument.

Keep electrically charged objects away from the input terminals. They may damage the internal circuits.

#### Do not damage the LCD

The LCD is very vulnerable to scratches. Therefore, be careful not to damage the surface with sharp objects. Also, do not apply vibration or shock to it.

#### When not using the instrument for a long time

When the instrument is not being used for an extended period of time, unplug the power cord from the outlet.

#### When moving the instrument

First, turn OFF the devices under measurement and remove the measurement cables. Then, turn OFF the instrument and remove power and other cables. To carry the instrument, use the handle or carry it using both hands.

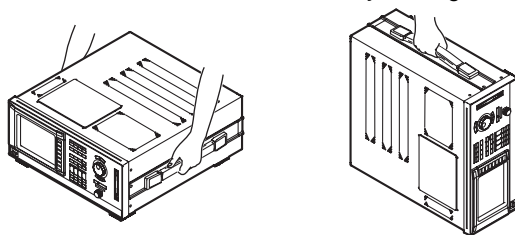

#### Cleaning

When cleaning the case or the operation panel, first turn OFF the circuit under measurement and the instrument and remove the instrument's power cord from the outlet. Then, wipe with a dry, soft cloth. Do not use volatile chemicals since this might cause discoloring and deformation.

---

## 3.2 Installing the Instrument

### Installation Conditions

Install the instrument in a place that meets the following conditions.

#### **Flat, even surface**

If the instrument is not installed on a stable horizontal surface, the printer's recording quality may degrade and precise measurements may be impeded.

#### **Well-ventilated location**

Vent holes are located on the top and bottom of the instrument. In addition, vent holes for the cooling fan are located on the top. To prevent internal overheating, allow at least 20 mm of space around the vent holes.

When connecting measurement wires and other various cables or when opening or closing the built-in printer cover, allow extra space for operation.

#### **Ambient temperature and humidity**

Ambient temperature : 5 to 40°C

Ambient humidity : 20 to 85%RH (when the printer is not used)

35 to 80%RH (when the printer is used)

No condensation in either case.

#### **Do not install the instrument in the following places :**

- In direct sunlight or near heat sources.
- Where an excessive amount of soot, steam, dust, or corrosive gases are present.
- Near strong magnetic field sources.
- Near high voltage equipment or power lines.
- Where the level of mechanical vibration is high.
- In an unstable place.

#### **Note**

- For the most accurate measurements, use the instrument in the following environment.  
Ambient temperature : 23±3°C Ambient humidity : 50±10%RH (no condensation)  
When using the instrument in a place where the ambient temperature is 5 to 20°C or 26 to 40°C, add the temperature coefficient to the accuracy of the module as specified in chapter 17.
  - When installing the instrument in a place where the ambient humidity is 30% or below, take measures to prevent static electricity such as using an anti-static mat.
  - Internal condensation may occur if the instrument is moved to another place where both the ambient temperature and humidity are higher, or if the temperature changes rapidly. In this case, let the instrument adjust to the new environment for at least one hour before using the instrument.
- 

### Storage Location

When storing the instrument, avoid the following places:

- Where the relative humidity is 80% or more.
- In direct sunlight.
- Where the temperature is 60°C or higher.
- Near heat sources.
- Where the level of mechanical vibration is high.
- Where corrosive or explosive gas is present.
- Where an excessive amount of soot, dust, salt, and iron are present.
- Where water, oil, or chemicals may splash.

It is recommended that the instrument be stored in an environment where the temperature is between 5 and 40°C and the relative humidity is between 20 and 80%.

## Installation position

### Desktop

Place the instrument on a flat, even surface as shown in the figure below. If the instrument is installed in a horizontal position, rubber feet can be attached to prevent slipping. Two sets (four pieces) of rubber feet are included in the package.

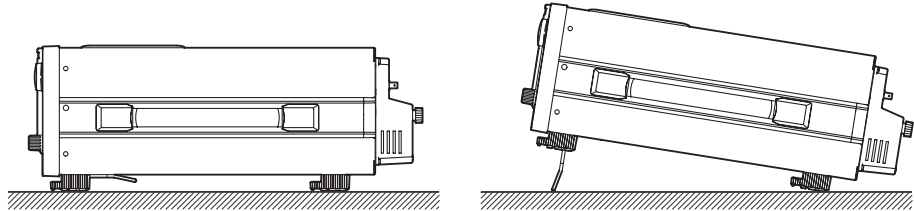

### Rack mount

To rack mount the instrument, use the rack mount kit that is sold separately.

Name	Model	Notes
Rack mount kit	751535-E4	For EIA
Rack mount kit	751535-J4	For JIS

An outline of the attachment procedures is given below. For details regarding the attachment procedures, see the instructions that are included with the rack mount kit.

1. Remove the handle on each side of the instrument.
2. Remove the four feet on the bottom of the instrument.
3. Remove the plastic revet and the four seals covering the rack mount attachment holes on both sides of the instrument near the front.
4. Places seals over the feet and handle attachment holes.
5. Attach the rack mount kit.
6. Mount the instrument on the rack.

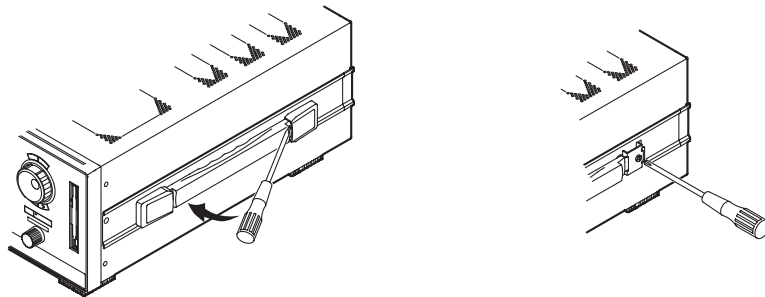

### Note

- When rack mounting the instrument, allow at least 20 mm of space around the vent holes to prevent internal overheating.
- Make sure to have adequate support for the bottom of the instrument. However, do not block the vent holes in the process.

## 3.3 Installing the Input Module



### WARNING

- To prevent shock and damage to the instrument when installing or removing input modules, turn OFF the power supply of the circuit under measurement, turn OFF the power switch of the instrument, and remove all measurement cables from all input modules.
- To prevent shock, degradation of the measurement accuracy due to internal heating, and electromagnetic interference, attach cover plates on the slots that do not have input modules installed.
- If the input module comes out of the slot while the instrument is in use, it can cause electric shock or damage the instrument and input module. Tighten the screws (four locations, top and bottom) that came with the input module to secure the module in place.
- Do not put your hand inside the slot, because there are protrusions along the module guide that may injure your fingers.

### Types of Input Modules

The following types of input modules are available.

MODEL	Name (Abbreviation)	Notes
253751	Power measurement module	Voltage 1000 V / current 5 A / current sensor 500 mV
253752	Power measurement module	Voltage 1000 V / current 5 A & 20 A / current sensor 500 mV
253771	Sensor input module	Motor module, 2 channel input. Input signals from revolution sensor or torque meter.

### Precautions when Installing or Removing Input Modules

- Install the power measurement modules in numerical order starting from the slot of element 1. If you skip elements that have a smaller number, measurements that use one of the available wiring methods may not be made properly (see section 5.2, “Selecting the Wiring Method”). (For example, do not install a power measurement module in element 2 and leave element 1 empty. Do not install power measurement modules in elements 1 and 3 and leave element 2 empty.)
- Install the sensor input module into the element number 4 slot. It will not operate properly if it is installed into another slot. When the sensor input module is installed, only three power measurement modules can be installed.
- If you replace an input module, the setup parameters of that element are initialized when the power is turned ON. To keep the previous settings, the setup parameters must be saved. For information on saving the setup parameters, see 12.5 “Saving and Loading Setup Parameters.”

## Installation Procedure

1. Check that no measurement cables are connected to any of the input modules.
2. Check that the power switch is turned OFF on the instrument.
3. After checking the element number that is indicated on the top section of the slot on the rear side of the instrument in which the input module is to be installed, install the input module along the guide. While holding the grip on the top and bottom of the input module, press the input module firmly into the slot until it clicks. If there is a cover plate on the slot, remove the cover plate first, then install the input module.
4. Tighten the screws (four locations, top and bottom) that came with the input module to secure the module in place.
5. Turn ON the instrument.
6. In the information screen, check to see that the correct model name for the input module is displayed at the element number in which the input module was installed. If it is not correct, remove the module according to the "Removal Procedure" described below, and re-install the module according to the above steps 1 to 5. For details regarding the information screen, see section 16.4, "Checking the System Condition."
7. After connecting the measurement cable according to sections 3.4 to 3.10 or 15.1, attach the current input protective cover using the four screws provided (M3 × 5).

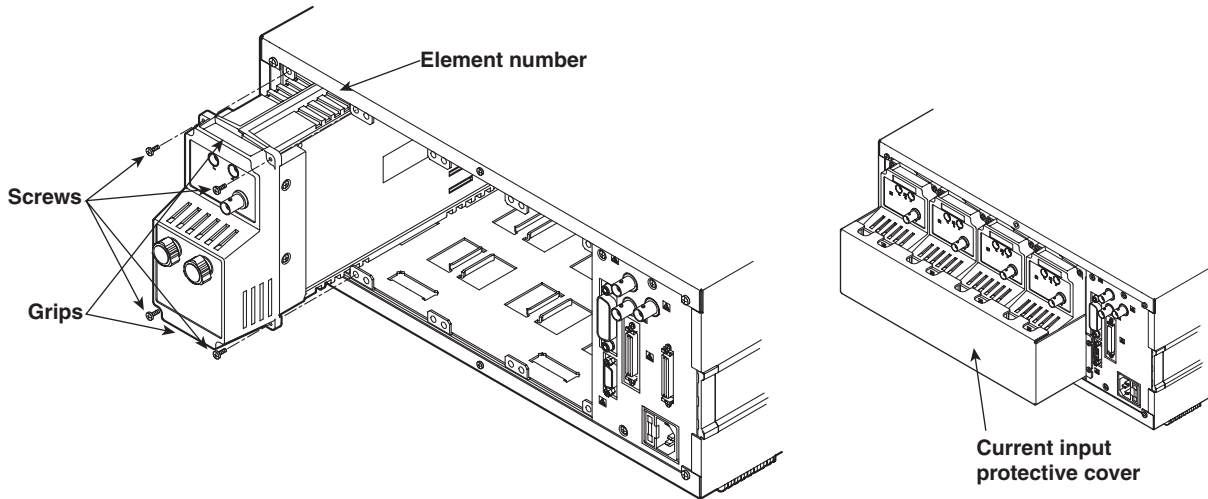

Information		Misc
Model: P24000		Information
Version: 1.00		GPiB/RS232
**** Module Configuration ****		SCSI ID
Element1:	Model: 253752(200 Shunt) 99/02/25 11:52:00 OK	Date/Time
Element2:	253752(200 Shunt) 99/02/25 11:52:00 OK	Config
Element3:	253752(200 Shunt) 99/02/25 11:52:00 OK	Selftest
Element4:	253752(200 Shunt) 99/02/25 11:52:00 OK	Next
***** Options *****		1/2
ACQ Memory: 4HWord/CH		
Printer: Yes		
SCSI: No		
Link Date: 99/02/25 Thu 11:39		

## Removal Procedure

1. Check that the power on the measurement circuit is turned OFF and remove the current input protective cover.
2. Remove all measurement cables from the input modules.
3. Check that the power switch is turned OFF on the instrument.
4. Loosen the four screws that secure the input module.
5. Hold the grip on the top and bottom of the module and pull the module out of the slot.
6. Attach a cover plate onto the slot.

---

## 3.4 Wiring Precautions

To prevent electric shock and damage to the instrument, follow the precautions below.



---

### WARNING

- Employ protective earth ground before connecting measurement cables.
- When wiring the circuit under measurement, turn OFF its power. Wiring or removing the cables without turning OFF the power is dangerous.
- Take special caution not to wire a current circuit to the voltage input terminal or a voltage circuit to the current input terminal.
- Strip the insulation cover of the measurement cable so that when it is wired to the input terminal, the conductive parts (bare wires) do not protrude from the terminal. Also, make sure to fasten the input terminal screws securely so that the cable does not come loose.
- Use cables with safety terminals that cover the conductive parts for connecting to the voltage input terminals. Using a terminal with bare conductive parts (such as a banana plug) is dangerous when the terminal comes loose.
- Use cables with safety terminals that cover the conductive parts for connecting to the current sensor input terminals. Using a terminal with bare conductive parts is dangerous when the terminal comes loose.
- Some input modules have multiple systems of current input terminals. Note that only one system (one set of current input terminals) can be used on a module at any given time. Remove all other cables connected to the current input terminals or current sensor input connector.
- When the voltage of the circuit under measurement is being applied to the current input terminals, do not touch the other current input terminals or current sensor terminals. Since these terminals are electrically connected inside the instrument, this act is dangerous.
- When connecting measurement cables from an external current sensor to the current sensor input connector, remove the cables connected to the current input terminals. In addition, when the voltage of the circuit under measurement is being applied to the current sensor input terminal, do not touch the other current input terminals or current sensor terminals. Since these terminals are electrically connected inside the instrument, this act is dangerous.
- When using the external potential transformer (PT) or current transformer (CT), make sure it has enough withstand voltage with respect to the voltage (U) being measured ( $2U + 1000$  V recommended). Also, make sure that the secondary side of the CT does not become an open circuit while the power is being applied. Otherwise, high voltage will appear at the secondary side of the CT, making it extremely dangerous.
- When using an external current sensor, make sure to use a sensor that comes in a case. The conductive parts and the case should be insulated, and the sensor should have enough withstand voltage with respect to the voltage being measured. Using a bare sensor is dangerous, because you might accidentally come in contact with it.
- When using a shunt-type current sensor as an external current sensor, turn OFF the circuit under measurement. If power is being applied, the voltage of the circuit under measurement will be applied to the shunt-type current sensor, making it dangerous.



- When using a clamp-type current sensor as an external current sensor, have a good understanding of the voltage of the circuit under measurement and the specifications and handling of the clamp-type sensor. Then, confirm that there are no shock hazards.
- For safety reasons, when using the instrument on a rack mount, furnish a switch for turning OFF the circuit under measurement from the front side of the rack.
- To make the protective functions effective, check the following items before applying the voltage or current of the circuit under measurement.
  - The power cable provided with the instrument is used to connect to the power supply and the instrument is grounded.
  - The power switch of the instrument is turned ON.
  - The current input protective cover provided with the instrument is being used.
- When the power switch of the instrument is turned ON, do not apply a signal that exceeds the following values to the voltage or current input terminals. When the instrument is turned OFF, turn OFF the circuit under measurement. For other input terminals, see the specifications of each module in chapter 17.

Max. Allowable Input	Voltage Input	Current Input
Instantaneous max. (1 second)	The peak value is 2000 V or the RMS value is 1000 V, whichever is less. (CAT II)	5 A terminal : The peak value is 30 A or the RMS value is 15 A, whichever is less. 20 A terminal : The peak value is 150 A or the RMS value is 40 A, whichever is less.
Continuous max.	Same as the "Instantaneous max." shown above.	5 A terminal : The peak value is 10 A or the RMS value is 7 A, whichever is less. 20 A terminal : The peak value is 100 A or the RMS value is 30 A, whichever is less.



### CAUTION

Use measurement cables that have adequate margins of withstand voltage and current capacity with respect to the voltage or current being measured. It should also have proper ratings that are suited to the measurement.

Example : When making measurements on a current of 20 A, use copper wires that have a conductive cross-sectional area of 4 mm<sup>2</sup>.

### Note

- After wiring, the wiring method must be selected. See section 5.2, "Selecting the Wiring Method."
- When measuring large currents or voltages or currents that contain high frequency components, take special care in dealing with mutual interference and noise when wiring.
- Keep the measurement cables as short as possible to minimize the loss between the circuit under measurement and the instrument.
- The thick lines on the wiring diagrams shown in sections 3.7 and 3.10 are the sections where the current flows. Use appropriate wires that are suitable for the current.
- In order to make accurate measurements of the voltage of the circuit under measurement, connect the cable to the circuit as close as possible.
- In order to make correct measurements, separate the measurement cables as far away from the earth ground wires and the instrument's case as possible to minimize the static capacitance to earth ground.

## 3.5 For Making Accurate Measurements

### Effects of Power Loss

By using an appropriate wiring method that matches the load, the effects of power loss on measurement accuracy can be minimized.

We will consider the current source (SOURCE) and load resistance (LOAD) below.

#### When the measured current is relatively large

Wire so that the voltage measurement circuit is connected to the load side. The current measurement circuit measures the sum of current  $i_L$  flowing through the load of the circuit under measurement and the current  $i_V$  flowing through the voltage measurement circuit. Because the current flowing through the circuit under measurement is  $i_L$ ,  $i_V$  is the amount of error. The input resistance of the voltage measurement circuit of the instrument is approximately  $1\text{ M}\Omega$ . If the input is  $1000\text{ V}$ ,  $i_V$  is approximately  $1\text{ mA}$  ( $1000\text{ V}/1\text{ M}\Omega$ ). If the load current,  $i_L$ , is  $10\text{ A}$  or more (load resistance is  $100\ \Omega$  or less), then the effect of  $i_V$  on the measurement is  $0.01\%$  or less. If the input is  $100\text{ V}$  and  $10\text{ A}$ ,  $i_V = 0.1\text{ mA}$  ( $100\text{ V}/1\text{ M}\Omega$ ) then the effect of  $i_V$  on the measurement accuracy is  $0.001\%$  ( $0.1\text{ mA}/10\text{ A}$ ).

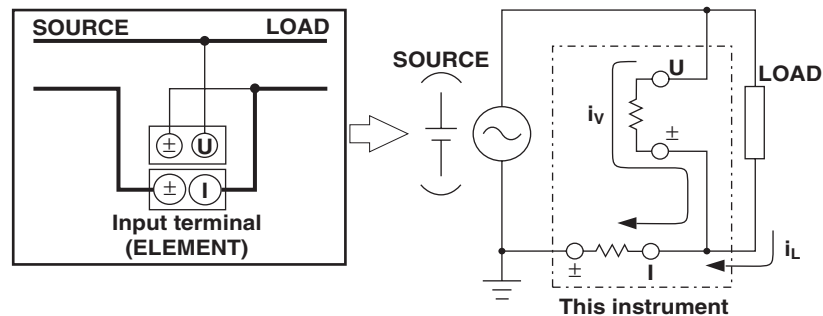

As a reference, the relationship of the voltages and currents that produce effects of  $0.1\%$ ,  $0.01\%$ , and  $0.001\%$  are shown in the figure below.

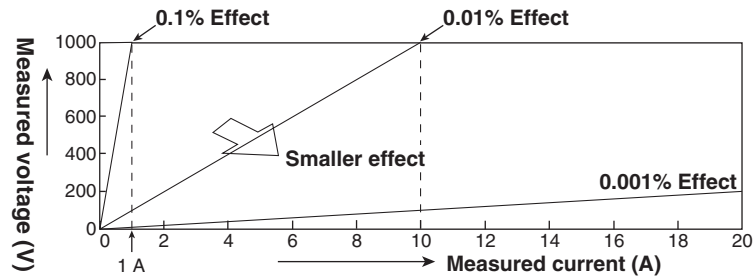

#### When the measured current is relatively small

Wire so that the current measurement circuit is connected to the load side. In this case, the voltage measurement circuit measures the sum of the load voltage  $e_L$  and voltage drop  $e_I$  across the current measurement circuit.  $e_I$  is the amount of error in this case. The input resistance of the current measurement circuit of the instrument is  $100\text{ m}\Omega$  and  $11\text{ m}\Omega$  for the  $5\text{-A}$  and  $20\text{-A}$  terminals, respectively. For example, if the load resistance is  $1\text{ k}\Omega$ , then the effects on the measurement accuracy is  $0.01\%$  for the  $5\text{-A}$  terminal ( $100\text{ m}\Omega/1\text{ k}\Omega$ ) and  $0.0011\%$  for the  $20\text{-A}$  terminal ( $11\text{ m}\Omega/1\text{ k}\Omega$ ).

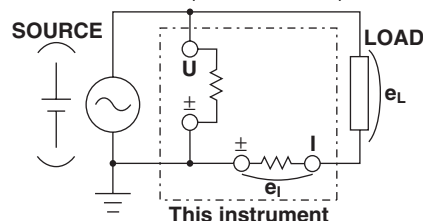

**Effects of Stray Capacitance**

The effects of stray capacitance on the measurement accuracy can be minimized by connecting the current input terminal of the instrument to the side that is close to the earth potential of the power source (SOURCE)

The internal structure of the instrument is as follows. The voltage and current measurement circuits are each enclosed in shielded cases. These shielded cases are placed inside the outer case. The shielded case of the voltage measurement circuit is connected to the ± terminal of the voltage input terminal and the shielded case of the current measurement circuit is connected to the ± terminal of the current input terminal.

Because the outer case is insulated from the shielded case, stray capacitance  $C_s$  of approximately 100 pF exists. The current generated by this stray capacitance,  $C_s$ , will cause errors.

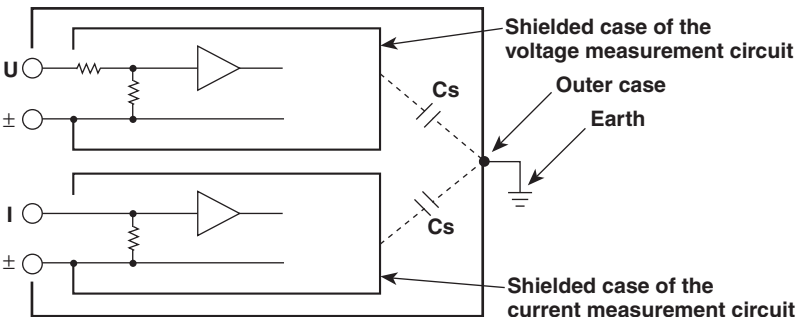

For example, we will consider the case when one side of the power source and the outer case are grounded.

In this case, two current flows can be considered, load current  $i_L$  and the current that flows through the stray capacitance  $i_{Cs}$ .  $i_L$  flows through the current measurement circuit, then through the load, and returns to the power source (shown with a dotted line).  $i_{Cs}$  flows through the current measurement source, through the stray capacitance, and then through the earth ground of the outer case, and returns to the power source (shown with a dot-dash line).

Therefore, the current measurement circuit ends up measuring the sum of  $i_L$  and  $i_{Cs}$  even though it wants to measure only  $i_L$ .  $i_{Cs}$  is the amount of error in this case. If the voltage applied to  $C_s$  is  $V_{Cs}$  (common mode voltage), then  $i_{Cs}$  can be found using the following equation. Because the phase of  $i_{Cs}$  is ahead of the voltage by  $90^\circ$  the effects of  $i_{Cs}$  on the measurement accuracy increases as the power factor gets smaller.

$$i_{Cs} = V_{Cs} \times 2\pi f \times C_s$$

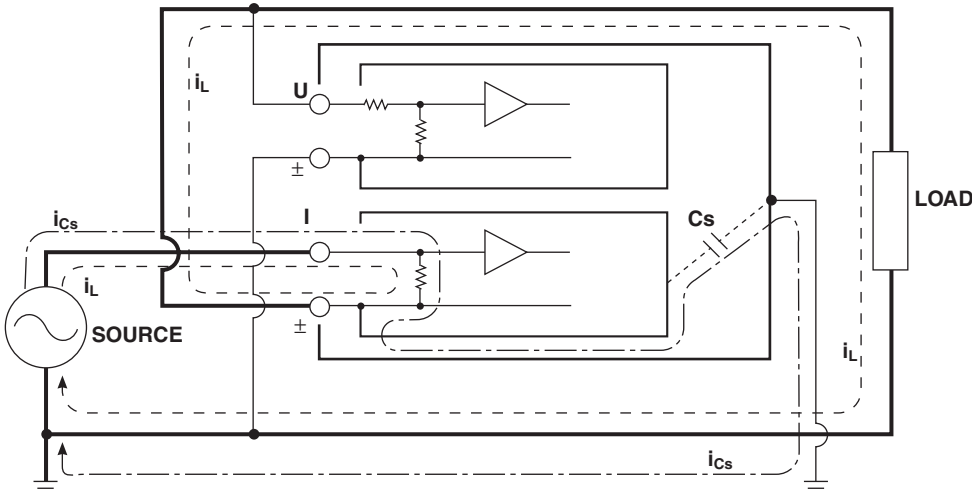

When measuring high frequencies as in this instrument, this error,  $i_{Cs}$ , cannot be ignored. By connecting the current input terminal of the instrument to the side that is close to the earth potential of the power source (SOURCE), the ± terminal of the current measurement circuit of the instrument approaches the earth potential. Thus,  $V_{Cs}$  becomes approximately zero and very little  $i_{Cs}$  flows. As a result, the effect on the measurement accuracy is minimized.

## 3.6 Connecting the Power Supply

### Before connecting the power

Follow the warnings below to avoid electric shock and damage to the instrument.



### WARNING

- Connect the power cord only after confirming that the voltage of the power supply matches the rated electric power voltage for the instrument.
- Connect the power cord after checking that the power switch of the instrument is turned OFF.
- To prevent electric shock or fire, always use the power cord supplied by YOKOGAWA.
- Always use protective earth to prevent electric shock. Connect the power cord of the instrument to a three-pole power outlet that has a protective earth terminal.
- Never use an extension cord that does not have protective earth, otherwise the protection function will be compromised.

### Connecting Procedure

1. Check that the power switch is OFF.
2. Connect the plug of the accessory power cord to the power connector on the rear panel of the instrument.
3. Plug the other end of the power cord into a power outlet that satisfies the conditions below. The AC outlet must be a three-pole type that has a protective earth terminal.

Item	Specification
Rated supply voltage	: 100 to 120 VAC, 200 to 240 VAC
Permitted supply voltage range	: 90 to 132 VAC, 180 to 264 VAC
Rated supply voltage frequency	: 50/60 Hz
Permitted supply voltage frequency range	: 48 to 63 Hz
Maximum power consumption (when using the printer)	: 200 VA

On some instruments,  
the direction of the power  
connector may be as shown below.

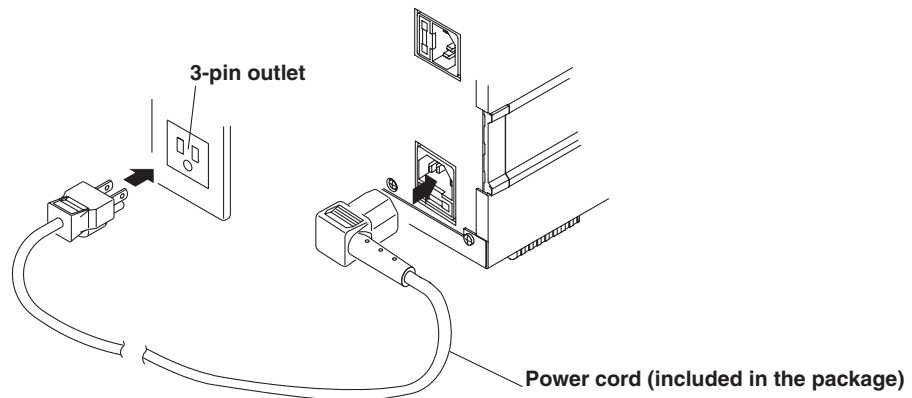

---

## 3.7 Directly Wiring the Circuit under Measurement

The measurement cable is wired directly from the circuit under measurement to the voltage/current input terminal of the power measurement module.

To prevent electric shock and damage to the instrument follow the precautions given in section 3.4, "Wiring Precautions."

### Connecting to the Input Terminal

#### Voltage input terminal

Insert the safety terminal (the conductive parts are not exposed) into the voltage input terminal

#### Current input terminal

Power module 253751 has 5-A terminals.

Power module 253752 has two types of terminals, 5-A and 20-A terminals, but only one system of current input (one set of current input terminals) can be used on each input module at one time. To prevent electric shock and damage to the instrument, do not wire measurement cables to multiple current input terminals simultaneously.

The screws used on the terminal (binding post) are M6 screws. Either wind the wire around the screw or pass the crimp-on lugs through the screw axis, then tighten firmly by holding the terminal knob.

### 3.7 Directly Wiring the Circuit under Measurement

#### Combinations of Wiring Methods and Elements

The combination of the selectable wiring methods and elements varies depending on the installation position of the power measurement modules as follows.

Elements that has power measurement modules installed	Selectable wiring methods	Combination of elements
Only 1	1P2W	1
1 and 2	1P2W-1P2W 1P3W 3P3W	1-2 (1 and 2) (1 and 2)
1, 2, and 3	1P2W-1P2W (All three elements are handled as single-phase, two-wire systems.) 1P2W-1P3W 1P2W-3P3W 1P3W-1P2W 3P3W-1P2W 3V3A 3P4W	1-2-3 1-(2 and 3) 1-(2 and 3) (1 and 2)-3 (1 and 2)-3 (1, 2, and 3) (1, 2, and 3)
1, 2, 3, 4	1P2W-1P2W (All four elements are handled as single-phase, two-wire systems.) 1P2W-1P3W (Elements 1 and 4 are handled as single-phase, two-wire systems.) 1P2W-3P3W (Elements 1 and 4 are handled as single-phase, two-wire systems.) 1P2W-3V3A 1P2W-3P4W 1P3W-1P2W (Elements 3 and 4 are handled as single-phase, two-wire systems.) 1P3W-1P3W 1P3W-3P3W 3P3W-1P2W (Elements 3 and 4 are handled as single-phase, two-wire systems.) 3P3W-1P3W 3P3W-3P3W 3V3A-1P2W 3P4W-1P2W	1-2-3-4 1-(2 and 3)-4 1-(2 and 3)-4 1-(2 and 3)-4 1-(2, 3, and 4) 1-(2, 3, and 4) (1 and 2)-3-4 (1 and 2)-(3 and 4) (1 and 2)-(3 and 4) (1 and 2)-3-4 (1 and 2)-(3 and 4) (1 and 2)-(3 and 4) (1, 2, and 3)-4 (1, 2, and 3)-4

- 1P2W : single-phase, two-wire system
- 1P3W : single-phase, three-wire system
- 3P3W : three-phase, three-wire system
- 3V3A : three-voltage, three-current system
- 3P4W : three-phase, four-wire system

**Note**

- Check that the power measurement modules are installed in order starting from the element number 1 slot. If you leave the slots that have smaller element numbers empty, measurements will not be made properly. (For example, do not install a power measurement module into the element number 2 slot and leave the element number 1 slot empty. Do not install power measurement modules into element number 1 and 3 slots and leave the element number 2 slot empty.) For the procedures on installing the modules, see section 3.3, "Installing the Input Module."
- When the sensor input module is installed into the element number 4 slot, only up to three power measurement modules can be installed. In this case, you cannot select a wiring method that uses four power measurement modules.
- After wiring, the wiring method must be selected. See section 5.2, "Selecting the Wiring Method."
- The thick lines on the wiring diagrams are the sections where the current flows. Use appropriate wires that are suitable for the current.

**Wiring Example of a single-phase, two-wire system (1P2W)**

If power measurement modules are installed into all four slots, four single-phase two-wire systems can be set up.

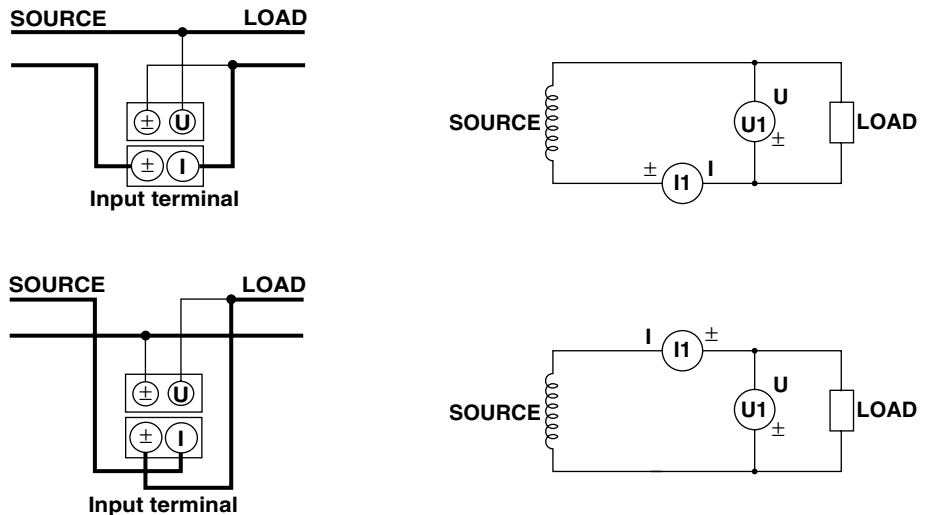

**Wiring Example of a single-phase, three-wire system (1P3W)**

- If power measurement modules are installed in all four slots, then two single-phase three-wire systems can be set up (elements 1 and 2 and elements 3 and 4).
- The combination of elements that can be wired to the input terminals in the figure are as follows. The rest of the elements can be wired to single-phase, two-wire systems.

Input Terminal 1	Input Terminal 2
Element 1	Element 2
Element 2	Element 3
Element 3	Element 4

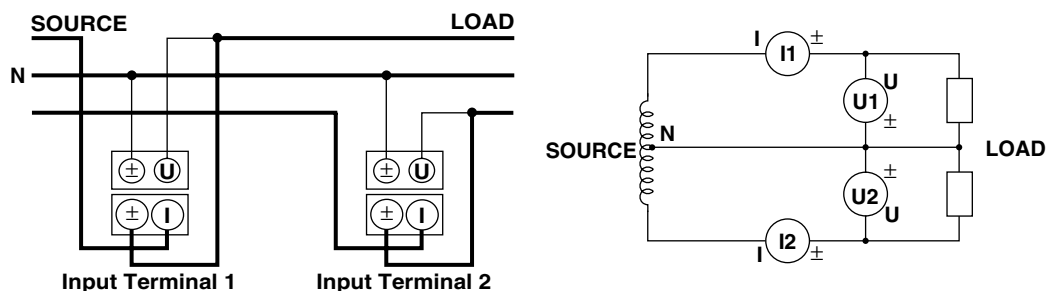

### 3.7 Directly Wiring the Circuit under Measurement

#### Wiring Example of a three-phase, three-wire system (3P3W)

- If power measurement modules are installed in all four slots, then two three-phase three-wire systems can be set up (elements 1 and 2 and elements 3 and 4).
- The combination of elements that can be wired to the input terminals in the figure are as follows. The rest of the elements can be wired to single-phase, two-wire systems.

Input Terminal 1	Input Terminal 2
Element 1	Element 2
Element 2	Element 3
Element 3	Element 4

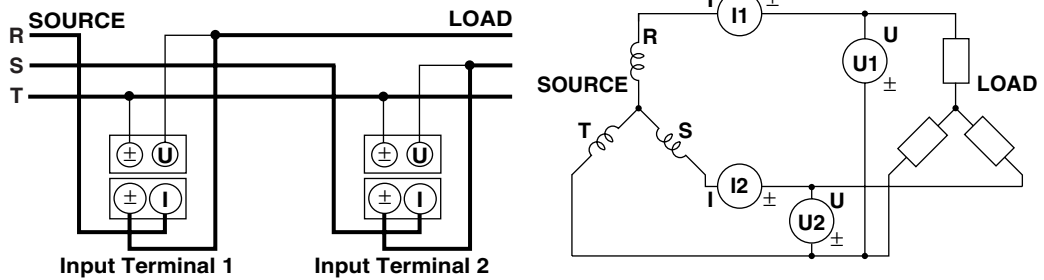

#### Wiring Example of a three-voltage, three-current system (3V3A)

The combination of elements that can be wired to the input terminals in the figure are as follows. The rest of the elements can be wired to single-phase, two-wire systems.

Input Terminal 1	Input Terminal 2	Input Terminal 3
Element 1	Element 2	Element 3
Element 2	Element 3	Element 4

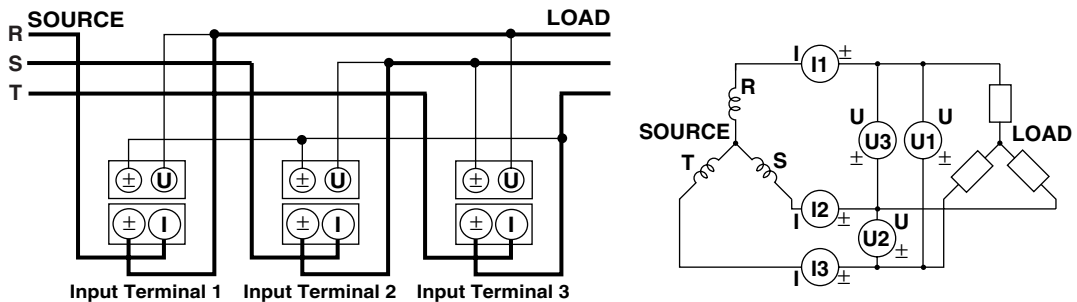

#### Wiring Example of a three-phase, four-wire system (3P4W)

The combination of elements that can be wired to the input terminals in the figure are as follows. The rest of the elements can be wired to single-phase, two-wire systems.

Input Terminal 1	Input Terminal 2	Input Terminal 3
Element 1	Element 2	Element 3
Element 2	Element 3	Element 4

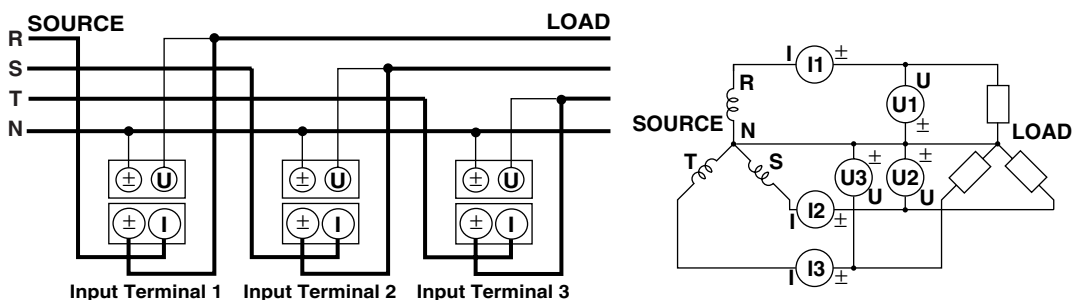



## 3.8 Using an External Current Sensor to Wire the Circuit under Measurement

To prevent electric shock and damage to the instrument follow the precautions given in section 3.4, "Wiring Precautions."

- As shown below, when the maximum current value of the circuit under measurement exceeds the maximum measurement range of the current input terminal, an external sensor cable from the external current sensor can be connected to the current sensor input connector of the power measurement module in order to measure the current of the circuit under measurement.
  - Power measurement module 253751  
When the maximum current exceeds "7 Arms" or "10 Apeak."
  - Power measurement module 253752
    - 5-A terminal : When the maximum current exceeds "7 Arms" or "10 Apeak."
    - 20-A terminal : When the maximum current exceeds "30 Arms" or "100 Apeak."
- A shunt-type or clamp-type current sensor can be used for an external current sensor.

### Connecting to the current sensor input connector

Connect an external sensor cable, with the BNC connector that is included in the package, to the current sensor input connector of the power measurement module.

### Combination of Wiring Methods and Elements

The combination of the selectable wiring methods and elements varies depending on the number of installed power measurement modules. For details, see "Combination of Wiring Methods and Elements" and "Wiring Examples" in section 3.7, "Directly Wiring the Circuit under Measurement."

### 3.8 Using an External Current Sensor to Wire the Circuit under Measurement

**Note**

- Check that the power measurement modules are installed in order starting from the element number 1 slot. If you leave the slots that have smaller element numbers empty, measurements will not be made properly. (For example, do not install a power measurement module into the element number 2 slot and leave the element number 1 slot empty. Do not install power measurement modules into element number 1 and 3 slots and leave the element number 2 slot empty.) For the procedures on installing the modules, see section 3.3, “Installing the Input Module.”
- When the sensor input module is installed into the element number 4 slot, only up to three power measurement modules can be installed. In this case, you cannot select a wiring method that uses four power measurement modules.
- After wiring, the wiring method must be selected. See section 5.2, “Selecting the Wiring Method.”
- The thick lines on the wiring diagrams are the sections where the current flows. Use appropriate wires that are suitable for the current.
- The current sensor input transformation function can be used to transform the input signal to data that correspond to direct measurements. For the procedures, see section 5.4, “Setting the Measurement Range when using an External Current Sensor.”
- Note that the frequency and phase characteristics of the external current sensor affect the measured data.
- Make sure that the polarity is correct when connecting to the circuit. Otherwise, the polarity of the measured current is reversed and proper measurements cannot be made. Be especially careful when using a clamp-type current sensor, because it is easy to reverse the connection.
  - To minimize error when using a shunt-type sensor, note the following points when connecting the external sensor cable.
    - Connect the shielded wire of the external sensor cable to the L side of the shunt output terminal (OUT).
    - Minimize the area created between the wires connecting the current sensor to the external sensor cable. The effects due to the line of magnetic force and noise that enter this area of space can be reduced.

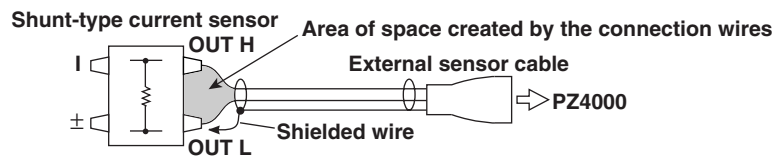

- For a shunt-type current sensor, connect it to the power earth ground side as shown in the figure below. If you have to connect the sensor to the non-earth side, use a wire that is thicker than AWG18 (conductive cross-sectional area of approx. 1 mm<sup>2</sup>) between the sensor and the instrument to reduce the effects of common mode voltage. Take safety and error reduction in consideration when constructing an external sensor cable.

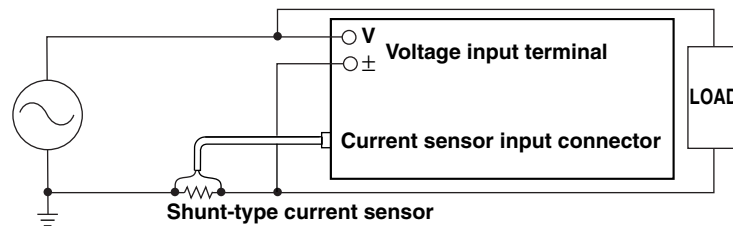

- When the circuit under measurement is not grounded and the signal is high in frequency or large in power, the effects of the inductance of the connection cable for the shunt-type current sensor become large. In these cases, use an isolation sensor (CT, DC-CT, or clamp) for the measurements.

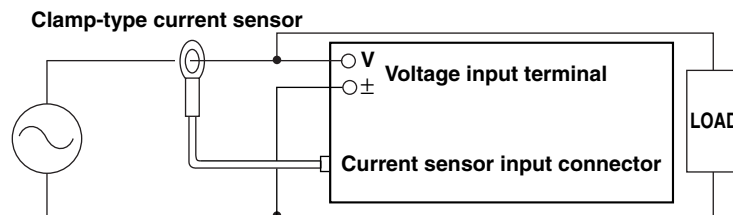

### 3.8 Using an External Current Sensor to Wire the Circuit under Measurement

The following wiring examples are for connecting shunt-type current sensors. When connecting a clamp-type current sensor, replace the shunt-type current sensor with the clamp-type. For the combinations of the elements and the input terminals in the figures below, see “Wiring Examples” in section 3.7, “Directly Wiring the Circuit under Measurement.”

#### Wiring Example of a single-phase, two-wire system (1P2W) using a shunt-type current sensor

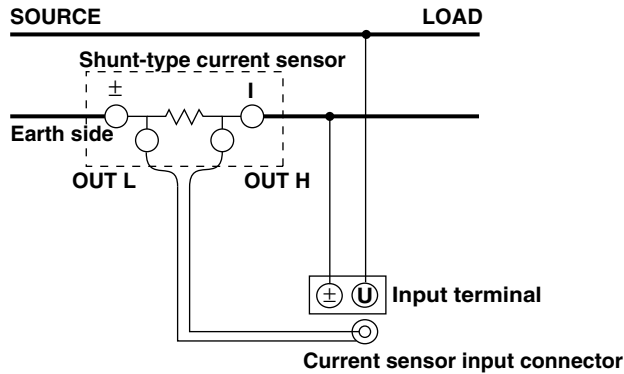

#### Wiring Example of a single-phase, three-wire system (1P3W) using a shunt-type current sensor

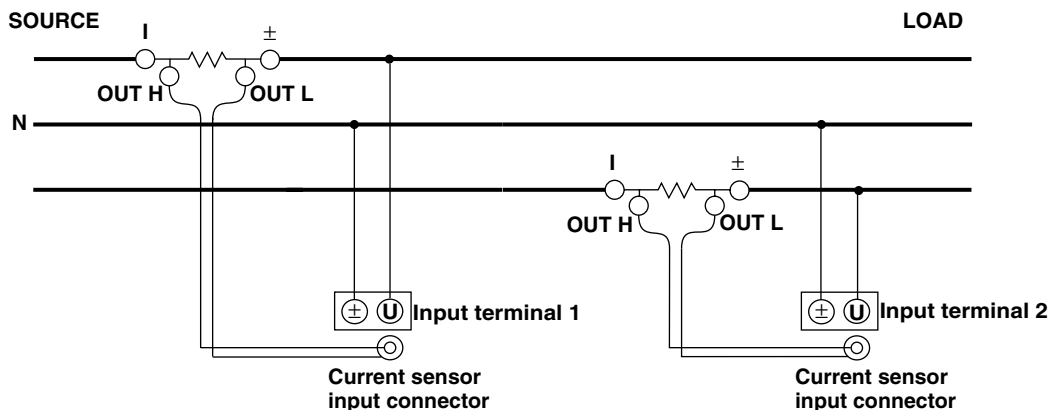

#### Wiring Example of a three-phase, three-wire system (3P3W) using a shunt-type current sensor

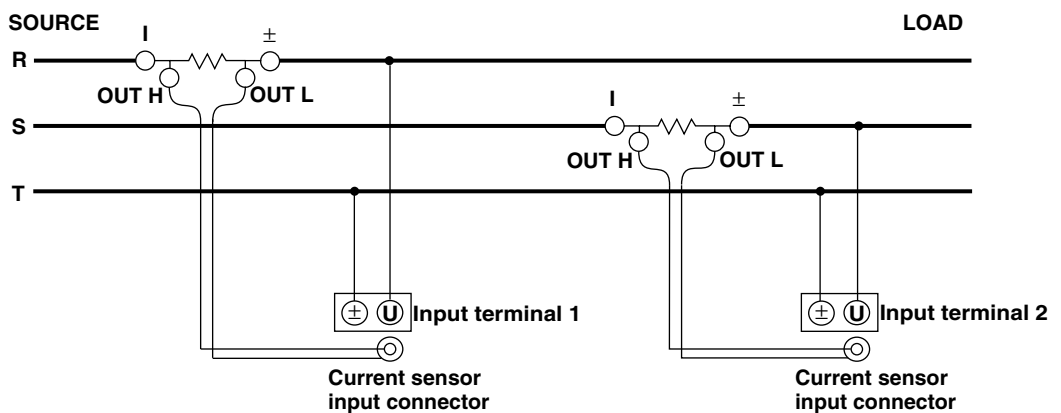

### 3.8 Using an External Current Sensor to Wire the Circuit under Measurement

#### Wiring Example of a three-voltage, three-current system (3V3A) using a shunt-type current sensor

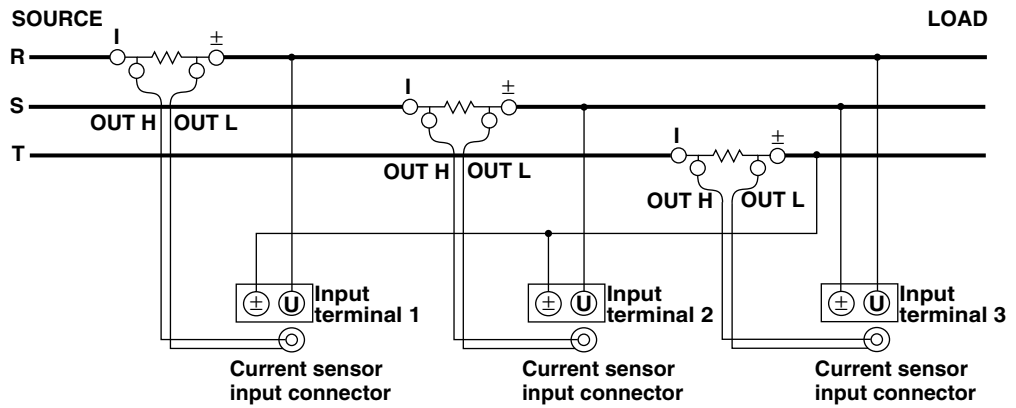

#### Wiring Example of a three-phase, four-wire system (3P4W) using a shunt-type current sensor

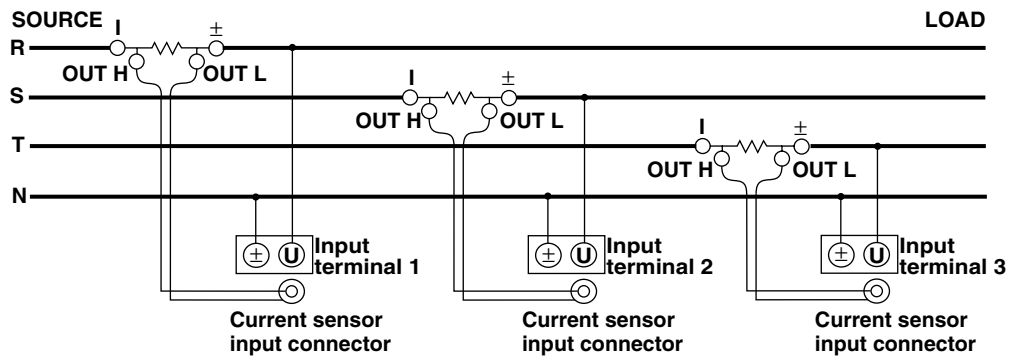

## 3.9 Using an External PT or CT to Wire the Circuit under Measurement

Connect a measurement cable from an external potential transformer (PT) or current transformer (CT) to the voltage or current input terminal of the power measurement module.

To prevent electric shock and damage to the instrument follow the precautions given in section 3.4, "Wiring Precautions."

- An external PT can be used to make measurements when the maximum voltage value of the circuit under measurement exceeds the maximum measurement range of the power measurement module, "1000 Vrms" or "2000 Vpeak."
- An external CT can be used to make measurements when the maximum current value of the circuit under measurement exceeds the maximum current range of the power measurement module.
  - Power measurement module 253751  
When the maximum current exceeds "7 Arms" or "10 Apeak."
  - Power measurement module 253752
    - 5-A terminal : When the maximum current exceeds "7 Arms" or "10 Apeak."
    - 20-A terminal : When the maximum current exceeds "30 Arms" or "100 Apeak."

### Connecting to the Input Terminal

#### Voltage input terminal

Insert the safety terminal (the conductive parts are not exposed) into the voltage input terminal

#### Current input terminal

The power measurement module 253751 has 5-A terminals.

Power measurement module 253752 has two types of terminals, 5-A and 20-A terminals, but only one system of current input (one set of current input terminals) can be used on each input module at one time. To prevent electric shock and damage to the instrument, do not wire measurement cables to multiple current input terminals simultaneously.

The screws used on the terminal (binding post) are M6 screws. Either wind the wire around the screw or pass the crimp-on lugs through the screw axis, then tighten firmly by holding the terminal knob.

### Combination of Wiring Methods and Elements

The combination of the selectable wiring methods and elements varies depending on the number of installed power measurement modules. For details, see "Combination of Wiring Methods and Elements" and "Wiring Examples" in section 3.7, "Directly Wiring the Circuit under Measurement."

### 3.9 Using an External PT or CT to Wire the Circuit under Measurement

#### Note

- Check that the power measurement modules are installed in order starting from the element number 1 slot. If you leave the slots that have smaller element numbers empty, measurements will not be made properly. (For example, do not install a power measurement module into the element number 2 slot and leave the element number 1 slot empty. Do not install power measurement modules into element number 1 and 3 slots and leave the element number 2 slot empty.) For the procedures on installing the modules, see section 3.3, “Installing the Input Module.”
- When the sensor input module is installed into the element number 4 slot, only up to three power measurement modules can be installed. In this case, you cannot select a wiring method that uses four power measurement modules.
- After wiring, the wiring method must be selected. See section 5.2, “Selecting the Wiring Method.”
- The thick lines on the wiring diagrams indicate areas of current flow. Use wires that are suitable for the current present.
- The scaling function can be used to transform the input signal to data that correspond to direct measurements. For the procedures, see section 5.5, “Setting the Scaling Function when using an External PT or CT.”
- Note that the frequency and phase characteristics of the PT or CT affect the measured data.

For the combinations of the elements and the input terminals in the figures below, see “Wiring Examples” in section 3.7, “Directly Wiring the Circuit under Measurement.”

#### Wiring Example of a single-phase, two-wire system (1P2W) using PT and CT

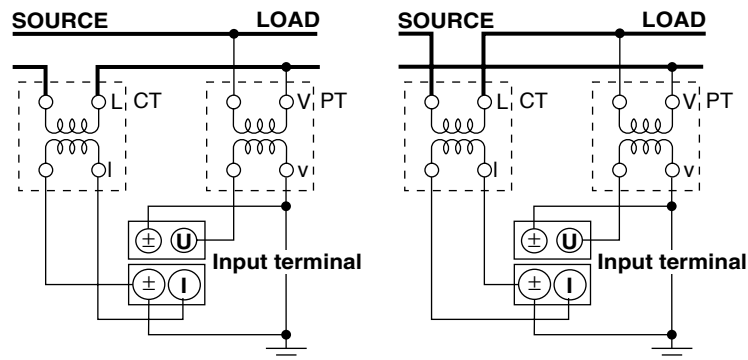

#### Wiring Example of a single-phase, three-wire system (1P3W) using PT and CT

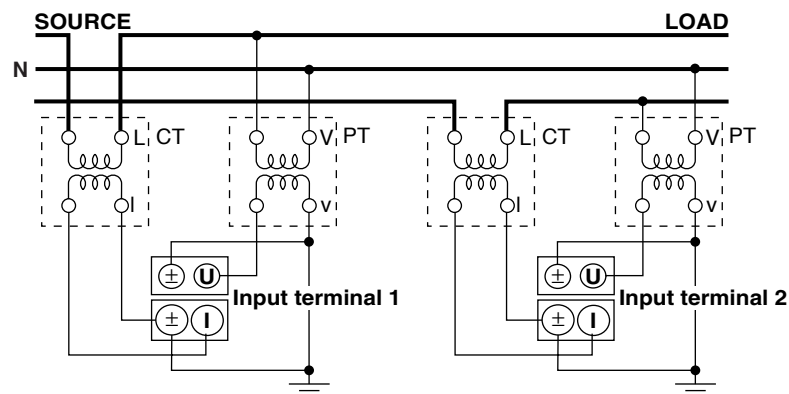

Wiring Example of a three-phase, three-wire system (3P3W) using PT and CT

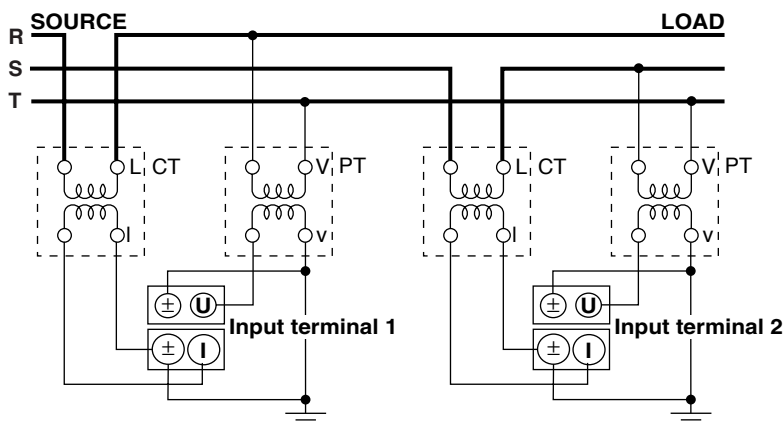

Wiring Example of a three-voltage, three-current system (3V3A) using PT and CT

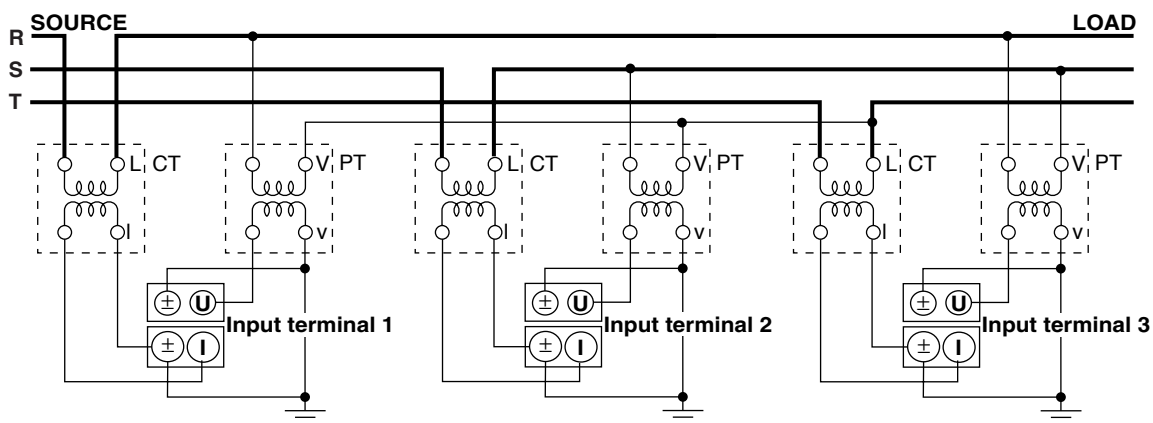

Wiring Example of a three-phase, four-wire system (3P4W) using PT and CT

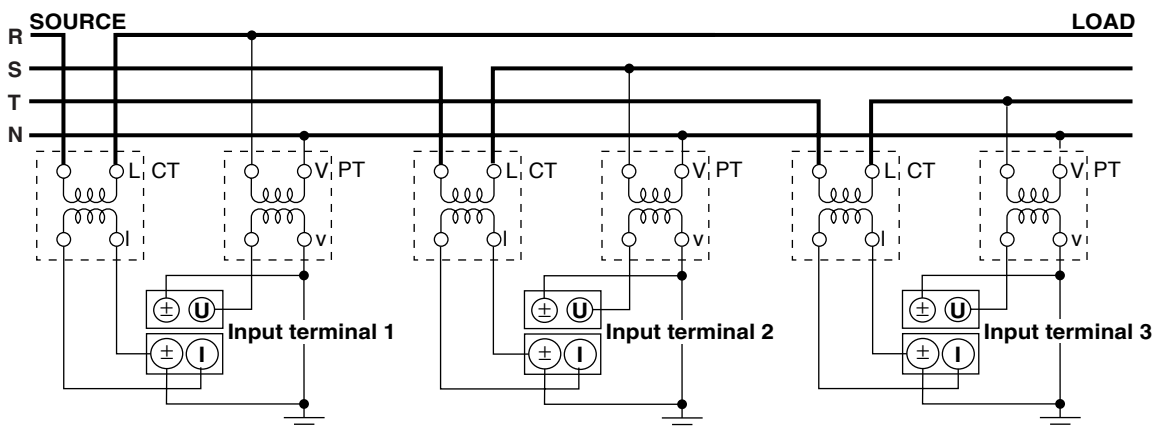

## 3.10 Wiring a Circuit with Voltage Input Exceeding 600 V

When the voltage across the voltage input terminals exceeds 600 V, do not directly input the current to the current input terminals. Connect the output of an isolation sensor (CT, DT-CT, or clamp) to the current sensor input connector.



### WARNING

- The rated voltage between the input terminal (voltage input terminal, current input terminal, and current sensor input connector) and earth ground is 600 V. Do not apply a voltage exceeding 600 V.
- The rated voltage between the voltage and current input terminals, between the voltage input terminal and current sensor input connector, and between the current input terminal and current sensor input connector is 600 V. Do not apply a voltage exceeding 600 V.
- The rated voltage between the U-voltage input terminal and the  $\pm$  terminal of voltage input terminal is 1000 V. Do not apply a voltage exceeding 1000 V.
- When the voltage across the voltage input terminals exceeds 600 V, do not directly input the current to the current input terminals. Connect the output of an isolation sensor (CT, DT-CT, or clamp) to the current sensor input connector.
- Follow the precautions given in section 3.4, "Wiring Precautions."

When the isolation sensor is current output

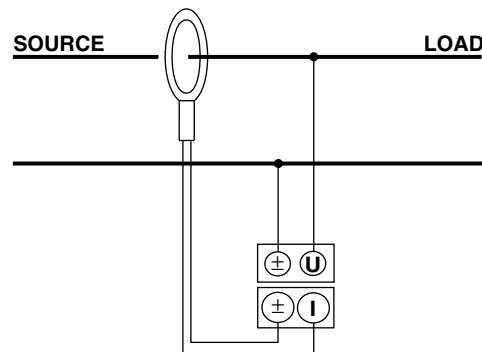

When the isolation sensor is voltage output

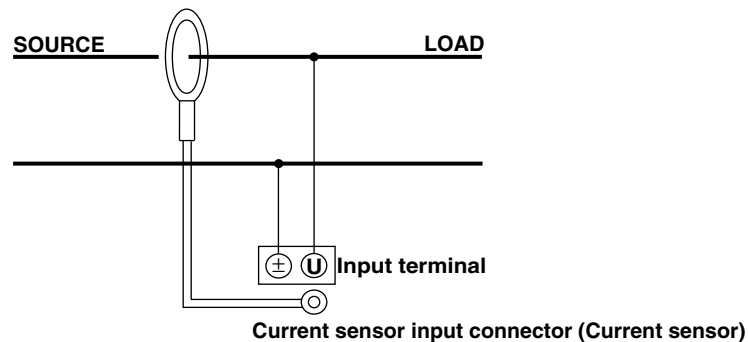

### Note

For wiring precautions, see also sections 3.8 and 3.9.



## 3.11 Turning ON/OFF the Power Switch

### Points to Check before Turning ON the Power

- Check that the instrument is installed properly (see section 3.2, “Installing the Instrument”).
- Check that the input module is installed properly (see section 3.3, “Installing the Input Module”).
- Check that the power cord is connected properly (see section 3.6, “Connecting the Power Supply”).
- Check that the circuit under measurement is wired properly (see sections 3.7 “Directly Wiring the Circuit under Measurement,” 3.8 “Using an External Current Sensor to Wire the Circuit under Measurement,” 3.9 “Using an External PT or CT to Wire the Circuit under Measurement,” and 3.10 “Wiring a Circuit with Voltage Input Exceeding 600 V.”)

### Location of the Power Switch

The power switch is located in the lower left corner of the front panel.

### Turning ON/OFF the Power Switch

Pressing the button once turns the instrument ON. Pressing it again turns the instrument OFF.

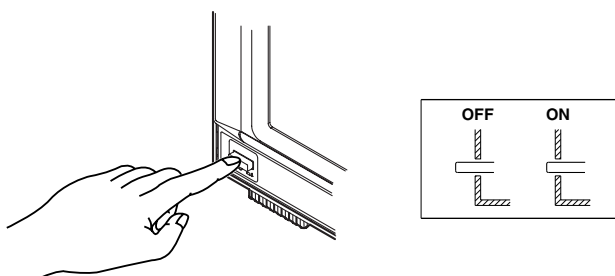

### The Order in Turning ON/OFF the Power

When using the model with the SCSI option and you wish to save or load data using an external SCSI device, turn ON the SCSI device first, then turn ON this instrument. When turning OFF the instrument and SCSI device, reverse the order.

### Power Up Operation

When the power switch is turned ON, the self-test starts automatically. When the self-test completes successfully, the display shows the screen that is displayed when the power switch is turned OFF.

#### Note

If the instrument does not operate as described above when the power switch is turned ON, turn OFF the power switch and check the following points.

- Check that the power cord is securely connected to the outlet.
- Check that the correct voltage is coming to the power outlet (see section 3.6, “Connecting the Power Supply.”)
- Check that the fuse is not blown (see section 16.5, “Replacing the Power Fuse”).
- If the power switch is turned ON while pressing the RESET key, the setting parameters are initialized to their factory default values. For information on initialization, see section 4.2, “Initializing the Settings.”

If the instrument still does not work after checking these points, contact your nearest YOKOGAWA dealer for repairs.

#### For Making Accurate Measurements

- Turn ON the power switch and allow the instrument to warm up for at least 30 minutes.
- Perform zero-level compensation after warm-up (see section 4.4, “Performing Zero-Level Compensation”).

#### Shut Down Operation

The setup parameters that exist immediately before the power switch is turned OFF are stored in memory. The same is true when the power cord gets disconnected from the outlet. The next time the power switch is turned ON, the instrument powers up using the stored setup parameters.

#### **Note**

---

A lithium battery is used to retain the setup parameters. When the lithium battery voltage falls below a certain level, a message is displayed on the screen (see section 16.2) when the power switch is turned ON. When this message appears frequently, the battery must be replaced quickly. The user cannot replace the battery. For battery replacement, contact your nearest YOKOGAWA dealer. For information regarding battery life, see section 16.6.

---

## 3.12 Setting the Date and Time

### Keys

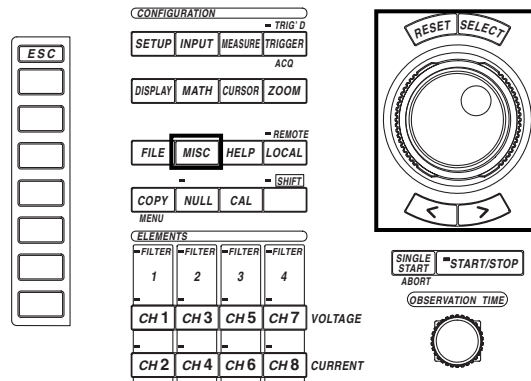

- The   mark indicates the keys that are used for the operation.
- To exit the menu during operation, press the ESC key.

### Procedures

1. Press the MISC key to display the Misc menu.
2. Press the [Date/Time] soft key to display the date/time setting dialog box.

#### Turning ON/OFF the date/time display

3. Turn the jog shuttle to select [Display].
4. Press the SELECT key to select [ON] or [OFF].

#### Setting the date or time

5. Turn the jog shuttle to select [Date] or [Time].
6. Press the SELECT key to display the keyboard.
7. Use the keyboard to set the date or time.

For keyboard operations, see section 4.1, "Entering Values and Strings."

#### Confirming the new settings

8. Turn the jog shuttle to select [Set].
9. Press the SELECT key. If [ON] was selected in step 4, the new date and time are displayed in the lower right corner of the screen. If the procedure is aborted without pressing the SELECT key, the new settings are not reflected on the display.

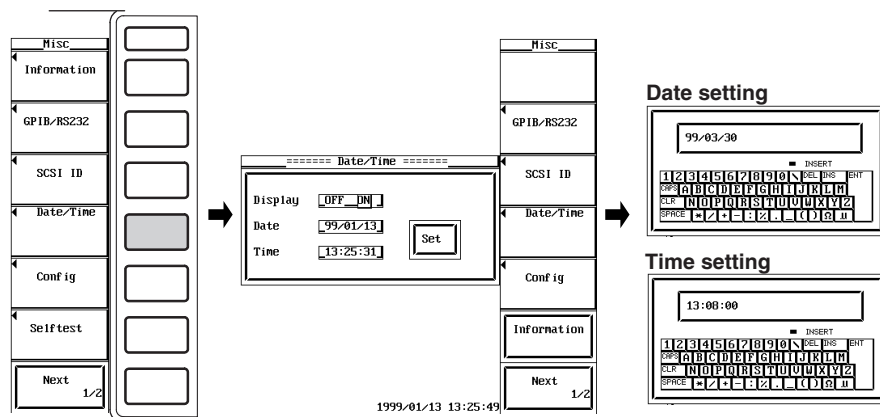

### Explanation

#### Turning ON/OFF the date/time display

You can select whether or not to display the date and time in the lower right corner of the screen.

- OFF : Do not display the date and time.
- ON : Display the date and time.

#### Setting the date and time

##### • Setting the date

You can set the date in the form YY/MM/DD (year/month/day). Set the lower two digits for the year. Set 00 to 98 for years 2000 to 2098, and 99 for the year 1999.

##### • Setting the time

You can set the time in the form HH : MM : SS (hour : minute : second). The hour is set using a 24-hour clock.

#### Confirming the new settings

When the date/time is turned ON/OFF, it is immediately reflected on the screen.

However, if you are changing the date and time, you must confirm the new settings. If you do not (abort the operation), the new settings will not take effect.

#### Note

---

- The date and time information is backed up with the lithium battery when the power is turned OFF.
  - The instrument contains leap year information. The instrument determines the leap year calendar when the new settings are confirmed. If you enter [2/29] on a non-leap year, an error message will be displayed.
-

# 4.1 Entering Values and Strings

## Entering Values

### By using the rotary knob

The observation time can be set regardless of the displayed menu.



### By using the jog shuttle

After selecting the setup parameter with the soft keys and the SELECT key, the value can be changed using the jog shuttle. The outer shuttle ring can be used step through the values in large increments. On some parameters, the arrow keys below the jog shuttle can be used to move among the digits.

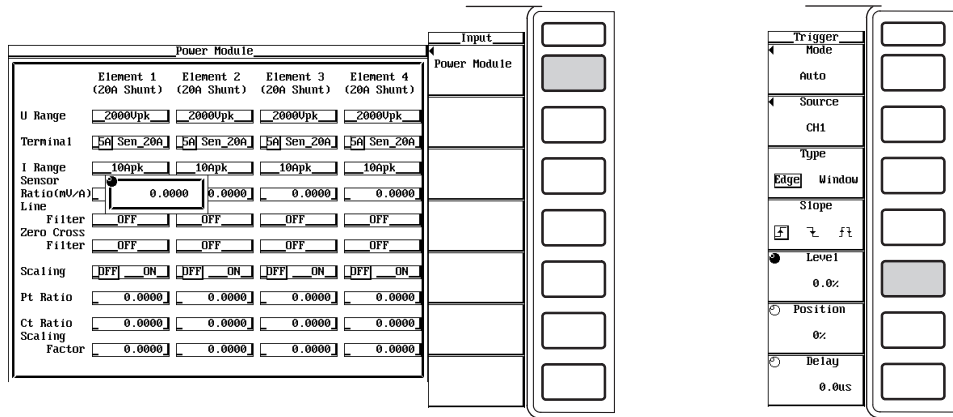

### Note

The parameters that can be changed using the jog shuttle are reset to their initial values when the RESET key is pressed.

## Entering Strings

The date/time, file name, and comment can be entered using the keyboard that is displayed on the screen. The jog shuttle, SELECT key, and arrow keys are used to operate the keyboard to enter the character strings. The keyboard that is displayed when creating equations for user-defined functions and waveform computations contain special keys. See the “Note” on the next page.

### Operating the keyboard

1. Turn the jog shuttle to select the character to be entered.
2. Pressing the SELECT key enters the character in the entry area.  
If there are strings already in the entry area as with the date and time, use the arrow keys to select the entry position.
3. Repeat steps 1 and 2 to enter all the characters.
4. After entering all the characters, select [ENT] on the keyboard and press the SELECT key. The string is confirmed and the keyboard disappears.

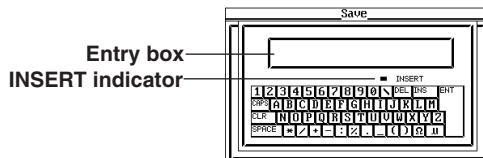

## 4.1 Entering Values and Strings

### Keys other than the character keys

- DEL or BS : Deletes the character before the entry position.
- INS : Switches the insert/overwrite mode. During the insert mode, the INSERT indicator on the keyboard lights. When a new character is entered in the insert mode, the new character is placed at the entry position and all following characters are moved forward.
- CLR : Clears all displayed characters.
- CAPS : Switches between upper case and lower case.
- SPACE : Enters a space.
- ENT : Confirms the displayed characters.

### Number of characters and types that can be used

Item	Number of Characters	Characters that can be Used
Date/time	Specified number	0 to 9 (/ :)
File name	1 to 8 characters	0 to 9, A to Z, %, _ , ( ) (parenthesis), -(minus sign)
Comment	0 to 25 characters*	all characters (includes spaces)

### Note

- Upper and lower case letters are not distinguished for file names. They are distinguished in comments. In addition, the following five file names cannot be used due to limitations of MS-DOS.  
AUX, CON, PRN, NUL, CLOCK
- When using the GP-IB or serial interface commands to enter a file name, the following symbols that do not exist on the keyboard of this instrument can be used.  
{ }
- The keyboard that is displayed when creating equations for user-defined functions and waveform computations is as follows. Long function names can be selected by pressing one key. Long equations can be temporarily held in the internal memory so that it can be used in other equations. The procedure to store equations in the internal memory is as follows. 1. After setting the equation, select [ENTER] on the keyboard. 2. When the SELECT key is pressed, the equation is confirmed as well as temporarily stored. The procedure to recall equations from the memory is as follows. 1. Press the  key on the keyboard and press the SELECT key to open a window. 2. A list of stored equations is displayed. Select the desired equation and press the SELECT key. The equation appears in the entry box on the keyboard. Take note of the following points. 1. When the equation is not correct and an error message is displayed, it is still stored in the memory. 2. If there is a character string in the memory, it is overwritten with the recalled equation. 3. Up to five equations can be stored. Beyond five, for all successive equations, the oldest equation is cleared.

The keyboard that is displayed when creating equations for user-defined functions

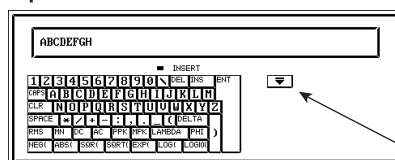

The window displaying the equation that is stored in the memory

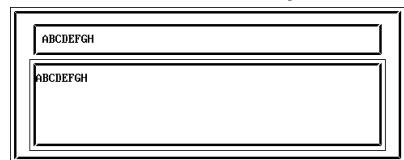

The keyboard that is displayed when creating equations for waveform computations

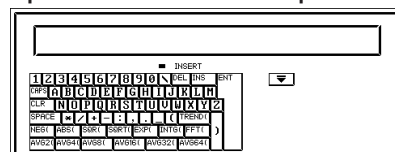

The key that is selected when displaying the above window

## 4.2 Initializing the Settings

### Keys

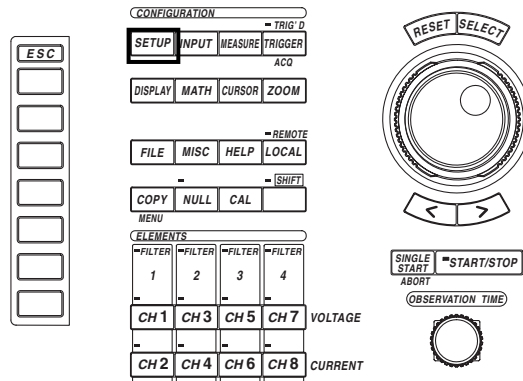

- The  mark indicates the keys that are used for the operation.
- To exit the menu during operation, press the ESC key.

### Procedure

#### Note

Confirm whether or not it is okay to initialize the settings before actually carrying out the initialization. You cannot restore the settings after they are initialized. We recommend that you save the setup parameters (see section 12.5) before initialization.

1. Press the SETUP key.
2. Press the [Initialize] soft key.

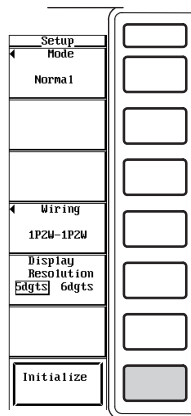

### Explanation

The values set with the keys can be reset to their factory default values. This function is useful when you wish to clear the previous settings or restart a configuration from the beginning. For details on the default settings, see Appendix 4.

#### Parameters that cannot be initialized

- Date and time.
- Settings related to saving and loading data.
- Settings related to screen image data output.
- Settings related to the GP-IB interface and serial interface.
- SCSI ID numbers. (The SCSI interface is optional.)

#### Initializing on Power Up

If the power switch is turned ON while pressing the RESET key, the instrument is powered up with the factory default settings in place. In this case, the settings related to the GP-IB interface, serial interface, and SCSI ID numbers are also initialized.

## 4.3 Starting/Stopping Data Acquisition

### Keys

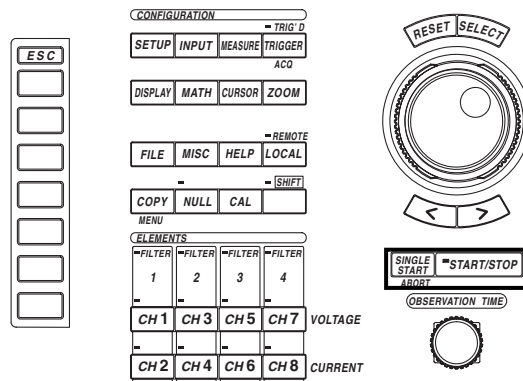

- The  mark indicates the keys that are used for the operation.
- To exit the menu during operation, press the ESC key.

### Procedure

#### Operation when the START/STOP key is pressed

Pressing the START/STOP key starts or stops the data acquisition operation. Data acquisition is in progress when the indicator on the key is lit.

#### Operation when the SINGLE START key is pressed

Pressing the SINGLE START key starts the data acquisition operation (the indicator on the START/STOP key lights). After the data are acquired once according to the trigger settings, the acquisition operation stops automatically (the indicator on the START/STOP key turns off).

#### Operation when the SHIFT+SINGLE START(ABORT) key is pressed

- When data acquisition has been started with the START/STOP key, pressing the SHIFT+SINGLE START(ABORT) key aborts the operation.
- When data acquisition to the memory is stopped, pressing the SHIFT+SINGLE START(ABORT) key clears the previously acquired data in the acquisition memory. Data related to numerical computation and waveform analysis are also cleared.



**Explanation****The difference between stopping the data acquisition using the START/STOP key and the SHIFT+SINGLE START(ABORT) key**

When the data acquisition is stopped using the START/STOP key, the acquisition operation stops after acquiring the display record length of sampled data. Therefore, numerical data can be measured, computed, and displayed and the waveform can be displayed.

When the data acquisition is aborted using the SHIFT+SINGLE START(ABORT) key, the acquisition stops immediately when the key is pressed. Therefore, numerical data cannot be measured, computed, or displayed and the waveform cannot be displayed. This condition can be avoided by dividing the record length. For information on dividing the record length, see section 6.2, "Selecting the Record Length for Acquiring Data."

**Conditions in which the START/STOP key and SINGLE START key are void**

- During Remote mode (REMOTE indicator is lit).
- While printing.
- While accessing the medium.

**Note**

- If the acquisition conditions are changed and the measurement is started, any previously acquired data in the acquisition memory are cleared.
- Attempting to access the storage medium while data acquisition in progress results in error.
- When the acquisition is stopped, the averaging operation is also stopped.
- When the acquisition is restarted, the averaging operation continues.

## 4.4 Performing Zero-level Compensation

### Keys

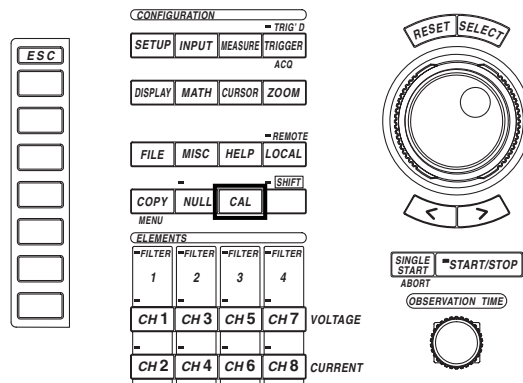

- The  mark indicates the keys that are used for the operation.
- To exit the menu during operation, press the ESC key.

### Procedures

Press the CAL key. Zero-level compensation is performed.

### Explanation

#### Zero-level compensation

This function creates a zero input condition using the instrument's internal circuitry and then sets the zero level to that value. Zero-level compensation must be performed to meet the specifications of this instrument (see chapter 17).

- Pressing the CAL key performs the zero-level compensation.
- Zero-level compensation is performed the first time a measurement is made after changing the measurement mode, measurement range, input terminal, and input filter.

#### Note

- For making accurate measurements, we recommend zero-level compensation be performed after warming up the instrument for at least 30 minutes. In addition, the ambient temperature needs to be within the specifications (see chapter 17) and be stable.
- If the measurement mode, measurement range, and input filter are not changed over a long period of time, the zero level may change due to changes in the environment surrounding the instrument. We recommend zero-level compensation be performed in this case.

## 4.5 Using the NULL Function

### Keys

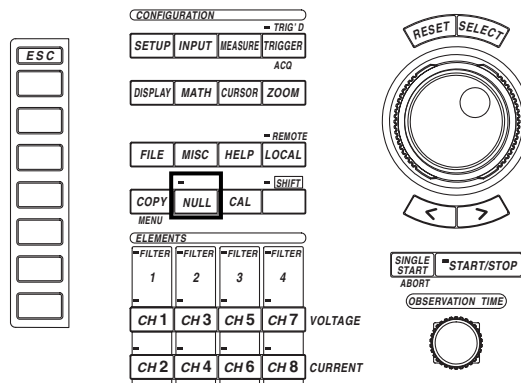

- The   mark indicates the keys that are used for the operation.
- To exit the menu during operation, press the ESC key.

### Procedures

Press the NULL key to activate the NULL function. The indicator on the NULL key lights.

### Explanation

#### NULL value

When the NULL function is turned ON, the NULL values are set to the Udc and Idc values (numerical data of the simple average of the voltage and current during the normal measurement mode, U(dc) and I(dc) during the harmonic measurement mode) as well as Speed and Torque (when using the motor module and the input signal from the sensor is a DC voltage) that were measured the previous time. If the previously measured Udc and Idc as well as Speed and Torque values do not exist, such as when the NULL function is turned ON without making a measurement after turning ON the power, Udc and Idc are set to zero.

#### Note

When setting the NULL value, we recommend the voltage and current measurement ranges be set as small as possible. The measurement resolution is higher when the measurement range is small which results in a more accurate measurement of the NULL values.

#### Measurement functions that are affected by the NULL function

The NULL values are subtracted from the sampled data. Therefore, all measurement functions are affected by the NULL values.

## 4.6 Using the Help Function

### Keys

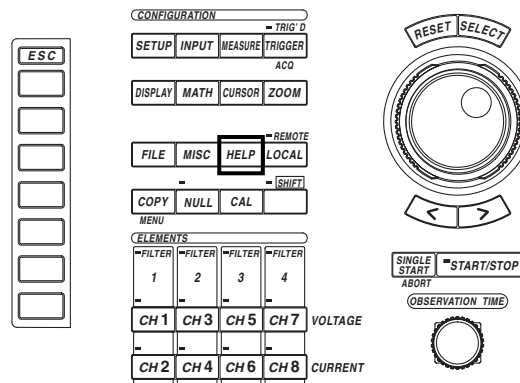

- The   mark indicates the keys that are used for the operation.
- To exit the menu during operation, press the ESC key.

### Procedures

#### Displaying the help window

1. Press the HELP key to open the help window.
2. Press the operation key or soft key corresponding to the setup parameters you wish to check. The setup data related to the pressed key are displayed.

#### Closing the help window

3. Press the HELP key when the help window is being displayed. The help window disappears.

### Explanation

When the HELP key is pressed, a help window is displayed that contains information related to the soft key menu or jog shuttle menu that was displayed immediately before the help key was pressed.

If you press a key while the help window is being displayed, help information related to the pressed key is displayed.

# 5.1 Selecting the Measurement Mode

«For a functional description, see section 1.2.»

### Keys

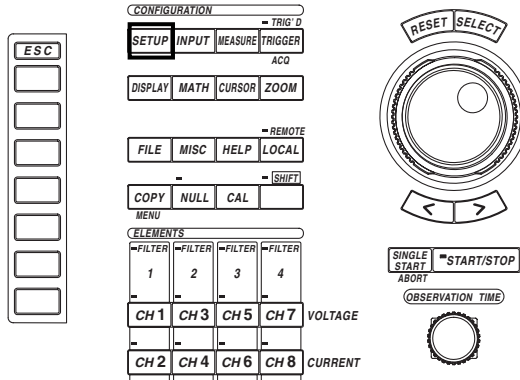

- The  mark indicates the keys that are used for the operation.
- To exit the menu during operation, press the ESC key.

### Procedure

1. Press the SETUP key to display the Setup menu.
2. Press the [Mode] soft key to display the measurement mode selection menu.
3. Press the [Normal] or [Harmonics] soft key to select the measurement mode.

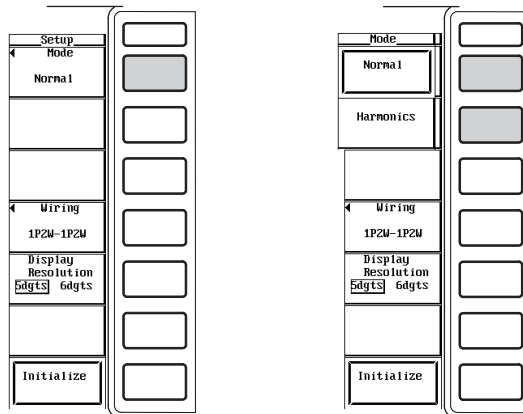

### Explanation

There are two measurement modes, normal measurement and harmonic measurement. The handling of the sampled data and the types of measurement functions vary depending on the mode. For details, see section 1.2, "Measurement Modes and Measurement/Computation Periods."

#### Selecting the measurement mode

Select from the following choices.

- Normal : The mode is set to normal measurement.
- Harmonics : The mode is set to harmonic measurement.

#### Note

The measurement mode cannot be switched while the data acquisition is in progress.

## 5.2 Selecting the Wiring Method

«For a functional description, see section 1.2.»

### Keys

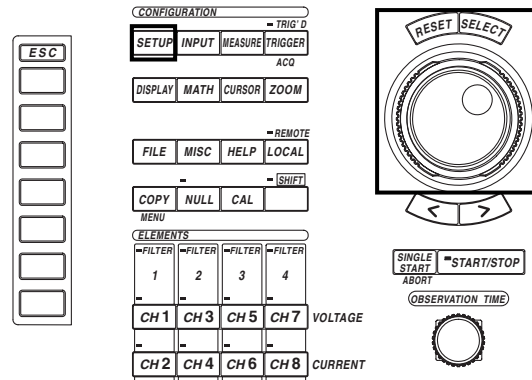

- The  mark indicates the keys that are used for the operation.
- To exit the menu during operation, press the ESC key.

### Procedure

1. Press the SETUP key to display the Setup menu.
2. Press the [Wiring] soft key to display the wiring method selection menu.
3. Turn the jog shuttle to select the wiring method.
4. Press the SELECT key to confirm the wiring method.

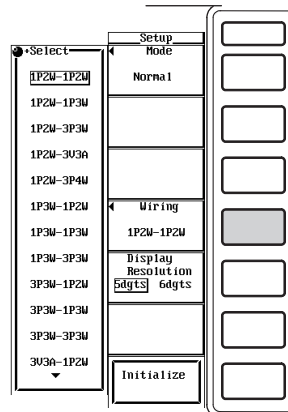

### Explanation

The wiring method is the method by which the signals that are input to each element are combined. The numerical data of  $\Sigma$ functions are determined according to the wiring method. The selectable wiring methods vary depending on which element slots have power measurement modules installed.

The wiring method can be selected from the table below.

The wiring symbols used in the table have the following meanings.

1P2W : single-phase, two-wire system, 1P3W : single-phase, three-wire system, 3P3W : three-phase, three-wire system, 3V3A : three-voltage, three-current system, 3P4W : three-phase, four-wire system.

- **When the power measurement module is installed only in the element number 1 slot**

The selection menu is not displayed.

**Wiring Method**      **Numerical Data of the  $\Sigma$ Function**

A-(B)

1P2W

- $\Sigma A$  : Displays the numerical data of element 1.
- $\Sigma B$  : No numerical data.

- **When the power measurement modules are installed in element number 1 and 2 slots**

Selectable Wiring Method A-(B)	Numerical Data of the $\Sigma$ Function
1P2W-1P2W	<ul style="list-style-type: none"> <li>• <math>\Sigma A</math> : Displays the numerical data of element 1.</li> <li>• <math>\Sigma B</math> : Displays the numerical data of element 2.</li> </ul>
1P3W	<ul style="list-style-type: none"> <li>• <math>\Sigma A</math> : Displays the numerical data when elements 1 and 2 are combined into a 1P3W system.</li> <li>• <math>\Sigma B</math> : No numerical data.</li> </ul>
3P3W	<ul style="list-style-type: none"> <li>• <math>\Sigma A</math> : Displays the numerical data when elements 1 and 2 are combined into a 3P3W system.</li> <li>• <math>\Sigma B</math> : No numerical data.</li> </ul>

- **When the power measurement modules are installed in element number 1, 2, and 3 slots**

Selectable Wiring Method A-(B)	Numerical Data of the $\Sigma$ Function
1P2W-1P2W	<ul style="list-style-type: none"> <li>• <math>\Sigma A</math> : Displays the numerical data of element 1.</li> <li>• <math>\Sigma B</math> : Displays the numerical data of element 2.</li> <li>* Element 3 is also handled as 1P2W. It does not affect <math>\Sigma A</math> and <math>\Sigma B</math>.</li> </ul>
1P2W-1P3W	<ul style="list-style-type: none"> <li>• <math>\Sigma A</math> : Displays the numerical data of element 1.</li> <li>• <math>\Sigma B</math> : Displays the numerical data when elements 2 and 3 are combined into a 1P3W system.</li> </ul>
1P2W-3P3W	<ul style="list-style-type: none"> <li>• <math>\Sigma A</math> : Displays the numerical data of element 1.</li> <li>• <math>\Sigma B</math> : Displays the numerical data when elements 2 and 3 are combined into a 3P3W system.</li> </ul>
1P3W-1P2W	<ul style="list-style-type: none"> <li>• <math>\Sigma A</math> : Displays the numerical data when elements 1 and 2 are combined into a 1P3W system.</li> <li>• <math>\Sigma B</math> : Displays the numerical data of element 3.</li> </ul>
3P3W-1P2W	<ul style="list-style-type: none"> <li>• <math>\Sigma A</math> : Displays the numerical data when elements 1 and 2 are combined into a 3P3W system.</li> <li>• <math>\Sigma B</math> : Displays the numerical data of element 3.</li> </ul>
3V3A	<ul style="list-style-type: none"> <li>• <math>\Sigma A</math> : Displays the numerical data when elements 1, 2, and 3 are combined into a 3V3A system.</li> <li>• <math>\Sigma B</math> : No numerical data.</li> </ul>
3P4W	<ul style="list-style-type: none"> <li>• <math>\Sigma A</math> : Displays the numerical data when elements 1, 2, and 3 are combined into a 3P4W system.</li> <li>• <math>\Sigma B</math> : No numerical data.</li> </ul>

## 5.2 Selecting the Wiring Method

- **When the power measurement modules are installed in element number 1, 2, 3, and 4 slots**

Selectable Wiring Method A-(B)	Numerical Data of the $\Sigma$ Function
1P2W-1P2W	<ul style="list-style-type: none"> <li>• <math>\Sigma A</math> : Displays the numerical data of element 1.</li> <li>• <math>\Sigma B</math> : Displays the numerical data of element 2.</li> <li>* Elements 3 and 4 are also handled as 1P2W. They do not affect <math>\Sigma A</math> and <math>\Sigma B</math>.</li> </ul>
1P2W-1P3W	<ul style="list-style-type: none"> <li>• <math>\Sigma A</math> : Displays the numerical data of element 1.</li> <li>• <math>\Sigma B</math> : Displays the numerical data when elements 2 and 3 are combined into a 1P3W system.</li> <li>* Element 4 is handled as 1P2W. It does not affect <math>\Sigma A</math> and <math>\Sigma B</math>.</li> </ul>
1P2W-3P3W	<ul style="list-style-type: none"> <li>• <math>\Sigma A</math> : Displays the numerical data of element 1.</li> <li>• <math>\Sigma B</math> : Displays the numerical data when elements 2 and 3 are combined into a 3P3W system.</li> <li>* Element 4 is handled as 1P2W. It does not affect <math>\Sigma A</math> and <math>\Sigma B</math>.</li> </ul>
1P2W-3V3A	<ul style="list-style-type: none"> <li>• <math>\Sigma A</math> : Displays the numerical data of element 1.</li> <li>• <math>\Sigma B</math> : Displays the numerical data when elements 2, 3, and 4 are combined into a 3V3A system.</li> </ul>
1P2W-3P4W	<ul style="list-style-type: none"> <li>• <math>\Sigma A</math> : Displays the numerical data of element 1.</li> <li>• <math>\Sigma B</math> : Displays the numerical data when elements 2, 3, and 4 are combined into a 3P4W system.</li> </ul>
1P3W-1P2W	<ul style="list-style-type: none"> <li>• <math>\Sigma A</math> : Displays the numerical data when elements 1 and 2 are combined into a 1P3W system.</li> <li>• <math>\Sigma B</math> : Displays the numerical data of element 3.</li> <li>* Element 4 is handled as 1P2W. It does not affect <math>\Sigma A</math> and <math>\Sigma B</math>.</li> </ul>
1P3W-1P3W	<ul style="list-style-type: none"> <li>• <math>\Sigma A</math> : Displays the numerical data when elements 1 and 2 are combined into a 1P3W system.</li> <li>• <math>\Sigma B</math> : Displays the numerical data when elements 3 and 4 are combined into a 1P3W system.</li> </ul>
1P3W-3P3W	<ul style="list-style-type: none"> <li>• <math>\Sigma A</math> : Displays the numerical data when elements 1 and 2 are combined into a 1P3W system.</li> <li>• <math>\Sigma B</math> : Displays the numerical data when elements 3 and 4 are combined into a 3P3W system.</li> </ul>
3P3W-1P2W	<ul style="list-style-type: none"> <li>• <math>\Sigma A</math> : Displays the numerical data when elements 1 and 2 are combined into a 3P3W system.</li> <li>• <math>\Sigma B</math> : Displays the numerical data of element 3.</li> <li>* Element 4 is handled as 1P2W. It does not affect <math>\Sigma A</math> and <math>\Sigma B</math>.</li> </ul>
3P3W-1P3W	<ul style="list-style-type: none"> <li>• <math>\Sigma A</math> : Displays the numerical data when elements 1 and 2 are combined into a 3P3W system.</li> <li>• <math>\Sigma B</math> : Displays the numerical data when elements 3 and 4 are combined into a 1P3W system.</li> </ul>
3P3W-3P3W	<ul style="list-style-type: none"> <li>• <math>\Sigma A</math> : Displays the numerical data when elements 1 and 2 are combined into a 3P3W system.</li> <li>• <math>\Sigma B</math> : Displays the numerical data when elements 3 and 4 are combined into a 3P3W system.</li> </ul>
3V3A-1P2W	<ul style="list-style-type: none"> <li>• <math>\Sigma A</math> : Displays the numerical data when elements 1, 2, and 3 are combined into a 3V3A system.</li> <li>• <math>\Sigma B</math> : Displays the numerical data of element 4.</li> </ul>
3P4W-1P2W	<ul style="list-style-type: none"> <li>• <math>\Sigma A</math> : Displays the numerical data when elements 1, 2, and 3 are combined into a 3P4W system.</li> <li>• <math>\Sigma B</math> : Displays the numerical data of element 4.</li> </ul>



### Note

---

- Check that the power measurement modules are installed in order starting from the element number 1 slot. If you leave the slots that have smaller element numbers empty, measurements will not be made properly. (For example, do not install a power measurement module into the element number 2 slot and leave the element number 1 slot empty. Do not install power measurement modules into element number 1 and 3 slots and leave the element number 2 slot empty.) For the procedures on installing the modules, see section 3.3, "Installing the Input Module."
  - When the sensor input module is installed into the element number 4 slot, only up to three power measurement modules can be installed. In this case, you cannot select a wiring method that uses four power measurement modules.
  - Select the wiring method that matches the actual wiring of the circuit. The method in determining the  $\Sigma$ functions varies depending on the wiring method. If the wiring method selection is not correct for the circuit, the measurement/computation results will not be correct.
  - When the data acquisition is stopped and you wish to determine the  $\Sigma$ functions for the case when the wiring method is switched, re-compute the numerical data (see section 10.1).
  - For details pertaining to the relationship between the wiring method and  $\Sigma$ functions, see Appendix 2.
-

## 5.3 Setting the Measurement Range during Direct Input

«For a functional description, see section 1.3.»

### Keys

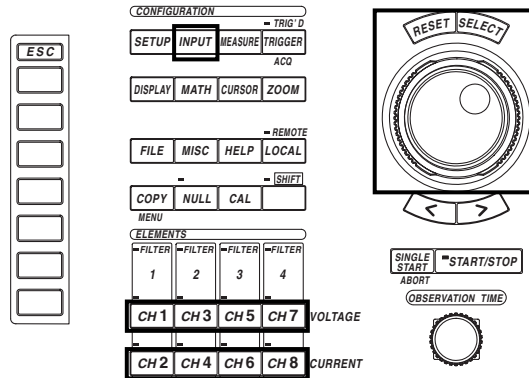

- The  mark indicates the keys that are used for the operation.
- To exit the menu during operation, press the ESC key.

### Procedure

#### Setting the Range Using the Full Screen Menu for Each Element

Sets the range of the power measurement module for each element.

1. Press the INPUT key to display the Input setting menu.  
On products (PZ4000) with firmware version before 2.01, only the [Power Module] soft key appears.
2. Press the [Power Module (Each)] soft key to display the power module setting dialog box.  
The menu does not appear for elements without modules. If the sensor input module is installed in the element number 4 slot, the menu for element 4 does not appear.

#### Setting the voltage range

3. Turn the jog shuttle to select the [U Range] of the element you wish to set.
4. Press the SELECT key to display the voltage range selection box.
5. Turn the jog shuttle to select the range from [2000Vpk] to [30Vpk] and [Auto].
6. Press the SELECT key to confirm the new voltage range.

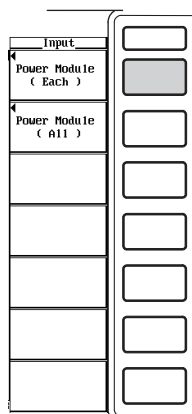

	Element 1 (20A Shunt)	Element 2 (20A Shunt)	Element 3 (20A Shunt)	Element 4 (20A Shunt)
U Range	20000pk	Select	20000pk	20000pk
Terminal	50 Sen 20A	20000pk	50 Sen 20A	50 Sen 20A
I Range	100pk	1200pk	100pk	100pk
Sensor Ratio(mV/A)	0.0000	600pk	0.0000	0.0000
Line Filter	OFF	300pk	OFF	OFF
Zero Cross Filter	OFF	200pk	OFF	OFF
Scaling	OFF ON	1200pk	OFF ON	OFF ON
Pt Ratio	0.0000	600pk	0.0000	0.0000
Ct Ratio	0.0000	300pk	0.0000	0.0000
Scaling Factor	0.0000	Auto	0.0000	0.0000

**Setting the current range**

• **Selecting the current input terminal**

3. Turn the jog shuttle to select the [Terminal] of the element you wish to set.
4. Press the SELECT key to select [5A] or [20A].

[20A] cannot be selected on the power measurement module 253751.

• **Selecting the voltage range**

5. Turn the jog shuttle to select the [I Range] of the element you wish to set.
6. Press the SELECT key to display the current range selection box.
7. Turn the jog shuttle to select the current range from [10Apk] to [0.1Apk] and [Auto] or [100Apk] to [1Apk] and [Auto] when the current input terminal is [5A] or [20A], respectively.
8. Press the SELECT key to confirm the new current range.

Power Module				
	Element 1 (20A Shunt)	Element 2 (20A Shunt)	Element 3 (20A Shunt)	Element 4 (20A Shunt)
U Range	2000Upk	2000Upk	2000Upk	2000Upk
Terminal	5A Sen_20A	5A Sen_20A	5A Sen_20A	5A Sen_20A
I Range	100pk	100pk	100pk	100pk
Sensor Ratio(mV/A)	0.0000	0.0000	0.0000	0.0000
Line Filter	OFF	OFF	OFF	OFF
Zero Cross Filter	OFF	OFF	OFF	OFF
Scaling	OFF ON	OFF ON	OFF ON	OFF ON
Pt Ratio	0.0000	0.0000	0.0000	0.0000
Ct Ratio	0.0000	0.0000	0.0000	0.0000
Scaling Factor	0.0000	0.0000	0.0000	0.0000

Power Module				
	Element 1 (20A Shunt)	Element 2 (20A Shunt)	Element 3 (20A Shunt)	Element 4 (20A Shunt)
U Range	2000Upk	2000Upk	2000Upk	2000Upk
Terminal	5A Sen_20A	5A Sen_20A	5A Sen_20A	5A Sen_20A
I Range	100pk	Select	100pk	100pk
Sensor Ratio(mV/A)	0.0000	100pk	0.0000	0.0000
Line Filter	OFF	40pk	OFF	OFF
Zero Cross Filter	OFF	20pk	OFF	OFF
Scaling	OFF ON	10pk	OFF ON	OFF ON
Pt Ratio	0.0000	0.40pk	0.0000	0.0000
Ct Ratio	0.0000	0.20pk	0.0000	0.0000
Scaling Factor	0.0000	0.10pk	0.0000	0.0000
		Auto		

### 5.3 Setting the Measurement Range during Direct Input

#### Setting the Range Using the Full Screen Menu for All Elements

Sets the range of the power measurement module for all elements at once. This is applicable to products (PZ4000) with firmware version 2.01 or later.

1. Press the INPUT key to display the Input setting menu.
2. Press the [Power Module (All)] soft key to display the All power module setting dialog box.

The menu does not appear for elements without modules. If the sensor input module is installed in the element number 4 slot, the menu for element 4 does not appear.

#### Setting the voltage range

3. Turn the jog shuttle to select the [U Range] of element 1.
4. Press the SELECT key to display the voltage range selection box.
5. Turn the jog shuttle to select the range from [2000Vpk] to [30Vpk] and [Auto].
6. Press the SELECT key to confirm the new voltage range. The [U Range] of all other modules that are displayed are set to the same voltage range.

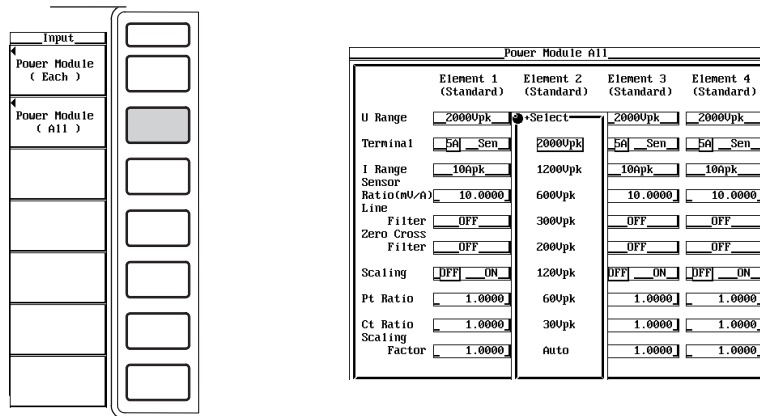

#### Setting the current range

##### • Selecting the current input terminal

3. Turn the jog shuttle to select the [Terminal] of element 1.
4. Press the SELECT key to select [5A] or [20A]. The [Terminal] of all other modules that are displayed are set to the same value ([5A] or [20A]).
  - [20A] cannot be selected on the power measurement module 253751.
  - Even when [20A] is selected for the power measurement module 253752 of element 1, other modules that are not 253752s are not set to [20A].
  - When element 1 is a power measurement module 253751, [20A] cannot be selected. Thus, other modules, even if they are 253752s, cannot be set to [20A]. For the procedure to set [20A] in this case, see the previous section, "Setting the Range Using the Full Screen Menu for Each Element."

##### • Selecting the current range

5. Turn the jog shuttle to select the [I Range] of element 1.
6. Press the SELECT key to display the current range selection box.
7. Turn the jog shuttle to select the current range from [10Apk] to [0.1Apk] and [Auto] or [100Apk] to [1Apk] and [Auto] when the current input terminal is [5A] or [20A], respectively.
8. Press the SELECT key to confirm the new current range. The [I Range] of all other modules that are set to the same current input terminal [Terminal] as element 1 are set to the same current range.

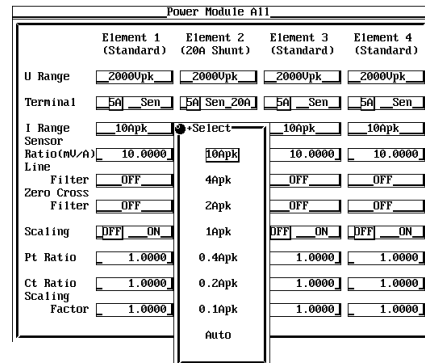
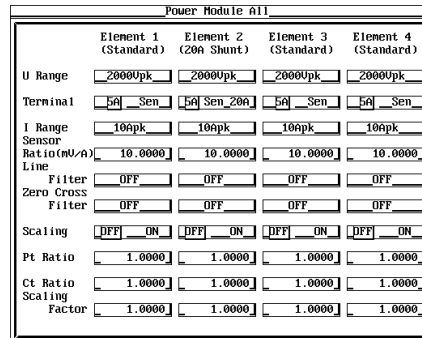

## Setting the Range Using the Channel Setting Menu

### Setting the voltage range

1. Select the desired channel key from the CH1, CH3, CH5, and CH7 keys. The channel setting menu appears.  
If the CH7 key is pressed when the motor module is installed in the element number 4 slot, the menu for the rotating speed signal input appears. For the procedure, see chapter 15.
2. Press the [U Range] soft key to display the voltage range selection box.
3. Turn the jog shuttle to select the range from [2000Vpk] to [30Vpk] and [Auto].
4. Press the SELECT key to confirm the new voltage range.

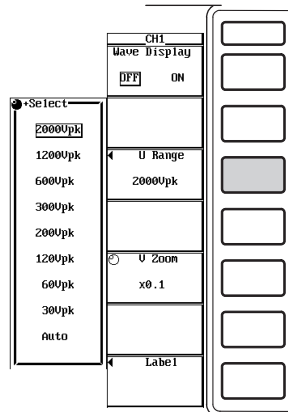

### Setting the current range

1. Select the desired channel key from the CH2, CH4, CH6, and CH8 keys. The channel setting menu appears.  
If the CH8 key is pressed when the motor module is installed in the element number 4 slot, the menu for the torque signal input appears. For the procedure, see chapter 15.

#### • Selecting the current input terminal

2. Press the [Terminal] soft key to select [5A] or [20A].  
[20A] cannot be selected on the power measurement module 253751.

#### • Selecting the current range

3. Press the [I Range] soft key to display the current range selection box.
4. Turn the jog shuttle to select the current range from [10Apk] to [0.1Apk] and [Auto] or [100Apk] to [1Apk] and [Auto] when the current input terminal is [5A] or [20A], respectively.
5. Press the SELECT key to confirm the new current range.

### 5.3 Setting the Measurement Range during Direct Input

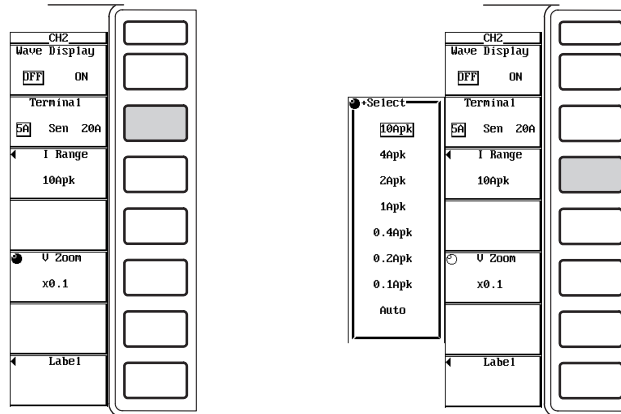

#### Explanation

#### Setting the voltage and current ranges

The voltage and current ranges can be set using the full screen menu or channel setting menu.

There are two types of ranges, fixed and auto.

- **Fixed range**

- Voltage range

Select 2000Vpk, 1200Vpk, 600Vpk, 300Vpk, 200Vpk, 120Vpk, 60Vpk, or 30Vpk.

- Current range

- For the 5-A current input terminal

Select 10Apk, 4Apk, 2Apk, 1Apk, 0.4Apk, 0.2Apk, or 0.1Apk.

- For the 20-A current input terminal

Select 100Apk, 40Apk, 20Apk, 10Apk, 4Apk, 2Apk, or 1Apk.

#### Note

To set the range, refer to the peak value of the input signal. For example, if a 100-Vrms sinusoid is to be applied, the peak value is approximately 141 V. Thus, set the range to [200Vpk].

- **Auto range**

Select [Auto] for the range setting to enable auto range. The range switches automatically depending on the amplitude of the input signal as follows. The different ranges used in the auto mode are the same as those available for fixed range selection.

- Increasing the range

- When the numerical data U+pk and U-pk exceed 80% of the current voltage range, the voltage range is increased for the next data acquisition.

- When the numerical data I+pk and I-pk exceed 80% of the current current range, the current range is increased for the next data acquisition.

- Decreasing the range

- When the numerical data U+pk and U-pk fall below 15% of the current voltage range, the voltage range is decreased for the next data acquisition.

- When the numerical data I+pk and I-pk fall below 15% of the current current range, the current range is increased for the next data acquisition.

**Note**

- When numerical data are not measured or computed (see section 10.1), auto range cannot be used. You can select [Auto] from the menu, but it is not activated. The range that was most recently selected is used.
- When pulse waveforms that are not periodic are input during auto range, the range may not remain constant. In this case, use a fixed range setting.

**Power range**

The measurement ranges (power range) of active power (P), apparent power (S), and reactive power (Q) are as follows.

Wiring Method	Power Range
1P2W (single-phase two-wire)	voltage range × current range
1P3W (single-phase three-wire)	voltage range × current range × 2
3P3W (three-phase three-wire)	(when the voltage and current ranges on the
3V3A (three-voltage, three-current)	corresponding elements are set to the same range)
3P4W (three-phase four-wire)	voltage range × current range × 3
	(when the voltage and current ranges on the
	corresponding elements are set to the same range)

- When the result of the voltage range × current range exceeds 1000 W (VA, or var), the displayed unit changes to kW (kVA or kvar).
- The maximum displayed value is 99999 (5 digits) or 999999 (6 digits). For digit selection, see section 8.1, “Selecting the Number of Displayed Digits.”

**Note**

Because the voltage and current ranges switch independently according to the input conditions, different power ranges may be set for the same power value.

### 5.3 Setting the Measurement Range during Direct Input

The actual values of the combinations of the voltage and current ranges and the power range are listed below (according to the table on the previous page). The tables show the different ranges for active power. The same ranges are set for apparent power (unit : VA) and reactive power (unit : var). Just replace the unit with VA or var when looking at the tables. For the number of displayed digits, see section 8.1, "Selecting the Number of Displayed Digits."

#### Wiring Method : 1P2W

Current Range [Apk]	Displayed digits	Voltage Range [Vpk]							
		30	60	120	200	300	600	1200	2000
0.1	5 digits	3.0000 W	6.0000 W	12.000 W	20.000 W	30.000 W	60.000 W	120.00 W	200.00 W
	6 digits	3.00000 W	6.00000 W	12.0000 W	20.0000 W	30.0000 W	60.0000 W	120.000 W	200.000 W
0.2	5 digits	6.0000 W	12.000 W	24.000 W	40.000 W	60.000 W	120.00 W	240.00 W	400.00 W
	6 digits	6.00000 W	12.0000 W	24.0000 W	40.0000 W	60.0000 W	120.000 W	240.000 W	400.000 W
0.4	5 digits	12.000 W	24.000 W	48.000 W	80.000 W	120.00 W	240.00 W	480.00 W	800.00 W
	6 digits	12.0000 W	24.0000 W	48.0000 W	80.0000 W	120.000 W	240.000 W	480.000 W	800.000 W
1	5 digits	30.000 W	60.000 W	120.00 W	200.00 W	300.00 W	600.00 W	1.2000 kW	2.0000 kW
	6 digits	30.0000 W	60.0000 W	120.000 W	200.000 W	300.000 W	600.000 W	1.20000 kW	2.00000 kW
2	5 digits	60.000 W	120.00 W	240.00 W	400.00 W	600.00 W	1.2000 kW	2.4000 kW	4.0000 kW
	6 digits	60.0000 W	120.000 W	240.000 W	400.000 W	600.000 W	1.20000 kW	2.40000 kW	4.00000 kW
4	5 digits	120.00 W	240.00 W	480.00 W	800.00 W	1.2000 kW	2.4000 kW	4.8000 kW	8.0000 kW
	6 digits	120.000 W	240.000 W	480.000 W	800.000 W	1.20000 kW	2.40000 kW	4.80000 kW	8.00000 kW
10	5 digits	300.00 W	600.00 W	1.2000 kW	2.0000 kW	3.0000 kW	6.0000 kW	12.000 kW	20.000 kW
	6 digits	300.000 W	600.000 W	1.20000 kW	2.00000 kW	3.00000 kW	6.00000 kW	12.0000 kW	20.0000 kW
20	5 digits	600.00 W	1.2000 kW	2.4000 kW	4.0000 kW	6.0000 kW	12.000 kW	24.000 kW	40.000 kW
	6 digits	600.000 W	1.20000 kW	2.40000 kW	4.00000 kW	6.00000 kW	12.0000 kW	24.0000 kW	40.0000 kW
40	5 digits	1.2000 kW	2.4000 kW	4.8000 kW	8.0000 kW	12.000 kW	24.000 kW	48.000 kW	80.000 kW
	6 digits	1.20000 kW	2.40000 kW	4.80000 kW	8.00000 kW	12.0000 kW	24.0000 kW	48.0000 kW	80.0000 kW
100	5 digits	3.0000 kW	6.0000 kW	12.000 kW	20.000 kW	30.000 kW	60.000 kW	120.00 kW	200.00 kW
	6 digits	3.00000 kW	6.00000 kW	12.0000 kW	20.0000 kW	30.0000 kW	60.0000 kW	120.000 kW	200.000 kW

#### Wiring Method : 1P3W, 3P3W, 3V3A

Current Range [Apk]	Displayed digits	Voltage Range [Vpk]							
		30	60	120	200	300	600	1200	2000
0.1	5 digits	6.0000 W	12.000 W	24.000 W	40.000 W	60.000 W	120.00 W	240.00 W	400.00 W
	6 digits	6.00000 W	12.0000 W	24.0000 W	40.0000 W	60.0000 W	120.000 W	240.000 W	400.000 W
0.2	5 digits	12.000 W	24.000 W	48.000 W	80.000 W	120.00 W	240.00 W	480.00 W	800.00 W
	6 digits	12.0000 W	24.0000 W	48.0000 W	80.0000 W	120.000 W	240.000 W	480.000 W	800.000 W
0.4	5 digits	24.000 W	48.000 W	96.000 W	160.00 W	240.00 W	480.00 W	960.00 W	1.6000 kW
	6 digits	24.0000 W	48.0000 W	96.0000 W	160.000 W	240.000 W	480.000 W	960.000 W	1.60000 kW
1	5 digits	60.000 W	120.00 W	240.00 W	400.00 W	600.00 W	1.2000 kW	2.4000 kW	4.0000 kW
	6 digits	60.0000 W	120.000 W	240.000 W	400.000 W	600.000 W	1.20000 kW	2.40000 kW	4.00000 kW
2	5 digits	120.00 W	240.00 W	480.00 W	800.00 W	1.2000 kW	2.4000 kW	4.8000 kW	8.0000 kW
	6 digits	120.000 W	240.000 W	480.000 W	800.000 W	1.20000 kW	2.40000 kW	4.80000 kW	8.00000 kW
4	5 digits	240.00 W	480.00 W	960.00 W	160.00 W	2.4000 kW	4.8000 kW	9.6000 kW	16.000 kW
	6 digits	240.000 W	480.000 W	960.000 W	160.000 W	2.40000 kW	4.80000 kW	9.60000 kW	16.0000 kW
10	5 digits	600.00 W	1.2000 kW	2.4000 kW	4.0000 kW	6.0000 kW	12.000 kW	24.000 kW	40.000 kW
	6 digits	600.000 W	1.20000 kW	2.40000 kW	4.00000 kW	6.00000 kW	12.0000 kW	24.0000 kW	40.0000 kW
20	5 digits	1.2000 kW	2.4000 kW	4.8000 kW	8.0000 kW	12.000 kW	24.000 kW	48.000 kW	80.000 kW
	6 digits	1.20000 kW	2.40000 kW	4.80000 kW	8.00000 kW	12.0000 kW	24.0000 kW	48.0000 kW	80.0000 kW
40	5 digits	2.4000 kW	4.8000 kW	9.6000 kW	16.000 kW	24.000 kW	48.000 kW	96.000 kW	160.00 kW
	6 digits	2.40000 kW	4.80000 kW	9.60000 kW	16.0000 kW	24.0000 kW	48.0000 kW	96.0000 kW	160.000 kW
100	5 digits	6.0000 kW	12.000 kW	24.000 kW	40.000 kW	60.000 kW	120.00 kW	240.00 kW	400.00 kW
	6 digits	6.00000 kW	12.0000 kW	24.0000 kW	40.0000 kW	60.0000 kW	120.000 kW	240.000 kW	400.000 kW



### 5.3 Setting the Measurement Range during Direct Input

Wiring Method: 3P4W

Current Range [Apk]	Displayed digits	Voltage Range [Vpk]							
		30	60	120	200	300	600	1200	2000
0.1	5 digits	9.0000 W	18.000 W	36.000 W	60.000 W	90.000 W	180.00 W	360.00 W	600.00 W
	6 digits	9.00000 W	18.0000 W	36.0000 W	60.0000 W	90.0000 W	180.000 W	360.000 W	600.000 W
0.2	5 digits	18.000 W	36.000 W	72.000 W	120.00 W	180.00 W	360.00 W	720.00 W	1.2000 kW
	6 digits	18.0000 W	36.0000 W	72.0000 W	120.000 W	180.000 W	360.000 W	720.000 W	1.20000 kW
0.4	5 digits	36.000 W	72.000 W	144.00 W	240.00 W	360.00 W	720.00 W	1.4400 kW	2.4000 kW
	6 digits	36.0000 W	72.0000 W	144.000 W	240.000 W	360.000 W	720.000 W	1.44000 kW	2.40000 kW
1	5 digits	90.000 W	180.00 W	360.00 W	600.00 W	900.00 W	1.8000 kW	3.6000 kW	6.0000 kW
	6 digits	90.0000 W	180.000 W	360.000 W	600.000 W	900.000 W	1.80000 kW	3.60000 kW	6.00000 kW
2	5 digits	180.00 W	360.00 W	720.00 W	1200.0 W	1.8000 kW	3.6000 kW	7.2000 kW	12.000 kW
	6 digits	180.000 W	360.000 W	720.000 W	1200.00 W	1.80000 kW	3.60000 kW	7.20000 kW	12.0000 kW
4	5 digits	360.00 W	720.00 W	1.4400 kW	2.4000 kW	3.6000 kW	7.2000 kW	14.400 kW	24.000 kW
	6 digits	360.000 W	720.000 W	1.44000 kW	2.40000 kW	3.60000 kW	7.20000 kW	14.4000 kW	24.0000 kW
10	5 digits	900.00 W	1.8000 kW	3.6000 kW	6.0000 kW	9.0000 kW	18.000 kW	36.000 kW	60.000 kW
	6 digits	900.000 W	1.80000 kW	3.60000 kW	6.00000 kW	9.00000 kW	18.0000 kW	36.0000 kW	60.0000 kW
20	5 digits	1.8000 kW	3.6000 kW	7.2000 kW	12.000 kW	18.000 kW	36.000 kW	72.000 kW	120.00 kW
	6 digits	1.80000 kW	3.60000 kW	7.20000 kW	12.0000 kW	18.0000 kW	36.0000 kW	72.0000 kW	120.000 kW
40	5 digits	3.6000 kW	7.2000 kW	14.400 kW	24.000 kW	36.000 kW	72.000 kW	144.00 kW	240.00 kW
	6 digits	3.60000 kW	7.20000 kW	14.4000 kW	24.0000 kW	36.0000 kW	72.0000 kW	144.000 kW	240.000 kW
100	5 digits	9.0000 kW	18.000 kW	36.000 kW	60.000 kW	90.000 kW	180.00 kW	360.00 kW	600.00 kW
	6 digits	9.00000 kW	18.0000 kW	36.0000 kW	60.0000 kW	90.0000 kW	180.000 kW	360.000 kW	600.000 kW

## 5.4 Setting the Measurement Range when Using an External Current Sensor

«For a functional description, see section 1.3.»

### Keys

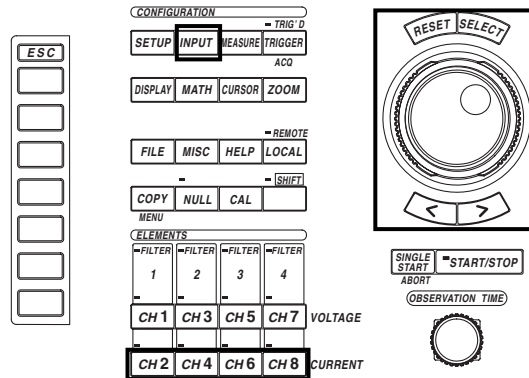

- The  mark indicates the keys that are used for the operation.
- To exit the menu during operation, press the ESC key.

### Procedure

#### Setting the Range Using the Full Screen Menu for Each Element

Sets the range of the power measurement module for each element.

1. Press the INPUT key to display the Input setting menu.  
On products (PZ4000) with firmware version before 2.01, only the [Power Module] soft key appears.
2. Press the [Power Module (Each)] soft key to display the power module setting dialog box.  
The menu does not appear for elements without modules. If the sensor input module is installed in the element number 4 slot, the menu for element 4 does not appear.

#### Selecting the current sensor input connector

3. Turn the jog shuttle to select the [Terminal] of the element you wish to set.
4. Press the SELECT key to select [Sen].

#### Selecting the current sensor range

5. Turn the jog shuttle to select the [I Range] of the element you wish to set.
6. Press the SELECT key to display the current sensor range selection box.
7. Turn the jog shuttle to select the range from [1000mVpk] to [100mVpk] and [Auto].
8. Press the SELECT key to confirm the new current sensor range.

## 5.4 Setting the Measurement Range when Using an External Current Sensor

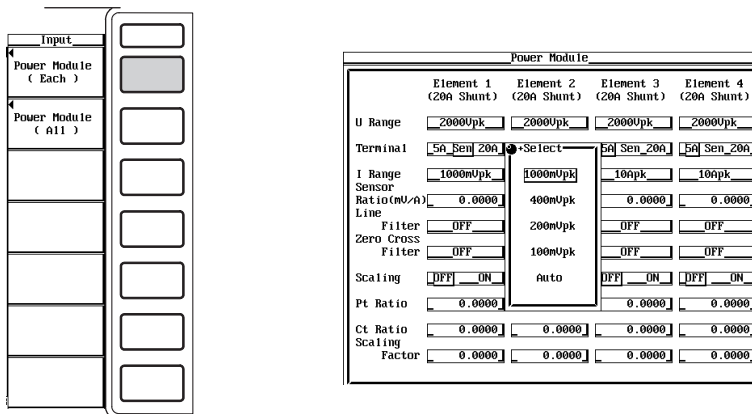

### Setting the current sensor transformation ratio

9. Turn the jog shuttle to select the [Sensor Ratio(mV/A)] of the element you wish to set.
10. Press the SELECT key to display the current sensor transformation ratio setting box.
11. Turn the jog shuttle to set the transformation ratio.  
For the procedures related to entering values using the jog shuttle, see section 4.1, "Entering Values and Strings."
12. Press the SELECT key or the ESC key to close the setting box.

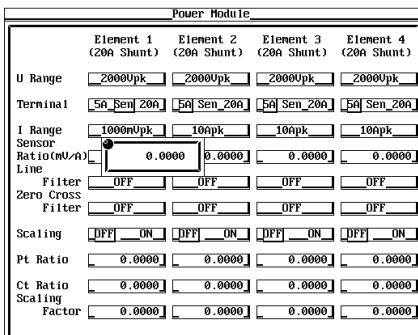

## 5.4 Setting the Measurement Range when Using an External Current Sensor

### Setting the Range Using the Full Screen Menu for All Elements

Sets the range of the power measurement module for all elements at once. This is applicable to products (PZ4000) with firmware version 2.01 or later.

1. Press the INPUT key to display the Input setting menu.
2. Press the [Power Module (All)] soft key to display the All power module setting dialog box.

The menu does not appear for elements without modules. If the sensor input module is installed in the element number 4 slot, the menu for element 4 does not appear.

### Selecting the current sensor input connector

3. Turn the jog shuttle to select the [Terminal] of element 1.
4. Press the SELECT key to select [Sen]. The [Terminal] of all other modules that are displayed are set to [Sen].

### Selecting the current sensor range

5. Turn the jog shuttle to select the [I Range] of element 1.
6. Press the SELECT key to display the current sensor range selection box.
7. Turn the jog shuttle to select the range from [1000mVpk] to [100mVpk] and [Auto].
8. Press the SELECT key to confirm the new current sensor range. The [I Range] of all other modules that are set to the same current input terminal [Terminal] as element 1 are set to the same current range.

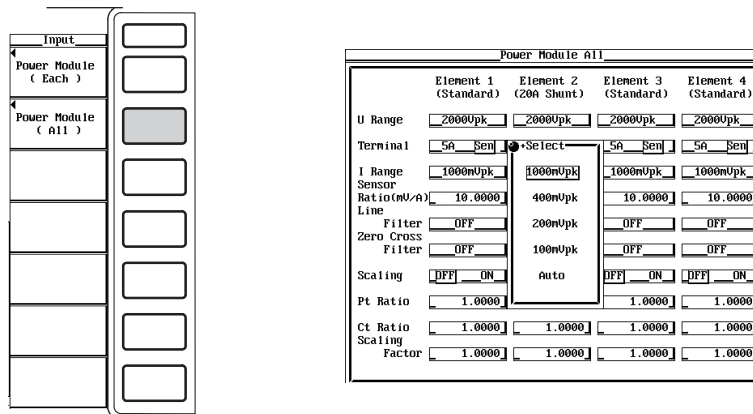

### Setting the current sensor transformation ratio

9. Turn the jog shuttle to select the [Sensor Ratio(mV/A)] of element 1.
10. Press the SELECT key to display the current sensor transformation ratio setting box.
11. Turn the jog shuttle to set the transformation ratio.  
For the procedures related to entering values using the jog shuttle, see section 4.1, "Entering Values and Strings."
12. Press the SELECT key or the ESC key to close the setting box. The [Sensor Ratio(mV/A)] of all other modules that are displayed are set to the same transformation ratio.

## 5.4 Setting the Measurement Range when Using an External Current Sensor

Power Module All				
	Element 1 (Standard)	Element 2 (20A Shunt)	Element 3 (Standard)	Element 4 (Standard)
U Range	2000Upk	2000Upk	2000Upk	2000Upk
Terminal	5A [Sen]	5A [Sen] 20A	5A [Sen]	5A [Sen]
I Range	1000mUpk	1000mUpk	1000mUpk	1000mUpk
Sensor Ratio(mV/A)	10.0000	0.0000	10.0000	10.0000
Line Filter	OFF	OFF	OFF	OFF
Zero Cross Filter	OFF	OFF	OFF	OFF
Scaling	OFF ON	OFF ON	OFF ON	OFF ON
Pt Ratio	1.0000	1.0000	1.0000	1.0000
Ct Ratio	1.0000	1.0000	1.0000	1.0000
Scaling Factor	1.0000	1.0000	1.0000	1.0000

### Setting the Range Using the Channel Setting Menu

- Select the desired channel key from the CH2, CH4, CH6, and CH8 keys. The channel setting menu appears.  
If the CH8 key is pressed when the motor module is installed in the element number 4 slot, the menu for the torque signal input appears. For the procedure, see chapter 15.

### Selecting the current sensor input connector

- Press the [Terminal] soft key to select [Sen].

### Selecting the current sensor range

- Press the [Sensor Range] soft key to display the current sensor range selection box.
- Turn the jog shuttle to select the range from [1000mVpk] to [100mVpk] and [Auto].
- Press the SELECT key to confirm the new current sensor range.

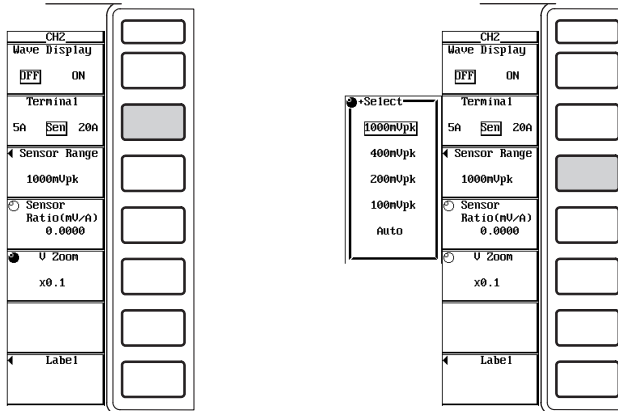

## 5.4 Setting the Measurement Range when Using an External Current Sensor

### Setting the current sensor transformation ratio

6. Press the [Sensor Ratio(mV/A)] soft key.
7. Turn the jog shuttle to set the transformation ratio.

For the procedures related to entering values using the jog shuttle, see section 4.1, "Entering Values and Strings."

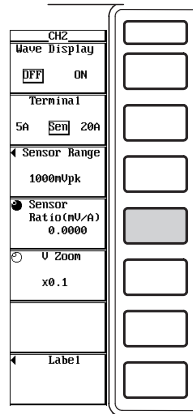

### Explanation

The output of current sensors such as shunts and clamps can be input to the current sensor connector of the input module so that they can be measured.

### Selecting the current sensor input connector

To measure the current using the input signal from the current sensor input connector, [Sen] must be selected for the [Terminal] and then the current sensor range and current sensor transformation ratio must be set.

### Selecting the current sensor range

There are two types of ranges, fixed and auto.

- **Fixed range**

Select 1000mVpk, 400mVpk, 200mVpk, or 100mVpk.

- **Auto range**

Select [Auto] at the range setting to enable auto range. The range switches automatically depending on the amplitude of the input signal. The conditions for which the range changes and the precautions are the same as the description given in section 5.3, "Setting the Measurement Range during Direct Input." The different ranges used in the auto mode are the same as those available for fixed range selection as shown above.

### Setting the current sensor transformation ratio

The ratio can be set in the range from 0.0001 to 99999.9999.

---

## 5.4 Setting the Measurement Range when Using an External Current Sensor

### Configuration example of the current sensor range and transformation ratio

For example, when using a current sensor that outputs 10 mV when 1 A of current is flowing, to measure a current with a maximum value of 100 Apk, the equation becomes  $10 \text{ mV/A} \times 100 \text{ Apk} = 1000 \text{ mVpk}$ . Therefore, set 1000 mVpk for the current sensor range, and 10 mV/A for the current sensor transformation ratio.

### Note

When attempting to directly read the current of the circuit under measurement by multiplying the output of the external current sensor by the transformation ratio, turn OFF the external PT/CT scaling function (see section 5.5). If it is turned ON, the value will be multiplied by the CT ratio.

---

## 5.5 Setting the Scaling Function when using an External PT or CT

«For a functional description, see section 1.3.»

### Keys

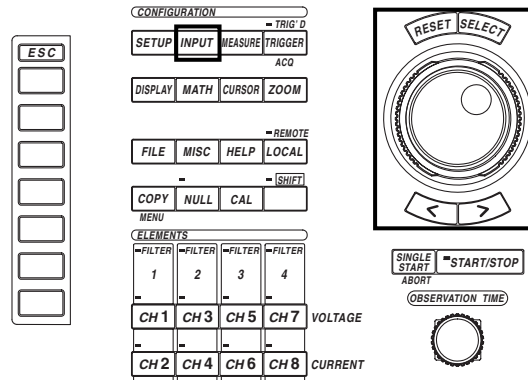

- The  mark indicates the keys that are used for the operation.
- To exit the menu during operation, press the ESC key.

### Procedure

#### Setting the Scaling Function for Each Element

Sets the scaling function of the power measurement module for each element.

1. Press the INPUT key to display the Input setting menu.  
On products (PZ4000) with firmware version before 2.01, only the [Power Module] soft key appears.
2. Press the [Power Module (Each)] soft key to display the power module setting dialog box.  
The menu does not appear for elements without modules. If the sensor input module is installed in the element number 4 slot, the menu for element 4 does not appear.

#### Turn ON/OFF the scaling function

3. Turn the jog shuttle to select the [Scaling] of the element you wish to set.
4. Press the SELECT key to select [ON] or [OFF].

#### Setting the PT ratio

3. Turn the jog shuttle to select the [PT Ratio] of the element you wish to set.
4. Press the SELECT key to display the PT ratio setting box.
5. Turn the jog shuttle to set the PT ratio.  
For the procedures related to entering values using the jog shuttle, see section 4.1, "Entering Values and Strings."
6. Press the SELECT key or the ESC key to close the setting box.



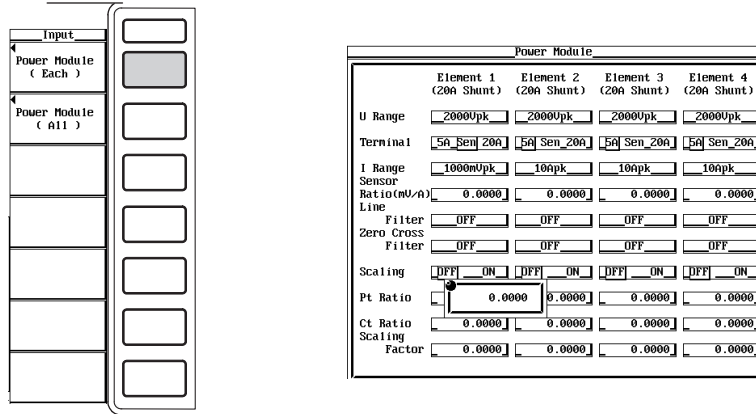

**Setting the CT ratio**

- Turn the jog shuttle to select the [CT Ratio] of the element you wish to set.
- Press the SELECT key to display the CT ratio setting box.
- Turn the jog shuttle to set the CT ratio.  
For the procedures related entering values using the jog shuttle, see section 4.1, "Entering Values and Strings."
- Press the SELECT key or the ESC key to close the setting box.

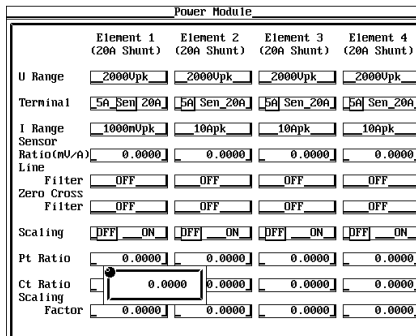

**Setting the power coefficient**

- Turn the jog shuttle to select the [Scaling Factor] of the element you wish to set.
- Press the SELECT key to display the power coefficient setting box.
- Turn the jog shuttle to set the power coefficient.  
For the procedures related to entering values using the jog shuttle, see section 4.1, "Entering Values and Strings."
- Press the SELECT key or the ESC key to close the setting box.

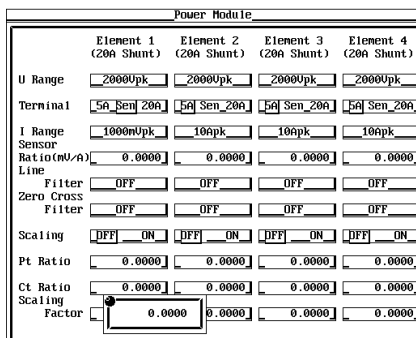

## 5.5 Setting the Scaling Function when using an External PT or CT

### Setting the Scaling Function for All Elements

Sets the scaling function of the power measurement module for all elements at once. This is applicable to products (PZ4000) with firmware version 2.01 or later.

1. Press the INPUT key to display the Input setting menu.
2. Press the [Power Module (All)] soft key to display the All power module setting dialog box.

The menu does not appear for elements without modules. If the sensor input module is installed in the element number 4 slot, the menu for element 4 does not appear.

### Turn ON/OFF the scaling function

3. Turn the jog shuttle to select the [Scaling] of element 1.
4. Press the SELECT key to select [ON] or [OFF]. The [Scaling] of all other modules that are displayed are set to the same value ([ON] or [OFF]).

### Setting the PT ratio

3. Turn the jog shuttle to select the [PT Ratio] of element 1.
4. Press the SELECT key to display the PT ratio setting box.
5. Turn the jog shuttle to set the PT ratio.

For the procedures related to entering values using the jog shuttle, see section 4.1, "Entering Values and Strings."

6. Press the SELECT key or the ESC key to close the setting box. The [PT Ratio] of all other modules that are displayed are set to the same PT ratio.

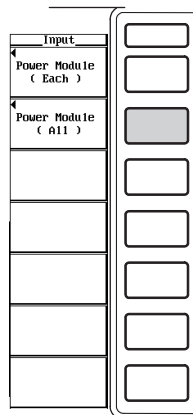

Power Module All				
	Element 1 (Standard)	Element 2 (20A Shunt)	Element 3 (Standard)	Element 4 (Standard)
U Range	20000pk	20000pk	20000pk	20000pk
Terminal	5A Sen	5A Sen 20A	5A Sen	5A Sen
I Range	1000mUpk	1000mUpk	1000mUpk	1000mUpk
Sensor Ratio(mV/A)	10.0000	10.0000	10.0000	10.0000
Line Filter	OFF	OFF	OFF	OFF
Zero Cross Filter	OFF	OFF	OFF	OFF
Scaling	OFF ON	OFF ON	OFF ON	OFF ON
Pt Ratio	1.0000	1.0000	1.0000	1.0000
Ct Ratio	1.0000	1.0000	1.0000	1.0000
Scaling Factor	1.0000	1.0000	1.0000	1.0000

**Setting the CT ratio**

3. Turn the jog shuttle to select the [CT Ratio] of element 1.
4. Press the SELECT key to display the CT ratio setting box.
5. Turn the jog shuttle to set the CT ratio.  
 For the procedures related to entering values using the jog shuttle, see section 4.1, "Entering Values and Strings."
6. Press the SELECT key or the ESC key to close the setting box. The [CT Ratio] of all other modules that are displayed are set to the same CT ratio.

Power Module All				
	Element 1 (Standard)	Element 2 (20A Shunt)	Element 3 (Standard)	Element 4 (Standard)
U Range	2000Upk	2000Upk	2000Upk	2000Upk
Terminal	5A Senj	5A Senj 20A	5A Senj	5A Senj
I Range	1000mUpk	1000mUpk	1000mUpk	1000mUpk
Sensor Ratio (mV/A)	10.0000	10.0000	10.0000	10.0000
Line Filter	OFF	OFF	OFF	OFF
Zero Cross Filter	OFF	OFF	OFF	OFF
Scaling	OFF ON	OFF ON	OFF ON	OFF ON
Pt Ratio	1.0000	1.0000	1.0000	1.0000
Ct Ratio	1.0000	1.0000	1.0000	1.0000
Scaling Factor	1.0000	1.0000	1.0000	1.0000

**Setting the power coefficient**

3. Turn the jog shuttle to select the [Scaling Factor] of element 1.
4. Press the SELECT key to display the power coefficient setting box.
5. Turn the jog shuttle to set the power coefficient.  
 For the procedures related to entering values using the jog shuttle, see section 4.1, "Entering Values and Strings."
6. Press the SELECT key or the ESC key to close the setting box. The [Scaling Factor] of all other modules that are displayed are set to the same power coefficient.

Power Module All				
	Element 1 (Standard)	Element 2 (20A Shunt)	Element 3 (Standard)	Element 4 (Standard)
U Range	2000Upk	2000Upk	2000Upk	2000Upk
Terminal	5A Senj	5A Senj 20A	5A Senj	5A Senj
I Range	1000mUpk	1000mUpk	1000mUpk	1000mUpk
Sensor Ratio (mV/A)	10.0000	10.0000	10.0000	10.0000
Line Filter	OFF	OFF	OFF	OFF
Zero Cross Filter	OFF	OFF	OFF	OFF
Scaling	OFF ON	OFF ON	OFF ON	OFF ON
Pt Ratio	1.0000	1.0000	1.0000	1.0000
Ct Ratio	1.0000	1.0000	1.0000	1.0000
Scaling Factor	1.0000	1.0000	1.0000	1.0000

## 5.5 Setting the Scaling Function when using an External PT or CT

---

### Explanation

Measurements can be made by connecting the output of the secondary side of the PT and the output of the secondary side of the CT to the same voltage and current input terminals that are used when directly inputting a signal.

#### Turning ON/OFF the scaling function

You can select whether or not to multiply the voltage U, current I, and power (P, S, Q) by the PT ratio, CT ratio, and power coefficient respectively.

- ON : The voltage U, current I, and power (P, S, Q) are multiplied by the PT ratio, CT ratio, and power coefficient.
- OFF : The voltage U, current I, and power (P, S, Q) are not multiplied by the PT ratio, CT ratio, and power coefficient. The output values of the external PT and CT are read directly as numerical data in this case.

#### Setting the PT ratio

Set the ratio in the range from 0.0001 to 99999.9999.

#### Setting the CT ratio

Set the ratio in the range from 0.0001 to 99999.9999.

#### Setting the power coefficient (scaling factor)

Set the power factor in the range from 0.0001 to 99999.9999.

#### Note

---

- If the result of multiplying the PT ratio, CT ratio, or power coefficient (scaling factor) to the measurement range exceeds 99999M, the display frame of the numerical data will display [-OF-].
  - As described later in waveform computation (see section 11.2), the power coefficient (scaling factor) is not applied when computing the product of the voltage and current (C1\*C2, for example).
  - The specified PT ratio, CT ratio, and power coefficient take effect when the data acquisition is started or when numerical computation is executed.
-

## 5.6 Selecting the Input Filter

«For a functional description, see section 1.3.»

### Keys

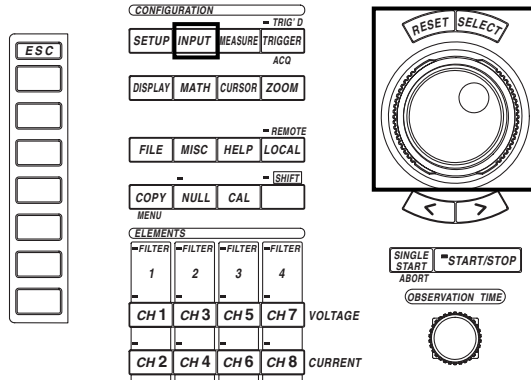

- The  mark indicates the keys that are used for the operation.
- To exit the menu during operation, press the ESC key.

### Procedure

#### Selecting the Input Filter for Each Element

Selects the input filter of the power measurement module for each element.

1. Press the INPUT key to display the Input setting menu.  
On products (PZ4000) with firmware version before 2.01, only the [Power Module] soft key appears.
2. Press the [Power Module (Each)] soft key to display the power module setting dialog box.  
The menu does not appear for elements without modules. If the sensor input module is installed in the element number 4 slot, the menu for element 4 does not appear.

#### Selecting the line filter

3. Turn the jog shuttle to select the [Line Filter] of the element you wish to set.
4. Press the SELECT key to display the line filter selection box.
5. Turn the jog shuttle to select the filter from [OFF] to [500Hz].
6. Press the SELECT key to confirm the line filter. The FILTER indicator in the ELEMENT group on the front panel lights.

#### Selecting the zero crossing filter

3. Turn the jog shuttle to select the [Zero Crossing Filter] of the element you wish to set.
4. Press the SELECT key to display the zero crossing filter selection box.
5. Turn the jog shuttle to select the filter from [OFF] to [500Hz].
6. Press the SELECT key to confirm the zero crossing filter.

## 5.6 Selecting the Input Filter

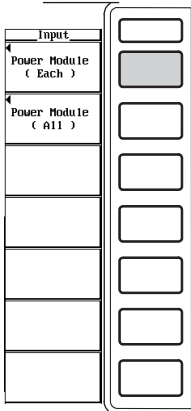

Power Module				
	Element 1 (20A Shunt)	Element 2 (20A Shunt)	Element 3 (20A Shunt)	Element 4 (20A Shunt)
U Range	2000Upk	2000Upk	2000Upk	2000Upk
Terminal	5A Sen 20A	5A Sen 20A	5A Sen 20A	5A Sen 20A
I Range	1000mUpk	100pk	100pk	100pk
Sensor Ratio(mV/A)	0.0000	0.0000	0.0000	0.0000
Line Filter	OFF	<b>•Select</b>	OFF	OFF
Zero Cross Filter	OFF	OFF	OFF	OFF
Scaling	OFF ON	500Hz	OFF ON	OFF ON
Pt Ratio	0.0000	20kHz	0.0000	0.0000
Ct Ratio	0.0000	1MHz	0.0000	0.0000
Scaling Factor	0.0000		0.0000	0.0000

Power Module				
	Element 1 (20A Shunt)	Element 2 (20A Shunt)	Element 3 (20A Shunt)	Element 4 (20A Shunt)
U Range	2000Upk	2000Upk	2000Upk	2000Upk
Terminal	5A Sen 20A	5A Sen 20A	5A Sen 20A	5A Sen 20A
I Range	1000mUpk	100pk	100pk	100pk
Sensor Ratio(mV/A)	0.0000	0.0000	0.0000	0.0000
Line Filter	OFF	<b>•Select</b>	OFF	OFF
Zero Cross Filter	OFF	OFF	OFF	OFF
Scaling	OFF ON	OFF	OFF ON	OFF ON
Pt Ratio	0.0000	500Hz	0.0000	0.0000
Ct Ratio	0.0000	20kHz	0.0000	0.0000
Scaling Factor	0.0000		0.0000	0.0000

### Selecting the Input Filter for All Elements

Selects the input filter of the power measurement module for all elements at once. This is applicable to products (PZ4000) with firmware version 2.01 or later.

1. Press the INPUT key to display the Input setting menu.
2. Press the [Power Module (All)] soft key to display the All power module setting dialog box.

The menu does not appear for elements without modules. If the sensor input module is installed in the element number 4 slot, the menu for element 4 does not appear.

### Selecting the line filter

3. Turn the jog shuttle to select the [Line Filter] of element 1.
4. Press the SELECT key to display the line filter selection box.
5. Turn the jog shuttle to select the filter from [OFF] to [1MHz].
6. Press the SELECT key to confirm the line filter. The [Line Filter] of all other modules that are displayed are set to the same line filter. The FILTER indicator in the ELEMENT group on the front panel lights.

### Selecting the zero crossing filter

3. Turn the jog shuttle to select the [Zero Crossing Filter] of the element you wish to set.
4. Press the SELECT key to display the zero crossing filter selection box.
5. Turn the jog shuttle to select the filter from [OFF] to [20kHz].
6. Press the SELECT key to confirm the zero crossing filter. The [Zero Cross Filter] of all other modules that are displayed are set to the same zero crossing filter.

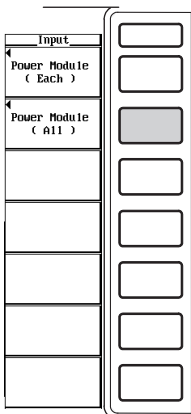

Power Module All				
	Element 1 (Standard)	Element 2 (20A Shunt)	Element 3 (Standard)	Element 4 (Standard)
U Range	2000Upk	2000Upk	2000Upk	2000Upk
Terminal	5A Sen	5A Sen 20A	5A Sen	5A Sen
I Range	1000mUpk	1000mUpk	1000mUpk	1000mUpk
Sensor Ratio(mV/A)	10.0000	10.0000	10.0000	10.0000
Line Filter	OFF	<b>•Select</b>	OFF	OFF
Zero Cross Filter	OFF	OFF	OFF	OFF
Scaling	OFF ON	500Hz	OFF ON	OFF ON
Pt Ratio	1.0000	20kHz	1.0000	1.0000
Ct Ratio	1.0000	1MHz	1.0000	1.0000
Scaling Factor	1.0000		1.0000	1.0000

Power Module All				
	Element 1 (Standard)	Element 2 (20A Shunt)	Element 3 (Standard)	Element 4 (Standard)
U Range	2000Upk	2000Upk	2000Upk	2000Upk
Terminal	5A Sen	5A Sen 20A	5A Sen	5A Sen
I Range	1000mUpk	1000mUpk	1000mUpk	1000mUpk
Sensor Ratio(mV/A)	10.0000	10.0000	10.0000	10.0000
Line Filter	OFF	<b>•Select</b>	OFF	OFF
Zero Cross Filter	OFF	OFF	OFF	OFF
Scaling	OFF ON	OFF	OFF ON	OFF ON
Pt Ratio	1.0000	500Hz	1.0000	1.0000
Ct Ratio	1.0000	20kHz	1.0000	1.0000
Scaling Factor	1.0000		1.0000	1.0000

**Explanation**

The following two types of filters are available on the power measurement module. For selecting the input filter of the motor module, see section 15.3.

**Selecting the line filter**

The line filter is inserted into the circuit under measurement. It removes the noise from the inverter and from distorted waveforms. The cutoff frequency can be selected from the following choices. Selecting OFF disables the filter.

OFF, 500 Hz, 20 kHz, 1 MHz

**Selecting the zero crossing filter**

This filter is inserted only into the frequency measurement circuit. Zero crossing refers to the input signal crossing the center value of the amplitude of the input signal. This filter is used to accurately detect the zero crossing point. This instrument detects the zero crossing point with a hysteresis of approximately 3.5% of the measurement range. The cutoff frequency can be selected from the following choices. When the zero crossing filter is OFF and the line filter (above) is ON, the cutoff frequency specified by the line filter is used as a zero crossing filter.

OFF, 500 Hz, 20 kHz

# 6.1 Setting the Observation Time

«For a functional description, see section 1.3.»

## Keys

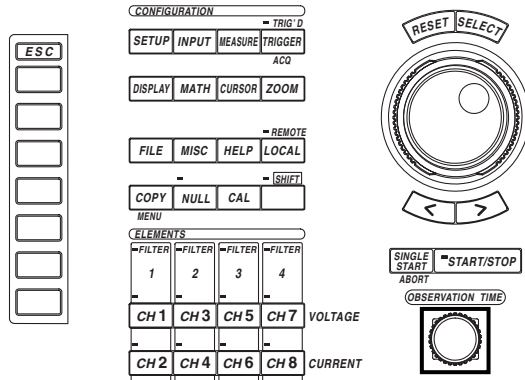

- The  mark indicates the keys that are used for the operation.
- To exit the menu during operation, press the ESC key.

## Procedure

### During the normal measurement mode

Turn the OBSERVATION TIME rotary knob. The selected observation time is displayed in the top right corner of the screen.

### During the harmonic measurement mode

The observation time is automatically determined by the sampling rate, which can be determined from the fundamental frequency and the record length.



## 6.1 Setting the Observation Time

### Explanation

The observation time represents the time span of one screen. How the observation time is determined depends on the measurement mode.

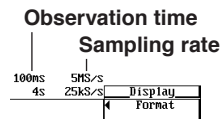

### During the normal measurement mode

The selectable range is from 10  $\mu$ s to 1 ks\* (in 1-2-4 steps).

The sampling rate changes depending on the observation time. The sampling rate is used to acquire the data to the acquisition memory. For details regarding the observation time, sampling rate, and record length, see Appendix 1.

\* 1 ks denotes 1000 s (16 minutes 40 seconds).

### During the harmonic measurement mode

The observation time for the harmonic measurement mode is automatically determined from the sampling rate that is determined from the fundamental frequency of the PLL source (see section 6.4) and the record length (see section 1.3). The observation time is not displayed. The observation times when the record length is not divided (see section 6.4) are shown below.

- When the record length is 100 k-words : Approx. 0.5 to 1.6 s
- When the record length is 1 M-word : Approx. 4.9 to 16.3 s
- When the record length is 4 M-word : Approx. 19.5 to 65.1 s

For details regarding the observation time, sampling rate, and record length, see Appendix 1.

### Note

- During the normal measurement mode, the observation time can be changed even when the data acquisition is stopped. The new observation time takes effect when the data acquisition is started.

#### Observation time of the displayed data

#### Observation time that has been changed

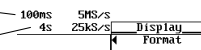

- When the time base (see section 6.3) is set to external clock, the record length of data is acquired by sampling at the rate of the external clock. In this case, the observation time is not displayed.
- For the harmonic measurement mode, the sampling rate depends on an external signal referred to as the PLL source (signal under measurement or external clock signal) and therefore, the observation time cannot be set uniformly as in the normal measurement mode. In the harmonic measurement mode, the time it takes to store the record length of sampled data in the acquisition memory is the time displayed on one screen.

## 6.2 Selecting the Record Length for Acquiring Data

«For a functional description, see section 1.3.»

### Keys

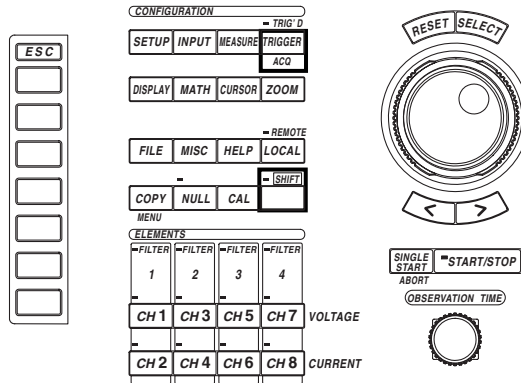

- The  mark indicates the keys that are used for the operation.
- To exit the menu during operation, press the ESC key.

### Procedure

1. Press the SHIFT+TRIGGER(ACQ) key to display the Acq setting menu.

#### Selecting the record length

When the optional memory extension is being used, the record length can be selected.

2. Press the [Record Length] soft key to display the record length selection menu.
3. Press one of the keys from [100k] to [4M] to select the record length.

#### Select whether or not to divide the record length

2. Press the [Rec Division] soft key to select [ON] or [OFF].

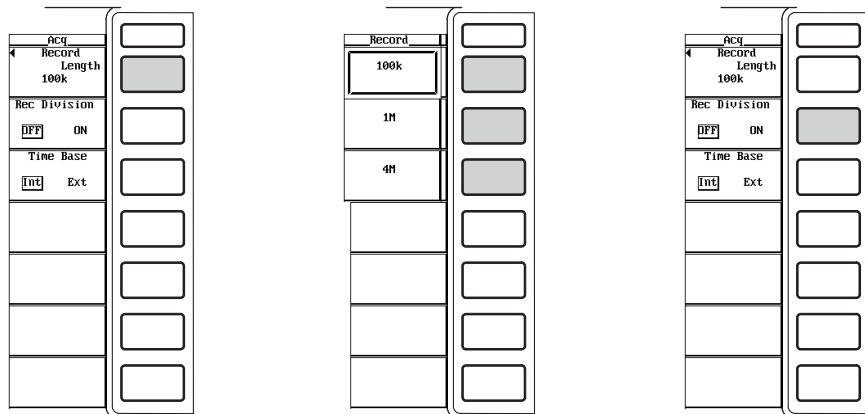

### Explanation

#### Selecting the record length

On this instrument, the record length refers to the data capacity of the acquisition memory per channel. It can be selected from the following choices. 1 M and 4 M are memory extension options.

100 k, 1 M, 4 M

The sampled data in the acquisition memory are P-P compressed and displayed. The number of data points displayed on the screen is referred to as the display record length. The numerical data are determined based on the sampled data within this display record length. For details regarding the observation time, sampling rate, and record length, see Appendix 1.

For the normal measurement mode, the size of the display record length varies depending on the observation time setting and the maximum size is equal to the record length. When the observation time is long, the record length and display record length are the same, but when the observation time is short, the display record length becomes shorter than the record length.

When the time base is set to external clock or when the measurement mode is harmonic, the display record length and record length are always equal.

#### Note

---

When the time base (see section 6.3) is set to external clock, the record length of data is acquired by sampling at the rate of the external clock.

---

#### Dividing the record length

You can select whether or not to divide the acquisition memory in half.

- ON : Divide the memory so that it appears as though there are two memories. The data can be acquired to each memory separately. The record length of each memory is half the total record length.
- OFF : Do not divide the memory.

## 6.3 Selecting the Time Base

«For a functional description, see section 1.3.»

### Keys

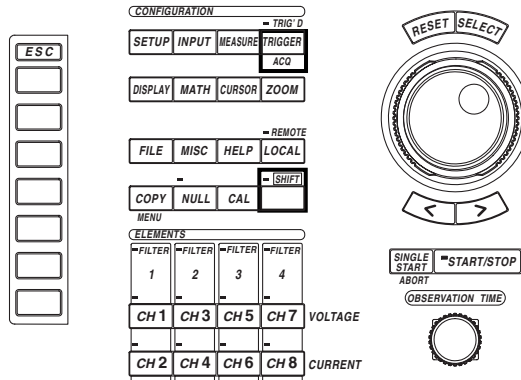

- The   mark indicates the keys that are used for the operation.
- To exit the menu during operation, press the ESC key.

### Procedure

1. Press the SHIFT+TRIGGER(ACQ) key to display the Acq setting menu.
2. Press the [Time Base] soft key to select [Int] or [Ext].

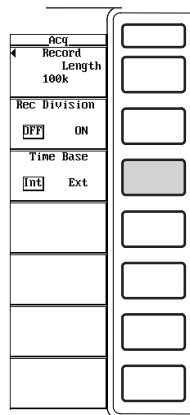

### Explanation

With the default setting of the instrument, the data sampling timing is controlled by the clock signal that is generated by the internal time base circuit. This setting can be changed so that the timing is controlled by an external clock signal.

#### Selecting the time base

Select the time base from the following choices.

- Int : The internal clock signal becomes the time base. The observation time that was set in section 6.1 becomes effective.
- Ext : The clock signal applied to the external clock input connector becomes the time base. The observation time that was set in section 6.1 becomes ineffective.

### 6.3 Selecting the Time Base

#### When the time base is set to [Ext]

Apply a clock signal to the external clock input connector (EXT CLK IN) on the rear panel that meets the following specifications.



Item	Specification
Connector type	BNC connector
Frequency range	1 kHz to 250 kHz
Input level	CMOS
Minimum pulse width	1 $\mu$ s for both High and Low



#### CAUTION

Applying a signal to the external clock input connector (EXT CLK IN) that is outside the 0 to 5 V range may damage the instrument.

#### Circuit diagram and timing chart of the external clock input

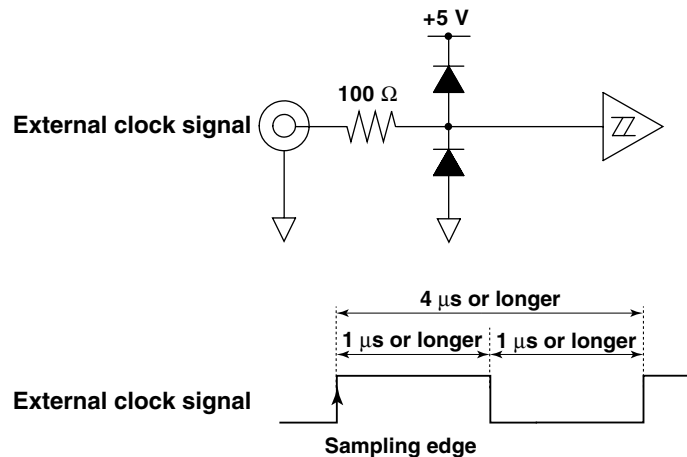

#### Note

- The external clock must be a continuous clock. Burst signals cannot be used.
- There is no function available to frequency divide the external clock signal on this instrument.
- If the time base is set to external clock, the observation time cannot be changed. If you wish to change the displayed range of the time axis, change the record length or zoom horizontally.
- If the time base is set to external clock, the time measured using the cursor is in terms of clock counts of the clock signal. No units are displayed.
- If the time base is set to external clock, the trigger delay setting is void.
- If the time base is set to external clock, the TINTG function for waveform computation (see section 11.2) computes sampling data as one second data.
- The external clock signal is used for the following purposes in addition to providing data sampling timing.
  - PLL source (see section 6.4)
  - Measurement/Computation period setting (see section 10.1)
- In order to measure the harmonics of higher orders more accurately, the input signal must be sampled using a clock signal that has a frequency that is an integer multiple of the fundamental frequency of the input signal. The instrument generates the clock signal from the input signal that is selected as the PLL source and samples the input signal. By setting the time base to external clock and applying a clock signal to the external clock input connector that has a frequency that is 4096 times the fundamental frequency of the input signal, the harmonics of higher orders can be measured more accurately.
- When acquiring sampled data with the time base set to external clock and a clock with a frequency outside the specifications or the clock is not input, the acquisition of the sampled data may not operate properly. In some cases, this may corrupt the normal sampled data acquired the previous time to the partitioned acquisition memory.

## 6.4 Selecting the PLL Source for Harmonic Measurement

«For a functional description, see section 1.2.»

The following section applies when the measurement mode is set to harmonic measurement.

### Keys

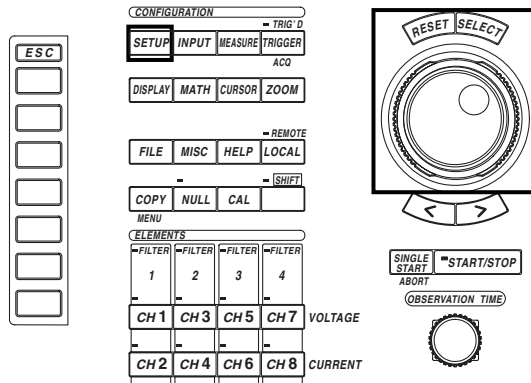

- The  mark indicates the keys that are used for the operation.
- To exit the menu during operation, press the ESC key.

### Procedure

Set the measurement mode to harmonic measurement. For the procedures, see section 5.1, “Selecting the Measurement Mode.”

1. Press the SETUP key to display the Setup menu. Confirm that [Mode] is set to [Harmonics].
2. Press the [PLL Source] soft key to display the PLL source selection box.
3. Turn the jog shuttle to select the PLL source from [CH1] to [Ext Clk].
4. Press the SELECT key to confirm the new PLL source.

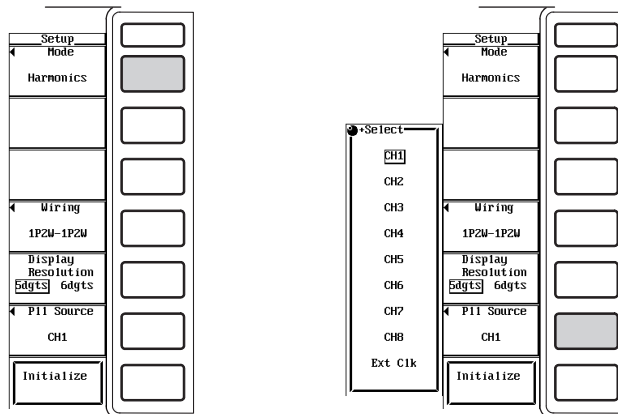

## 6.4 Selecting the PLL Source for Harmonic Measurement

### Explanation

Select the PLL source (phase locked loop source) to be used for determining the fundamental frequency for the analysis of the harmonics.

#### Selecting the PLL source

Select the PLL source from the following choices.

- CH1 to CH8 : The voltage or current of the element that has a measurement module installed becomes the PLL source. The numbers of the channels that do not have measurement modules installed are not displayed.
- Ext Clk : The clock signal applied to the external clock input connector becomes the PLL source.

#### When setting the PLL source to [Ext Clk]

Apply a clock signal to the external clock input connector (EXT CLK IN) on the rear panel that meets the following specifications.



Item	Specification
Connector type	BNC connector
Frequency range	20 Hz to 6.4 kHz
Input level	CMOS



### CAUTION

Applying a signal to the external clock input connector (EXT CLK IN) that is outside the 0 to 5 V range may damage the instrument.

#### Note

- Specify a signal that has the same period as the signal being measured. Selecting a signal with little distortion for the PLL source will result in a stable harmonic measurement. If the fundamental frequency of the PLL source cannot be determined due to fluctuations and distortion of the signal, correct measurement results cannot be obtained. It is recommended that the PLL source be set to a voltage that has little distortion as compared to the current. There are cases when the specifications cannot be satisfied if all input signals are distorted or their amplitudes are small with respect to the measurement range. In order to measure the harmonics of higher orders more accurately, set the PLL source to external clock and apply a signal to the external clock input connector that has the same period as the input signal.
- If the fundamental frequency is less than or equal to 500 Hz and the signal contains high frequency components, we recommend the zero crossing filter be set to [500 Hz]. This filter has a cut-off frequency of 500 Hz and is effective only for the frequency measurement circuit.
- When the amplitude of the signal selected for the PLL source (CH1 to CH8) is small compared to the range, PLL synchronization may fail. In this case, set the measurement range so that the amplitude of the PLL source signal is larger than 30% of the range rating.
- The harmonics of higher orders can be measured more accurately by using an external clock signal that has a frequency that is an integer multiple of the fundamental frequency of the signal being measured.
- The external clock must be a continuous clock. Burst signals cannot be used.
- There is no function available to frequency divide the external clock signal on this instrument.
- When acquiring sampled data with the time base set to external clock and the frequency of the PLL source is lost (cannot be detected), the acquisition of the sampled data may not operate properly.

# 7.1 Selecting the Trigger Mode

«For a functional description, see section 1.4.»

## Keys

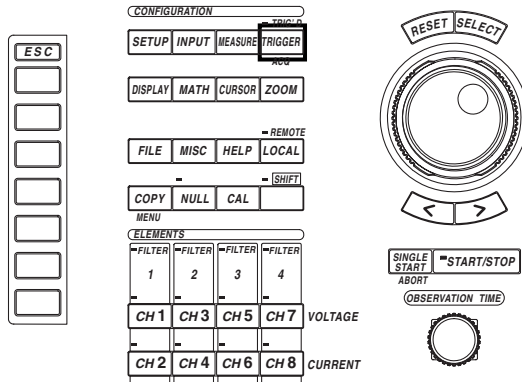

- The  mark indicates the keys that are used for the operation.
- To exit the menu during operation, press the ESC key.

## Procedure

1. Press the TRIGGER key to display the Trigger setting menu.
2. Press the [Mode] soft key to display the trigger mode selection menu.
3. Press one of the keys from [OFF] to [HF Normal] to select the trigger mode.

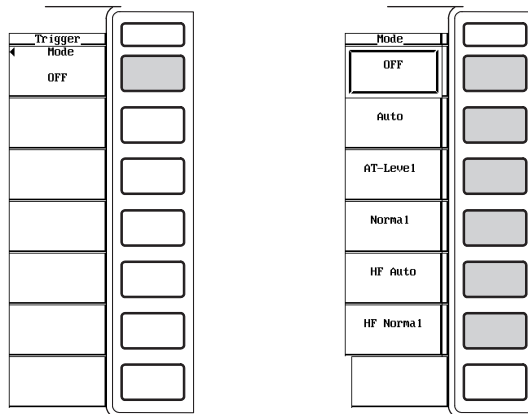



## 7.1 Selecting the Trigger Mode

---

### Explanation

The trigger mode is used to set the conditions for updating the display. Select the trigger mode from the following choices.

- **OFF** : Sets the trigger mode to OFF.  
The display is updated regardless of whether or not the trigger conditions are met. When set to OFF, the other menus in the Trigger setting menu are not displayed.
- **Auto** : Sets the trigger mode to auto.
  - The waveform is updated when a trigger occurs within the timeout period (approx. 100 ms).
  - If the trigger does not occur within the timeout period, the waveform display is automatically updated when the timeout period elapses.When the period of the trigger signal is greater than 100 ms, the above two conditions are met alternately and the display is updated. In this case, set the mode to normal.
- **AT-Level** : Sets the trigger mode to auto-level mode.
  - If a trigger occurs within the timeout period, the waveform is displayed in the same way as in the auto mode.
  - If a trigger does not occur within the timeout period, the center value of the amplitude of the trigger source is detected, the trigger level is automatically changed to the center value, and the trigger (edge trigger) is generated to update the displayed waveform.
- **Normal** : Sets the trigger mode to normal mode.
  - The display is updated when a trigger occurs.
  - If a trigger does not occur, the display is not updated.
- **HF Auto** : Sets the trigger mode to HF auto.
  - The output of the zero crossing detector of the trigger source is used to detect the trigger condition. Because the trigger occurs when the trigger source crosses the center level of the amplitude of the trigger source (with a hysteresis of approx. 3.5% of the measurement range) and the display is updated, the trigger level setting (see section 7.3) is void.
  - The behavior with respect to the timeout period is the same as in the auto mode.
  - When the zero crossing filter is set, the trigger becomes less susceptible to harmonic noise and unexpected triggers are prevented from occurring.
  - The PZ4000 may not operate properly when the motor module is installed in the element number 4 slot and the trigger source is set to CH7 or CH8.
- **HF Normal** : Sets the trigger mode to HF normal.
  - The method in which the trigger is activated is the same as in the HF auto mode.
  - The behavior with respect to the timeout period is the same as in the normal mode.
  - The PZ4000 may not operate properly when the motor module is installed in the element number 4 slot and the trigger source is set to CH7 or CH8.

### Note

- When the trigger mode is [AT-Level], edge trigger is the only trigger type available.
  - When the trigger mode is [HF Auto] or [HF Normal], edge trigger is the only trigger type available. In addition, the trigger level cannot be set.
-

## 7.2 Selecting the Trigger Source

«For a functional description, see section 1.4.»

This section applies when the trigger mode is set to a mode other than OFF.

### Keys

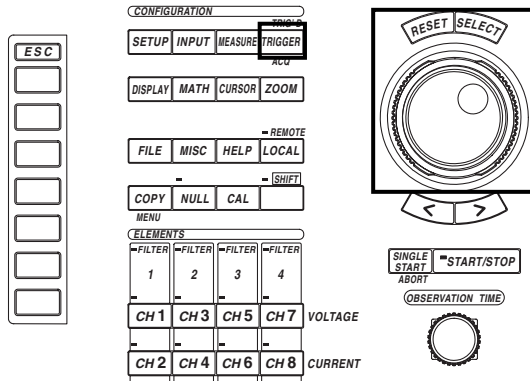

- The  mark indicates the keys that are used for the operation.
- To exit the menu during operation, press the ESC key.

### Procedure

Set the trigger mode to a mode other than OFF. For procedures, see section 7.1, “Selecting the Trigger Mode.”

1. Press the TRIGGER key to display the Trigger setting menu. Check that [Mode] is set to a mode other than [OFF].
2. Press the [Source] soft key to display the source selection box.
3. Turn the jog shuttle to select the source from [CH1] to [Ext].
4. Press the SELECT key to confirm the new source.

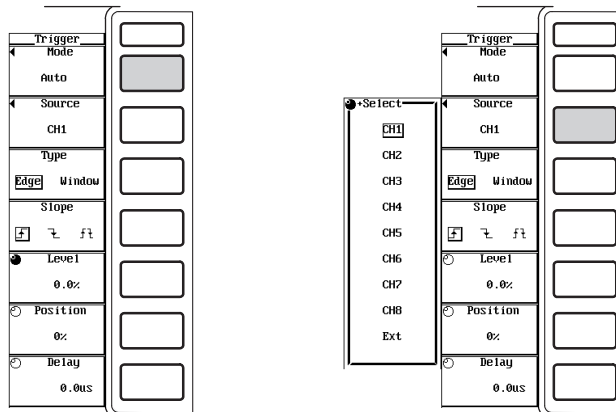

## 7.2 Selecting the Trigger Source

### Explanation

#### Selecting the trigger source

Select the signal that is used for triggering (trigger source). Select from the following choices.

- CH1 to CH8 : The trigger source is set to the voltage or current of the element that has a measurement module installed. The numbers of the channels that do not have measurement modules installed are not displayed.
- Ext : The trigger source is set to the signal that is applied to the external trigger input connector. Edge trigger (see section 7.3) is the only trigger type that is valid. The trigger level setting (see section 7.3) is void.

#### When the trigger source is set to [Ext]

Apply a signal to the external clock input connector (EXT TRIG IN) on the rear panel that meets the following specifications



Item	Specification
Connector type	BNC connector
Input level	CMOS
Minimum pulse width	1 $\mu$ s
Trigger delay time	Within (1 $\mu$ s + 1 sample period)



### CAUTION

Applying a signal to the external trigger input connector (EXT TRIG IN) that is outside the 0 to 5 V range may damage the instrument.

#### Circuit diagram and timing chart of the external trigger input

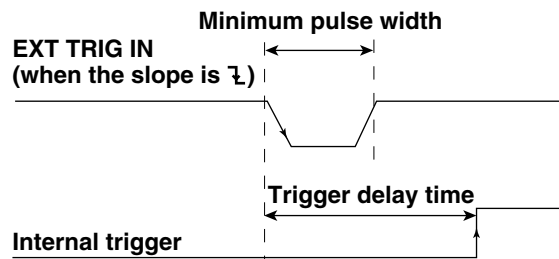
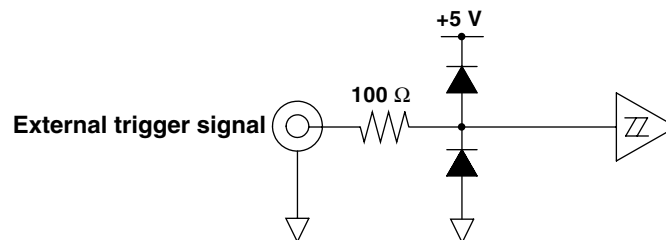

**Note**

Two PZ4000s can be synchronized using the external trigger output function. For details, see 14.1 “External Trigger Output.”

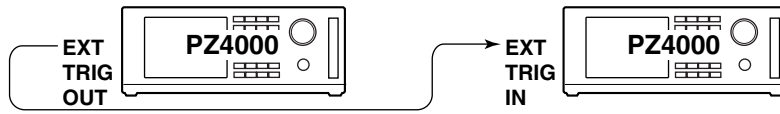

## 7.3 Setting the Edge Trigger

«For a functional description, see section 1.4.»

This section applies when the trigger mode is set to a mode other than OFF.

### Keys

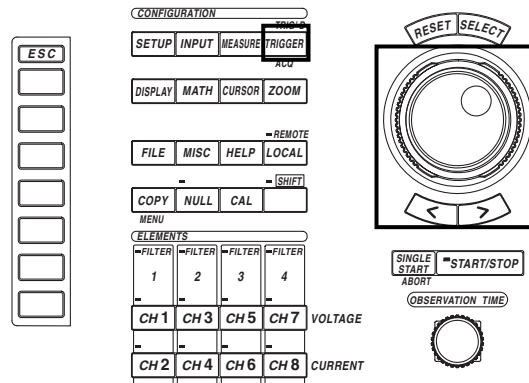

- The  mark indicates the keys that are used for the operation.
- To exit the menu during operation, press the ESC key.

### Procedure

**Set the trigger mode to a mode other than OFF. For procedures, see section 7.1, “Selecting the Trigger Mode.”**

1. Press the TRIGGER key to display the Trigger setting menu. Check that [Mode] is set to something other than [OFF].

#### Selecting the trigger type

2. Press the [Type] soft key to select [Edge] to set the trigger type to edge trigger.

#### Selecting the trigger slope

3. Press the [Slope] soft key to select [ $f$ ], [ $\nabla$ ], or [ $f \nabla$ ].

#### Setting the trigger level

4. Press the [Level] soft key.
5. Turn the jog shuttle to set the trigger level.

For the procedures related to entering values using the jog shuttle, see section, 4.1 “Entering Values and Strings.”

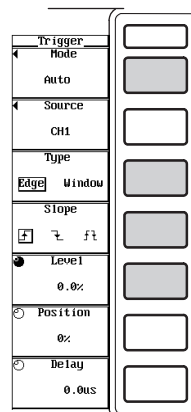

**Explanation****Selecting the trigger type**

Select the trigger type from the following choices. Here, select [Edge].

- Edge : Sets the trigger type to edge trigger. A trigger occurs when the trigger source rises above or falls below a preset trigger level.
- Window : Sets the trigger type to window trigger. A certain window (width) is set and a trigger occurs when the trigger source level enters this window (IN) or exits from this window (OUT). For window trigger, see section, 7.4 “Setting the Window Trigger.”

**Selecting the trigger slope**

Slope refers to the movement of the signal such as the movement from a low level to a high level (rising) or the movement from a high level to a low level (falling). When the slope is used as one of the trigger conditions, it is called a trigger slope. Select the trigger slope from the following choices.

- $\nearrow$  : The trigger occurs when the trigger source signal rises above the trigger level from a lower level.
- $\searrow$  : The trigger occurs when the trigger source signal falls below the trigger level from a higher level.
- $\leftrightarrow$  : The trigger occurs on both the rising and falling cases.

**Setting the trigger level**

Trigger level refers to the level that is used to judge the passing level of the trigger slope or the condition of the trigger source. When the trigger type is set to [Edge], you specify the passing level of the trigger slope with the trigger level.

Set the level in the range from 0.0 to  $\pm 100.0\%$ .

Half of the total vertical span of the waveform display screen is considered to be 100%. With the center of the vertical axis taken to be the zero amplitude line, the upper and lower limits of the screen are 100% and  $-100\%$ , respectively.

The upper and lower limits of the display screen correspond to the measurement range (if scaled, the range after scaling) of the voltage/current that is set for each channel.

- Measurement range : 300 Vpk
- Trigger level : 25%

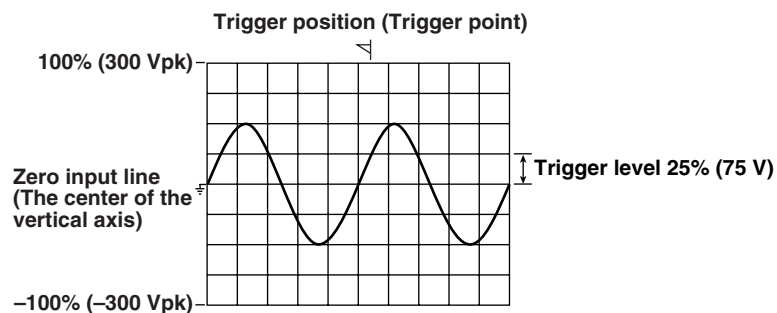
**Note**

- The trigger level setting is void when the trigger mode is [OFF], [HF Auto], or [HF Normal]. It is also void when the trigger mode is [AT-Level] and the trigger does not occur within the timeout period.
- The trigger level setting is void when the trigger source is set to [Ext].
- When the trigger mode is [HF Auto] or [HF Normal], the trigger level cannot be set.

## 7.4 Setting the Window Trigger

«For a functional description, see section 1.4.»

This section applies when the trigger mode is set to a mode other than OFF.

### Keys

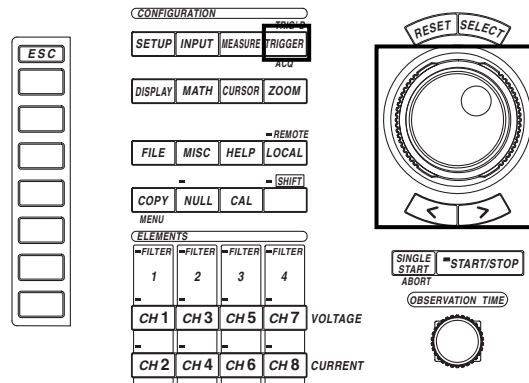

- The  mark indicates the keys that are used for the operation.
- To exit the menu during operation, press the ESC key.

### Procedure

Set the trigger mode to a mode other than OFF. For procedures, see section 7.1, “Selecting the Trigger Mode.”

1. Press the TRIGGER key to display the Trigger setting menu. Check that [Mode] is set to something other than [OFF].

#### Setting the trigger type

2. Press the [Type] soft key to select [Window] and set the trigger type to window trigger.

#### Selecting the trigger source condition.

3. Press the [Condition] soft key to select [In] or [Out].

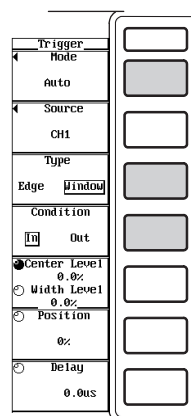

### Setting the window

- **Setting the center level**

4. Press the [Center Level / Width Level] soft key to select [Center Level].
5. Turn the jog shuttle to set the center level.

For the procedures related to entering values using the jog shuttle, see section 4.1, “Entering Values and Strings.”

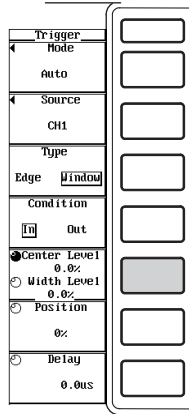

- **Setting the window width**

6. Press the [Center Level / Width Level] soft key to select [Width Level].
7. Turn the jog shuttle to set the window width.

For the procedures related to entering values using the jog shuttle, see section 4.1, “Entering Values and Strings.”

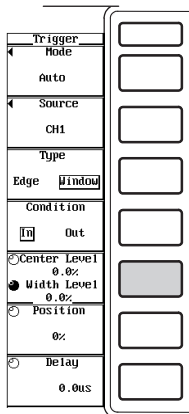



### Explanation

#### Selecting the trigger type

Select the trigger type from the following choices. Here, select [Window].

- Edge : Sets the trigger type to edge trigger. A trigger occurs when the trigger source rises above or falls below a preset trigger level. For edge trigger, see section 7.3, “Setting the Edge Trigger.”
- Window : Sets the trigger type to window trigger. A certain window (width) is set and a trigger occurs when the trigger source level enters this window (IN) or exits from this window (OUT).

#### Selecting the trigger source condition

Select the trigger source condition, used to activate the trigger, from the following choices.

- In : The trigger occurs when the trigger source signal enters the specified window width.
- Out : The trigger occurs when the trigger source signal leaves the specified window width.

#### Setting the window

The window is set by specifying the center level (Center Level) and the window width (Width Level) with respect to the center level.

- **Setting the center level**

Set the level in the range from 0.0 to  $\pm 100.0\%$ . Half of the total vertical span of the waveform display screen is considered to be 100%. For details, see “Setting the trigger level” on page 7-7.

- **Setting the window width**

Set the level in the range from 0.0 to 200% with respect to the center level described above. Half of the total vertical span of the waveform display screen is considered to be 100%.

- **Measurement range : 300 Vpk**
- **Trigger source condition : In**
- **Center level : 25%**
- **Window width : 100%**

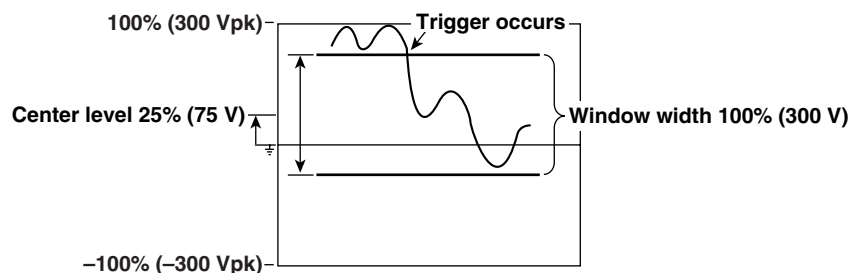

#### Note

- The window trigger setting is void when the trigger mode is set to [OFF], [HF Auto], or [HF Normal]. In addition, the window trigger is not selectable when the trigger mode is set to [AT-Level].
- The trigger level setting is void when the trigger source is set to [Ext].
- When the specified window width exceeds the display range of the screen, the window width is set to the display range.

# 7.5 Setting the Trigger Position

«For a functional description, see section 1.4.»

This section applies when the trigger mode is set to a mode other than OFF.

## Keys

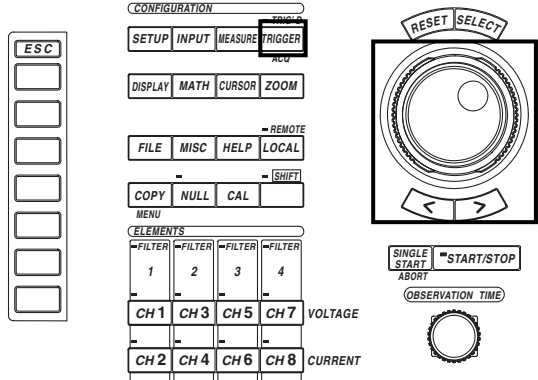

- The  mark indicates the keys that are used for the operation.
- To exit the menu during operation, press the ESC key.

## Procedure

**Set the trigger mode to a mode other than OFF. For procedures, see section 7.1, “Selecting the Trigger Mode.”**

1. Press the TRIGGER key to display the Trigger setting menu. Check that [Mode] is set to something other than [OFF].
2. Press the [Position] soft key.
3. Turn the jog shuttle to set the trigger position.  
For the procedures related to entering values using the jog shuttle, see section 4.1, “Entering Values and Strings.”

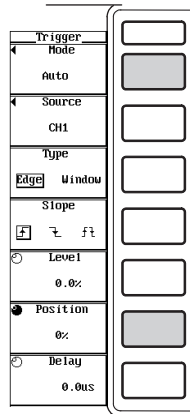

## 7.5 Setting the Trigger Position

---

### Explanation

The trigger position is used to set which section of the sampled data in the acquisition memory to display on the screen.

#### Setting the trigger position

Set the trigger position in the range from 0 to 100%. The left end of the screen is 0%; the right end of the screen is 100%.

When the trigger delay (described in the next section) is 0 s, the trigger point and trigger position match.

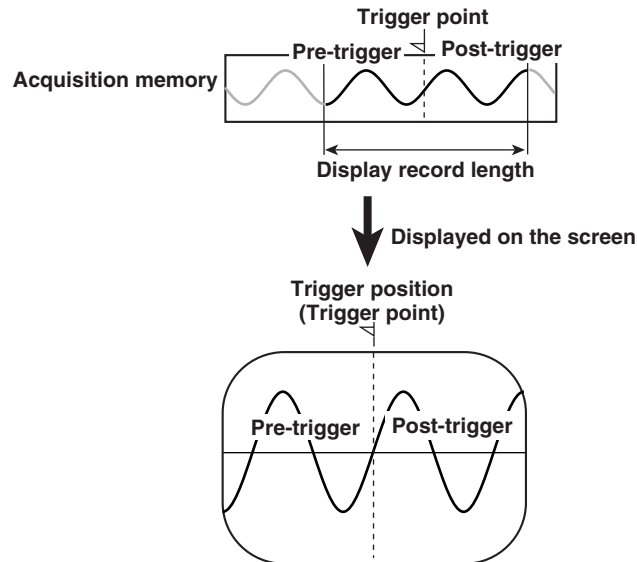

#### Note

- The trigger position can be changed even when the data acquisition is stopped. The new trigger position takes effect when the data acquisition is started.
  - If the observation time is changed, the display range centers itself around the trigger position.
-

## 7.6 Setting the Trigger Delay

«For a functional description, see section 1.4.»

This section applies when the trigger mode is set to a mode other than OFF.

### Keys

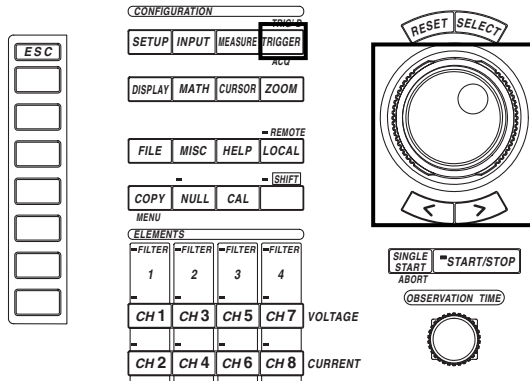

- The  mark indicates the keys that are used for the operation.
- To exit the menu during operation, press the ESC key.

### Procedure

**Set the trigger mode to a mode other than OFF. For procedures, see section 7.1, “Selecting the Trigger Mode.”**

1. Press the TRIGGER key to display the Trigger setting menu. Check that [Mode] is set to something other than [OFF].
2. Press the [Delay] soft key.
3. Turn the jog shuttle to set the trigger delay.  
For the procedures related to entering values using the jog shuttle, see section 4.1, “Entering Values and Strings.”

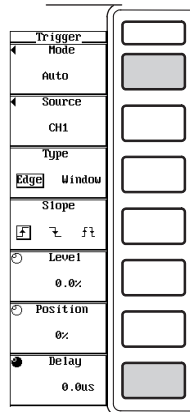

## 7.6 Setting the Trigger Delay

---

### Explanation

The trigger position matches the trigger point when the trigger delay is set to 0 s. This function allows you to display the waveform that is acquired the specified amount of time after the trigger point (delay time).

### Setting the trigger delay

Set the trigger delay in the range from 0.0 to 1000000.0  $\mu\text{s}$  (with 0.5  $\mu\text{s}$  resolution).

When a trigger delay is set

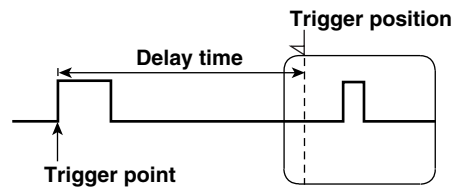

### Note

The trigger delay setting is retained even if the observation time is changed.

---

# 8.1 Selecting the Number of Displayed Digits

«For a functional description, see section 1.2.»

## Keys

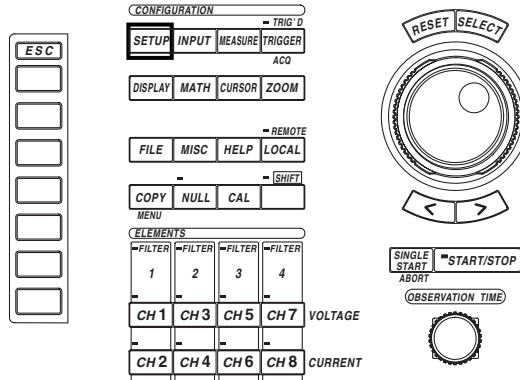

- The  mark indicates the keys that are used for the operation.
- To exit the menu during operation, press the ESC key.

## Procedure

1. Press the SETUP key to display the Setup menu.
2. Press the [Display Resolution] soft key to select [5dgts] or [6dgts].

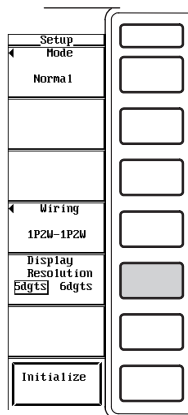

## Explanation

The maximum number of displayed digits (highest display resolution) for the various items such as voltage, current, active power, apparent power, reactive power, and power factor can be selected.

- 5dgts : Display resolution of 99999
- 6dgts : Display resolution of 999999

### Note

- The actual number of displayed digits may sometimes be smaller than the specified number depending on the combinations of the voltage and current ranges or the carry-over operation.
- The highest display resolution for frequency, phase difference (phase angle), cursor measurement, and pk is as follows, regardless of the number of displayed digits that is selected.
  - Frequency : 99999
  - Phase difference (phase angle) : 360.00
  - Cursor measurement : 99999
  - pk : 99999

## 8.2 Displaying Normal Measurement Data

«For a functional description, see section 1.5.»

This section applies when the measurement mode is set to normal measurement.

### Keys

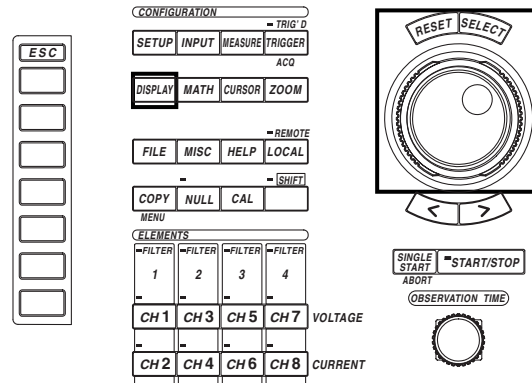

- The  mark indicates the keys that are used for the operation.
- To exit the menu during operation, press the ESC key.

### Procedure

Set the measurement mode to normal measurement. For the procedures, see section, 5.1 “Selecting the Measurement Mode.”

1. Press the SETUP key to display the Setup menu. Confirm that [Mode] is set to [Normal].
2. Press the DISPLAY key to display the Display setting menu.
3. Press the [Format] soft key to display the display format selection box.

### Displaying numerical data

- **Displaying only the numerical data**
4. Turn the jog shuttle to select [Numeric].
  5. Press the SELECT key to confirm the selection.

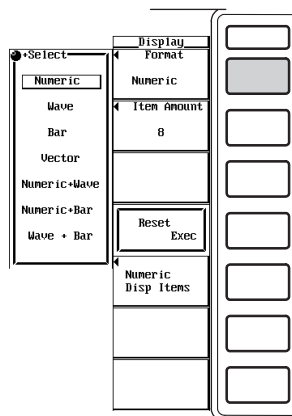

• **Displaying numerical data and waveforms**

4. Turn the jog shuttle to select [Numeric+Wave].
5. Press the SELECT key to confirm the selection.

For the procedures related to setting the waveform display, see chapter 9.

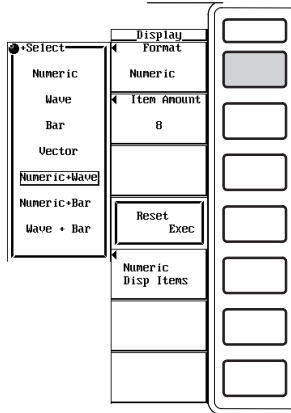

• **Displaying numerical data and bar graphs**

4. Turn the jog shuttle to select [Numeric+Bar].
5. Press the SELECT key to confirm the selection.

The bar graph is useful when making harmonic measurements. For the procedures related to setting the bar graph display, see section 9.10, "Displaying the Bar Graph of Harmonic Data."

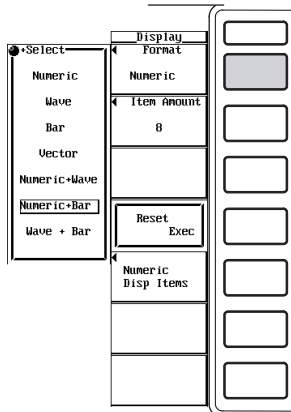

• **Displaying numerical data and X-Y waveform**

4. Turn the jog shuttle to select [Numeric+X-Y].
5. Press the SELECT key to confirm the selection.

X-Y waveform display is applicable to products (PZ4000) with firmware version 2.01 or later. For the procedures related to setting the X-Y waveform display, see section 9.11, "Displaying the X-Y Waveform."

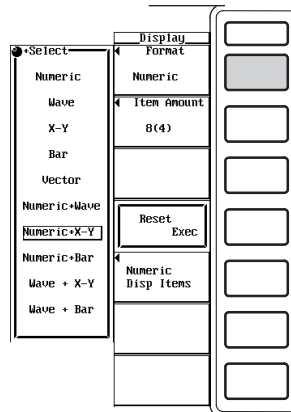



## 8.2 Displaying Normal Measurement Data

The following procedures are given with the premise that “Displaying only the numerical data” was selected in the previous section.

### Selecting the number of displayed items

6. Press the [Item Amount] soft key to display the displayed item number selection menu.
7. Press one of the keys from [8] to [All] to select the number of displayed items.

### Resetting the order of the displayed items

If the number of displayed items is set to something other than [ALL], the order of the displayed items can be reset.

8. Press the [Reset Exec] soft key to reset the order.

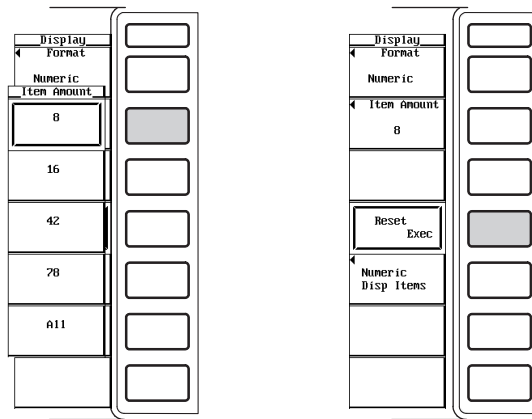

### Scrolling the display

- When the number of displayed items is set to something other than [All]
8. Press the [Numeric Disp Items] soft key to display the menu used to select the number of displayed items.
  9. Turn the jog shuttle to move the highlight to another measurement function. The data number of the highlighted measurement function is displayed in the [Norm Item No.] section of the menu. The symbol representing the highlighted measurement function is displayed in the [Function] section of the menu. The element/wiring method of the highlighted measurement function is displayed in the [Element] section of the menu.

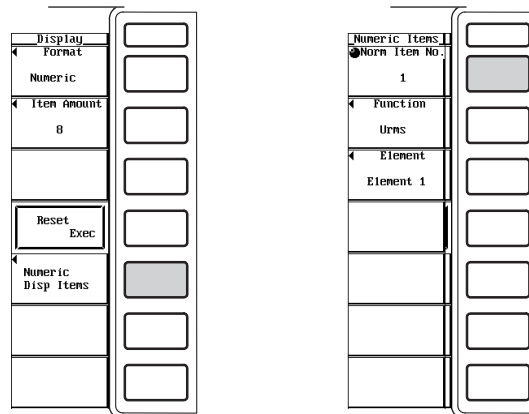

- When the number of displayed items is set to [All]
- Turn the jog shuttle to move the highlight to another measurement function. The symbol representing the highlighted measurement function is displayed in the [Function] section of the menu.
  - Press the ESC key to clear the menu. The numerical data of the sixth item will appear.

	Element1	Element2	Element3	Element4	Σ A	Σ B
UrmsV	1 5.0517	10.2107	0.00000k	0.00000k	5.0517	10.2107
UrmV	1 5.0516	11.3412	0.00000k	0.00000k	5.0516	11.3412
UdcV	1 -0.0315	-0.0307	0.00000k	0.00000k	-0.0315	-0.0307
UacV	1 5.0516	10.2107	0.00000k	0.00000k	5.0516	10.2107
IrmsIA	1 49.805	0.0000	0.0000	0.0000	49.805	0.0000
IrmIA	1 49.799	0.0000	0.0000	0.0000	49.799	0.0000
IdcIA	1 0.823	0.0034	0.0000	0.0000	0.823	0.0034
IacIA	1 49.798	0.0000	0.0000	0.0000	49.798	0.0000
P	1W 1 0.25151k	0.000	0.0000k	0.0000k	0.25151k	0.000
S	1VA 1 0.25160k	0.000	0.0000k	0.0000k	0.25160k	0.000
Q	1var 1 0.00653k	0.000	0.0000k	0.0000k	-0.00653k	0.000
λ	1 0.99966	Error	Error	Error	0.99966	Error
φ	1 ° -1.488	Error	Error	Error	-1.488	Error
fU	1Hz 1 2.000k	2.000k	0.000m	0.000m	-----	-----
fI	1Hz 1 2.000k	0.000m	0.000m	0.000m	-----	-----
U+pkV	1 7.4817	10.2548	Error	Error	-----	-----
U-pkV	1 -7.2653	-10.3346	Error	Error	-----	-----
I+pkIA	1 73.196	0.0346	Error	Error	-----	-----
I-pkIA	1 -71.762	-0.0265	Error	Error	-----	-----
CFU	1 1.438	1.012	Error	Error	-----	-----
CFI	1 1.470	Error	Error	Error	-----	-----
FFU	1 1.111	1.800	Error	Error	-----	-----
FFI	1 1.111	Error	Error	Error	-----	-----
Z	1Ω 1 101.431n	Error	Error	Error	101.431n	Error
Rs	1 101.396n	Error	Error	Error	101.396n	Error

**Explanation**

For the meanings of the measurement function symbols, see section 1.2, “Measurement Modes and Measurement/Computation Periods,” 1.7 “Numerical Computation,” appendix 2 “Symbols and Determination of Measurement Functions,” and appendix 3 “Determination of Delta Functions.” For details regarding the wiring methods, A and B, see section 5.2, “Selecting the Wiring Method.”

**Example** The true RMS value of the voltage of element 1

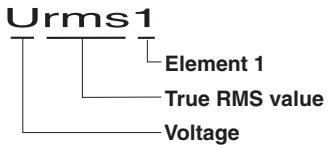

The simple average of the current of the power measurement modules (elements) that are wired using wiring method A

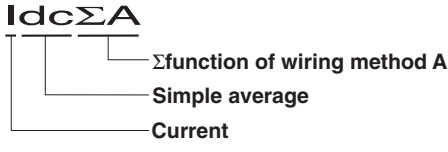

### Selecting the display format

Select the display format of the numerical data from the following choices. No data [---] are displayed in places where the measurement function is not selected or there are no numerical data.

- **Numeric**  
Only numerical data are displayed.
- **Numeric+Wave**  
The numerical data and waveform are displayed separately in the top and bottom windows. For the procedures related to setting the waveform display, see sections 9.1 to 9.8.
- **Numeric+Bar**  
The numerical data and bar graph are displayed separately in the top and bottom windows. The bar graph is useful when making harmonic measurements. For the procedures related to setting the bar graph display, see section 9.10, "Displaying the Bar Graph of Harmonic Data."
- **Numeric+X-Y\***  
The numerical data and X-Y waveform are displayed separately in the top and bottom windows. For the procedures related to setting the X-Y waveform display, see section 9.11, "Displaying the X-Y Waveform."  
\* X-Y waveform display is applicable to products (PZ4000) with firmware version 2.01 or later.

### Selecting the number of displayed items

Select the number of items that are displayed concurrently from the following choices.

- **8**
  - When the display format is [Numeric], eight items of numerical data are displayed in one column.
  - When the display format is other than [Numeric], four items are displayed.
- **16**
  - When the display format is [Numeric], 16 items of numerical data are displayed in two columns.
  - When the display format is other than [Numeric], eight items are displayed.
- **42**
  - When the display format is [Numeric], 42 items of numerical data are displayed in three columns.
  - When the display format is other than [Numeric], 21 items are displayed.
- **78**
  - When the display format is [Numeric], 78 items of numerical data are displayed in three columns.
  - When the display format is other than [Numeric], 39 items are displayed.
- **All**
  - When the display format is [Numeric], a table is displayed containing the numerical data corresponding to the 25 measurement function items vertically, and six symbols indicating the element and wiring method horizontally.
  - When the display format is other than [Numeric], a table is displayed containing the numerical data corresponding to the 12 measurement functions items vertically, and six symbols indicating the element and wiring method horizontally.
  - The sixth horizontal item ( $\Sigma B$ ) is hidden behind the menu. You can view the hidden data by clearing the menu by pressing the ESC key.

**Resetting the order of the displayed items**

If the number of displayed items is set to something other than [ALL], the order of the displayed items can be reset to a preset order. For details regarding the reset information, see Appendix 4, "List of Initial Settings and Display Order of Numerical Data."

**Scrolling the display**

Because all the data cannot fit on one screen, a scroll function is provided.

- **When the number of displayed items is set to something other than [All]**

Turn the jog shuttle to move the highlight to another measurement function. The menu items that are displayed change as follows.

- Norm Item No.

The data number of the highlighted measurement function is displayed.

- Function

The symbol representing the highlighted measurement function is displayed.

When [None] is displayed, an item without a selected measurement function is being specified using the jog shuttle. In this case, the area for displaying the measurement function and data displays [-----] (no data).

- Element

The element/wiring method of the highlighted measurement function is displayed.

- **When the number of displayed items is set to [All]**

Turn the jog shuttle to move the highlight to another measurement function. The symbol representing the highlighted measurement function is displayed in the [Function] section of the menu. [-----] (no data) is displayed in places where there are no numerical data.

**Note**

- For the meanings of the measurement function symbols, see section 1.2, "Measurement Modes and Measurement/Computation Periods," 1.7 "Numerical Computation," appendix 2 "Symbols and Determination of Measurement Functions," and appendix 3 "Determination of Delta Functions."
- For details regarding the wiring methods, A and B, see section 5.2, "Selecting the Wiring Method."
- [-----] (no data) is displayed in places where the measurement function is not selected or there are no numerical data.
- If the measurement/computation results cannot be displayed using the specified decimal point position or unit, [-OF-] (overflow) is displayed.
- When the voltage or current input is less than or equal to 0.25% of the measurement range, Urms, Umn, Uac, Irms, Imn, Iac, and all other measurement functions that are determined using these measurement functions will display zeroes.  $\lambda$  or  $\phi$  will display an error [Error].
- When the frequency of the measured value is outside the measurement range or when the input signal is less than or equal to approximately 3.5% of the measurement range, fU or fI will display an error [Error].
- When both the voltage and current are sinusoids and the ratio of the voltage and current inputs do not differ greatly with respect to the measurement range, the phase difference  $\phi$  of lead (D) and lag (G) are detected and displayed correctly.
- When the power factor  $\lambda$  is greater than 1.001 and less than equal to 2.000,  $\lambda$  becomes [1].  $\phi$  displays zero.
- When the power factor  $\lambda$  is greater than 2.001,  $\lambda$  and  $\phi$  display errors [Error].

## 8.3 Changing the Displayed Items of the Normal Measurement Data

«For a functional description, see section 1.5.»

This section applies when the measurement mode is set to normal measurement.

### Keys

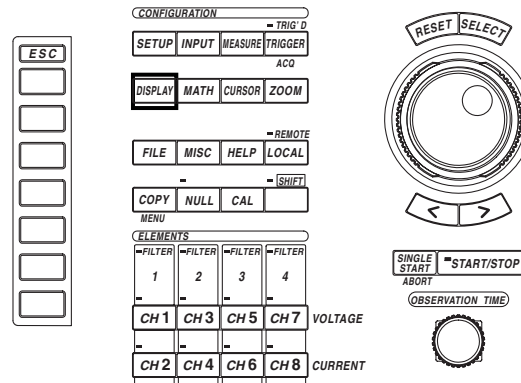

- The   mark indicates the keys that are used for the operation.
- To exit the menu during operation, press the ESC key.

### Procedure

Set the measurement mode to normal measurement. For the procedures, see section 5.1, “Selecting the Measurement Mode.”

1. Press the SETUP key to display the Setup menu. Confirm that [Mode] is set to [Normal].

Set the display format of the numerical data to something other than [All]. For the procedures, see section 8.2, “Displaying Normal Measurement Data.”

2. Press the DISPLAY key to display the Display setting menu. Check that [Format] is set to [Numeric], [Numeric+Wave], [Numeric+Bar], or [Numeric+X-Y]\*.

Check that [Item Amount] is set to [8], [16], [42], or [78].

\* X-Y waveform display is applicable to products (PZ4000) with firmware version 2.01 or later.

### 8.3 Changing the Displayed Items of the Normal Measurement Data

The following procedures are given with the premise that the display format is set to [Numeric].

3. Press the [Numeric Disp Items] soft key to display the menu used to select the number of displayed items.

#### Selecting the item to change

4. Turn the jog shuttle to select (highlight) the item to change.

#### Changing the measurement function

5. Press the [Function] soft key to display the measurement function selection box.
6. Turn the jog shuttle to select the measurement function. You can also select not to display the measurement functions (None).
7. Press the SELECT key. The symbol for the selected element or wiring method and the numerical data are displayed at the highlighted position.

#### Changing the element/wiring method

8. Press the [Element] soft key to display the element/wiring method selection box.
9. Turn the jog shuttle to select the element/wiring method from [Element1] to [ $\Sigma$ B].
10. Press the SELECT key. The selected element number or wiring method symbol ( $\Sigma$ function) and the numerical data are displayed at the highlighted position.

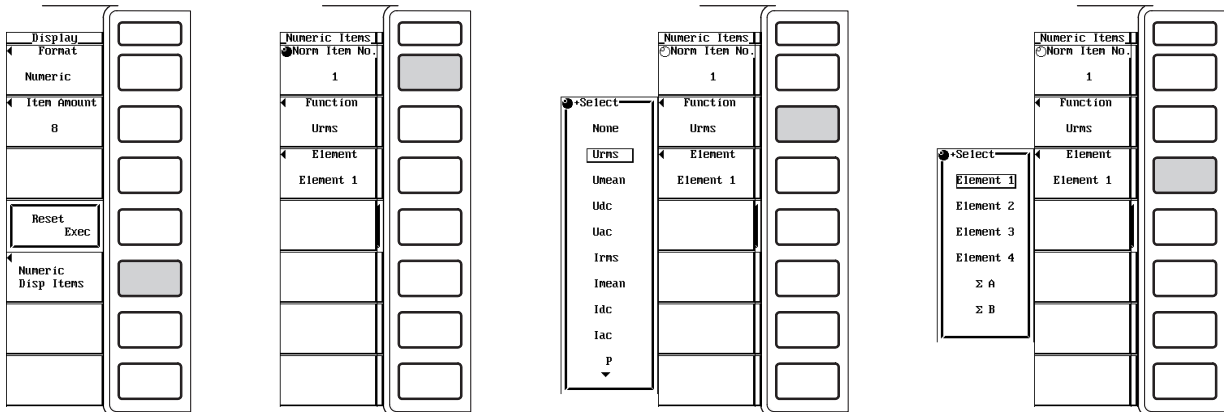

### 8.3 Changing the Displayed Items of the Normal Measurement Data

#### Explanation

For the meanings of the measurement function symbols, see section 1.2, “Measurement Modes and Measurement/Computation Periods,” 1.7 “Numerical Computation,” appendix 2 “Symbols and Determination of Measurement Functions,” and appendix 3 “Determination of Delta Functions.” For details regarding the wiring methods, A and B, see section 5.2, “Selecting the Wiring Method.”

#### Changing the measurement function

- The types of measurement functions that can be selected are indicated in “Measurement Function” in section 1.2 and “Delta Computation” and “User-defined Function” in section 1.7.
- You can also select not to display the measurement functions (None).

#### Changing the element/wiring method

Select the element/wiring method from the following choices.

Element1, Element2, Element3, Element4,  $\Sigma A$ ,  $\Sigma B$

Urms1	5.0517 V		Urms1	5.0517 V
Umn1	5.0516 V		Umn1	5.0516 V
<b>Udc1</b>	-0.0315 V	Changing the measurement function of the third item →	<b>Umn1</b>	5.0516 V
Uac1	5.0516 V		Uac1	5.0516 V
Irms1	5.0530 A		Irms1	5.0530 A
Imn1	5.0551 A		Imn1	5.0551 A
		Changing the element of the third item →	Urms1	5.0517 V
			Umn1	5.0516 V
			<b>Udc2</b>	-0.0307 V
			Uac1	5.0516 V
			Irms1	5.0530 A
			Imn1	5.0551 A

#### Note

- For the meanings of the measurement function symbols, see section 1.2, “Measurement Modes and Measurement/Computation Periods,” 1.7 “Numerical Computation,” appendix 2 “Symbols and Determination of Measurement Functions,” and appendix 3 “Determination of Delta Functions.”
- For details regarding the wiring methods, A and B, see section 5.2, “Selecting the Wiring Method.”
- [-----] (no data) is displayed in places where the measurement function is not selected or there are no numerical data.

## 8.4 Displaying Harmonic Measurement Data

«For a functional description, see section 1.5.»

This section applies when the measurement mode is set to harmonic measurement.

### Keys

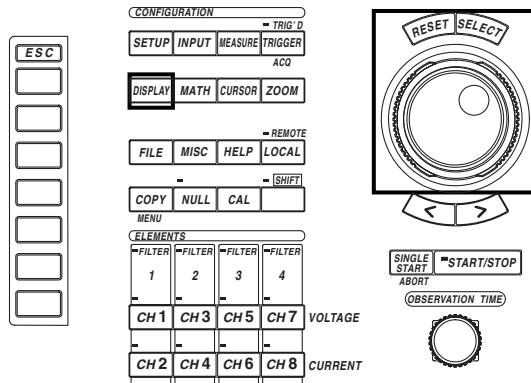

- The  mark indicates the keys that are used for the operation.
- To exit the menu during operation, press the ESC key.

### Procedure

Set the measurement mode to harmonic measurement. For the procedures, see section 5.1, “Selecting the Measurement Mode.”

1. Press the SETUP key to display the Setup menu. Confirm that [Mode] is set to [Harmonics].
2. Press the DISPLAY key to display the Display setting menu.
3. Press the [Format] soft key to display the display format selection box.

### Displaying numerical data

- **Displaying only the numerical data**
4. Turn the jog shuttle to select [Numeric].
  5. Press the SELECT key to confirm the selection.

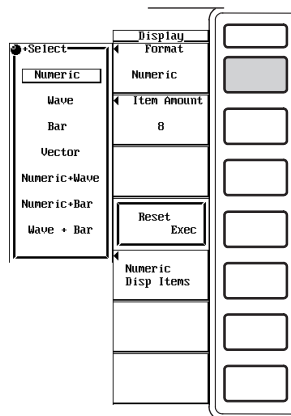



## 8.4 Displaying Harmonic Measurement Data

- **Displaying numerical data and waveforms**

4. Turn the jog shuttle to select [Numeric+Wave].
5. Press the SELECT key to confirm the selection.

For the procedures related to setting the waveform display, see chapter 9.

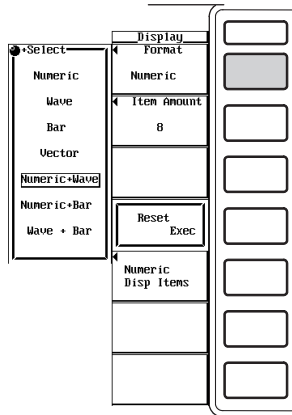

- **Displaying numerical data and bar graphs**

4. Turn the jog shuttle to select [Numeric+Bar].
5. Press the SELECT key to confirm the selection.

The bar graph is useful when making harmonic measurements. For the procedures related to setting the bar graph display, see section 9.10, “Displaying the Bar Graph of Harmonic Data.”

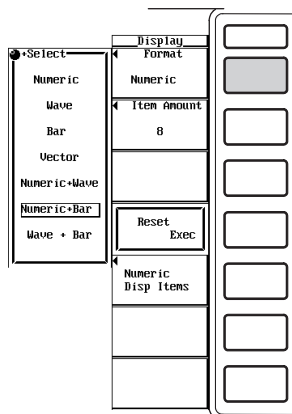

- **Displaying numerical data and X-Y waveform**

4. Turn the jog shuttle to select [Numeric+X-Y].
5. Press the SELECT key to confirm the selection.

X-Y waveform display is applicable to products (PZ4000) with firmware version 2.01 or later. For the procedures related to setting the X-Y waveform display, see section 9.11, “Displaying the X-Y Waveform.”

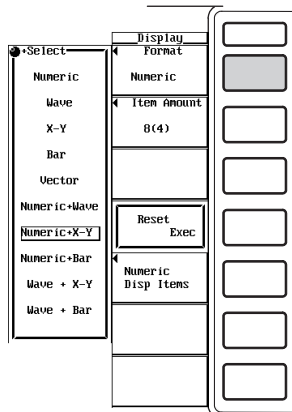

The following procedures are given with the premise that “Displaying only the numerical data” was selected in the previous section.

**Selecting the number of displayed items or list display**

6. Press the [Item Amount] soft key to display the menu used to select the number of displayed items.
7. Press one of the keys from [8] to [ΣList] to select the number of displayed items.

**Resetting the order of the displayed items**

If the number of displayed items is set to [8] or [16], the order of the displayed items can be reset.

8. Press the [Reset Exec] soft key to reset the order.

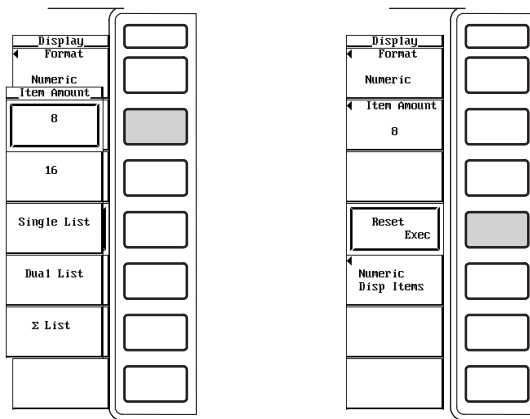

**Scrolling the display**

- When the number of displayed items is set to [8] or [16]

8. Press the [Numeric Disp Items] soft key to display the menu used to select the number of displayed items.
9. Press the [Harm Item No.] soft key.
10. Turn the jog shuttle to move the highlight to another measurement function. The data number of the highlighted measurement function is displayed in the [Harm Item No.] section of the menu. The symbol representing the highlighted measurement function is displayed in the [Function] section of the menu. The element/wiring method of the highlighted measurement function is displayed in the [Element] section of the menu. The harmonic order of the highlighted measurement function is displayed in the [order] section of the menu that is used to select the number of displayed items.

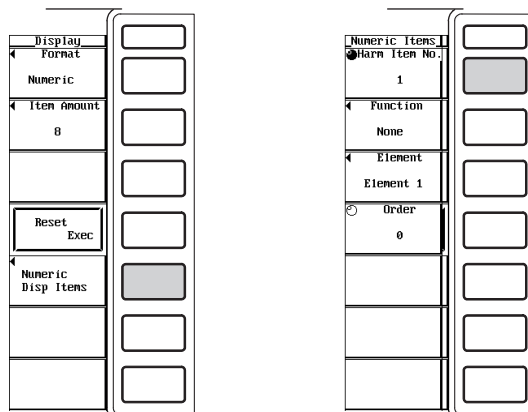

## 8.4 Displaying Harmonic Measurement Data

- When [Single List] or [Dual List] is selected

8. Turn the jog shuttle to move the highlight over the data corresponding to a different order.

The harmonic order of the data being highlighted is displayed in the [Order] section of the Display setting menu.

PLL	CHI(U1)	Or.	5.0545	dc	1.0429	20.633	Or.	4.7348	dc	-0.9530	-1.120
Freq	49 Hz	1	4.0427	29.982	2	3.0339	60.023	1	4.0427	29.982	0.363
U1	5.0545 U	5	0.0059	0.117	6	0.0048	0.096	2	3.0339	60.023	0.396
I1	4.7348 A	7	0.0037	0.072	8	0.0041	0.080	3	0.0144	0.285	0.304
P1	0.067 W	9	0.0021	0.041	10	0.0021	0.043	4	0.0060	0.135	0.381
S1	0.002 VA	11	0.0022	0.044	12	0.0022	0.043	5	0.0059	0.117	0.404
Q1	0.047 var	13	0.0022	0.043	14	0.0016	0.032	6	0.0040	0.096	0.425
λ1	0.81634	15	0.0018	0.035	16	0.0014	0.029	7	0.0037	0.072	0.405
φ1	-35.279 °	17	0.0009	0.018	18	0.0013	0.026	8	0.0041	0.080	0.472
Uthd	75.048	19	0.0015	0.030	20	0.0012	0.023	9	0.0021	0.041	0.489
Ithd	7524.637	21	0.0007	0.013	22	0.0012	0.023	10	0.0021	0.043	0.477
Pthd	3.055	23	0.0012	0.023	24	0.0007	0.014	11	0.0022	0.044	0.596
Uthf	Error	25	0.0004	0.008	26	0.0011	0.022	12	0.0022	0.043	0.611
Ithf	Error	27	0.0008	0.016	28	0.0014	0.028	13	0.0022	0.043	0.624
Utif	1.960	29	0.0008	0.016	30	0.0007	0.014	14	0.0016	0.032	0.844
Itif	4999.054	31	0.0009	0.018	32	0.0010	0.021	15	0.0010	0.035	0.943
hwf	0.424	33	0.0000	0.016	34	0.0006	0.011	16	0.0014	0.029	0.992
hcf	0.224	35	0.0010	0.019	36	0.0010	0.020	17	0.0009	0.018	1.505
U2	5.0383 U	37	0.0010	0.020	38	0.0007	0.014	18	0.0013	0.026	2.168
I2	0.0011 A	41	0.0002	0.004	42	0.0004	0.007	19	0.0015	0.030	19
P2	-0.000 W	43	0.0006	0.011	44	0.0005	0.010	20	0.0012	0.023	20
S2	0.000 VA	45	0.0004	0.009	46	0.0007	0.014	21	0.0007	0.013	21
								22	0.0012	0.023	22
											1.594

- When [Σ List] is selected.

8. Turn the jog shuttle to change the harmonic order that is displayed in the [Order] section of the Display setting menu. The measurement functions U, I, P, S, Q, λ, φ, and so on for that order are displayed.

U	I	P	S	Q	λ	φ	Element1	Element2	Element3	Element4	Σ A	Σ B
I	Ia	I	Ia	I	I	I	4.0523	4.0364	4.0490	4.0520	4.0523	4.0364
I	Ia	I	Ia	I	I	I	0.00074	0.005m	0.004m	0.0042	0.00074	0.005m
P	I	I	I	I	I	I	-0.001	0.00002	0.00002	-0.00002k	-0.001	0.00002
S	I	I	I	I	I	I	0.003	0.00002	0.00002	0.00002k	0.003	0.00002
Q	I	I	I	I	I	I	-0.003	0.00000	0.00000	-0.00001k	-0.003	0.00000
λ	I	I	I	I	I	I	1-0.33571	0.93896	0.99904	-0.90485	-0.33571	0.93896
φ	I	I	I	I	I	I	1-109.616	2.620	2.509	-154.803		

Page scrolling the display

You can page scroll when [Single List] or [Dual List] is selected.

- Listing the numerical data corresponding to the harmonic orders that are higher than those currently displayed
  8. Press the [Page Down Scroll Exec] soft key. The numerical data of the higher harmonic order is listed.
  9. Press the [Page Down Scroll Exec] soft key repeatedly until the section of the list containing the desired order is reached. You can page scroll to view up to a 500th order harmonic.
- Listing the numerical data corresponding to a harmonic order that is smaller than those currently displayed
  10. Press the [Page Up Scroll Exec] soft key. The numerical data of the lower harmonic order is listed.
  11. Press the [Page Up Scroll Exec] soft key repeatedly until the section of the list containing the desired order is reached. You can page scroll down as far as Total or dc (0th order).

	Or.	Dr.		Or.	Dr.
PLL	GH(U1)	0.0295	31.961	2	-0.0194
Freq	49 Hz	0.0094	11.845	4	0.0046
U1	0.0295 V	0.0040	13.644	6	0.0008
I1	0.0011 A	0.0027	9.002	8	0.0012
P1	-0.000 W	0.0006	1.940	10	0.0005
S1	0.000 VAR	0.0005	1.554	12	0.0000
Q1	0.000 VAR	0.0006	2.006	14	0.0005
A1	-0.07644	0.0005	1.663	16	0.0004
Uthd	151.216 *	0.0002	0.511	18	0.0003
Ithd	296.471	0.0006	1.907	20	0.0005
Pthd	482.932	0.0002	0.673	22	0.0006
Uthf	268.053	0.0003	0.993	24	0.0006
Ithf	Error	0.0007	2.248	26	0.0003
Utif	Error	0.0005	1.813	28	0.0004
Uthf	Error	0.0004	1.305	30	0.0003
Utif	0.000	0.0002	0.791	32	0.0001
hwf	0.194	0.0002	0.517	34	0.0005
hcf	0.210	0.0006	2.100	36	0.0000
U2	0.00017kV	0.0011	3.760	38	0.0000
I2	69.707 A	0.0010	3.396	40	0.0022
P2	-0.001kVA	0.0009	5.296	42	0.0022
S2	0.001kVA	0.0035	11.721	46	0.0169
Ithf	Error	0.0009	3.038	96	0.0011
Utif	0.000	0.0007	2.398	98	0.0005
Ithf	0.000	0.0002	0.626	100	0.0006
hwf	0.201			102	
hcf	0.198			104	
U4	0.00041kV			106	
I4	0.0027 A			108	
P4	-0.0000kVA			110	
S4	0.0000kVA			112	
Q4	0.0000kvar			114	
A4	-0.07691			116	
Uthd	151.272 *			118	
Ithd	1759.659			120	
Pthd	1944.546			122	
Uthf	Error			124	
Ithf	Error			126	
Utif	0.000			128	
hwf	0.205			130	
hcf	0.181			132	
U2a	0.0295 V			134	
				136	
				138	
				140	
				142	
				144	
				146	
				148	
				150	

## 8.4 Displaying Harmonic Measurement Data

### Explanation

For the meanings of the measurement function symbols, see section 1.2, “Measurement Modes and Measurement/Computation Periods,” 1.7 “Numerical Computation,” and appendix 2 “Symbols and Determination of Measurement Functions.” For details regarding the wiring methods, A and B, see section 5.2, “Selecting the Wiring Method.”

#### Example The voltage of the 20th order harmonic of element 2

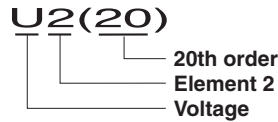

#### The average of the current corresponding to the 30th order harmonic of the power measurement modules (element) that are wired using wiring method B

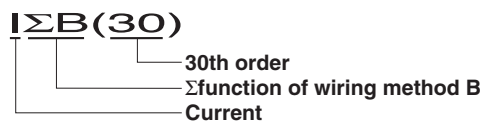

#### Selecting the display format

Select the display format of the numerical data from the following choices. No data [----] are displayed in places where the measurement function is not selected or there are no numerical data.

- **Numeric**  
Only numerical data are displayed.
- **Numeric+Wave**  
The numerical data and waveform are displayed separately in the top and bottom windows. For the procedures related to setting the waveform display, see sections 9.1 to 9.8.
- **Numeric+Bar**  
The numerical data and bar graph are displayed separately in the top and bottom windows. The bar graph is useful when making harmonic measurements. For the procedures related to setting the bar graph display, see section 9.10, “Displaying the Bar Graph of Harmonic Data.”
- **Numeric+X-Y\***  
The numerical data and X-Y waveform are displayed separately in the top and bottom windows. For the procedures related to setting the X-Y waveform display, see section 9.11, “Displaying the X-Y Waveform.”

\* X-Y waveform display is applicable to products (PZ4000) with firmware version 2.01 or later.

#### Selecting the number of displayed items or list display

Select the number of items that are to be displayed concurrently or list displays from the following choices.

- **8**
  - When the display format is [Numeric], eight items of numerical data are displayed in one column.
  - When the display format is other than [Numeric], four items are displayed.
- **16**
  - When the display format is [Numeric], 16 items of numerical data are displayed in two columns.
  - When the display format is other than [Numeric], eight items are displayed.

- Single List
  - When the display format is [Numeric], 48 items of numerical data of one type of measurement function are displayed in two columns.
  - When the display format is other than [Numeric], 22 items of numerical data of one type of measurement function are displayed in two columns.
- Dual List
  - When the display format is [Numeric], 24 items of numerical data of two types of measurement functions are displayed in each column.
  - When the display format is other than [Numeric], 11 items of numerical data of two types of measurement functions are displayed in each column.
- $\Sigma$  List
  - A table indicating the numerical data for each measurement item is displayed. The measurement functions U, I, P, S, Q,  $\lambda$ ,  $\phi$ , and so on are displayed vertically and symbols representing the elements and wiring methods are displayed horizontally.
  - The sixth horizontal item ( $\Sigma B$ ) is hidden behind the menu. You can view the hidden data by clearing the menu by pressing the ESC key.

#### Resetting the order of the displayed items

If the number of displayed items is set to [8] or [16], the order of the displayed items can be reset to a preset order. For details regarding the reset information, see Appendix 4, "List of Initial Settings and Display Order of Numerical Data."

#### Scrolling the display

Because all the data cannot fit on one screen, a scroll function is provided.

- **When the number of displayed items is set to [8] or [16]**

Turn the jog shuttle to move the highlight to another measurement function. The menu items that are displayed change as follows.

  - Harm Item No.  
The data number of the highlighted measurement function is displayed.
  - Function  
The symbol representing the highlighted measurement function is displayed. When [None] is displayed, an item without a selected measurement function is being specified using the jog shuttle. In this case, the area for displaying the measurement function and data displays [-----] (no data).
  - Element  
The element/wiring method of the highlighted measurement function is displayed.
  - Order  
The harmonic order of the highlighted measurement function is displayed (Total or dc (0th order) up to 500th order).
- **When [Single List] or [Dual List] is selected**

Total or dc (0th order) up to 500th order is displayed in the [order] section of the Display setting menu. When the selected measurement function is U, I, or P, the harmonic distortion factor, Uhdf, Ihdf, or Phdf is displayed, respectively. When the measurement function is some function other than U, I, or P, [-----] (no data) is displayed in place where the harmonic distortion factor is to be displayed.

## 8.4 Displaying Harmonic Measurement Data

---

- **When [Σ List] is selected**

Total or dc (0th order) up to 500th order is displayed in the [order] section of the Display setting menu. The measurement functions U, I, P, S, Q,  $\lambda$ ,  $\phi$ , and so on for the harmonic order are displayed.

**Page scrolling the display**

You can page scroll when [Single List] or [Dual List] is selected.

- You can page scroll to list the numerical data corresponding to harmonic orders that are higher than those currently displayed (up to 500th order).
- You can page scroll to list the numerical data corresponding to harmonic orders that are lower than those currently displayed (down as far as Total or dc (0th order)).

**Note**

---

- For the meanings of the measurement function symbols, see section 1.2, "Measurement Modes and Measurement/Computation Periods," 1.7 "Numerical Computation," and appendix 2 "Symbols and Determination of Measurement Functions."
  - For details regarding the wiring methods, A and B, see section 5.2, "Selecting the Wiring Method."
  - You can display the harmonic order from Total or dc (0th order) up to 500th order. However, numerical data that correspond to harmonic orders up to the upper limit of the analysis determined by the frequency of the PLL source are actually determined from the harmonic measurement.
  - [-----] (no data) is displayed in places where the measurement function is not selected or there are no numerical data.
  - If the measurement/computation results cannot be displayed using the specified decimal point position or unit, [-OF-] (overflow) is displayed.
  - When the frequency of the measured value is outside the measurement range or when the input signal is less than or equal to approximately 3.5% of the measurement range, fU or fI will display an error [Error].
  - The phase difference during the harmonic measurement mode is displayed according to the result of the equation given in Appendix 2.
  - When the power factor  $\lambda$  is greater than 1.001 and less than equal to 2.000,  $\lambda$  becomes [1].  $\phi$  displays zero.
  - When the power factor  $\lambda$  is greater than 2.001,  $\lambda$  and  $\phi$  display errors [Error].
- 

**Precautions when displaying the measurement functions of the motor module in the harmonic measurement mode**

For the meanings of the measurement function symbols used in the explanation below, see section 15.2 and the following sections or appendix 2.

- The numerical data of Speed, Torque, Sync, Slip, Pm,  $\eta$ mA, and  $\eta$ mB are 0th order (DC) components. The default setting of the minimum order (Min Order) in the harmonic measurement mode is 1. To display the numerical data of Speed, Torque, Sync, Slip, Pm,  $\eta$ mA, and  $\eta$ mB, the minimum order must be set to 0.
- The numerical data of Torque in the normal measurement mode are simple averaged values. The numerical data of each harmonic component and the total of Torque in the harmonic measurement mode are RMS values. The numerical data that correspond to the same value as the normal measurement mode are displayed at Trq (dc).
- The 0th (DC) component of Speed and Pm are displayed as total numerical data.
- The numerical data of Sync and Slip are displayed only when the PLL source (PII Source) and frequency synchronization source (Sync Speed Source) are set to the same channel.
- $\eta$ mA displays the ratio of Pm total with respect to PΣA total;  $\eta$ mB displays the ratio of Pm total with respect to PΣB total.

## 8.5 Changing the Displayed Items of the Harmonic Measurement Data

«For a functional description, see section 1.5.»

This section applies when the measurement mode is set to harmonic measurement.

### Keys

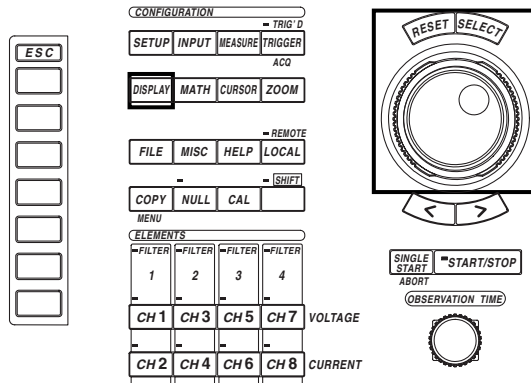

- The  mark indicates the keys that are used for the operation.
- To exit the menu during operation, press the ESC key.

### Procedure

Set the measurement mode to harmonic measurement. For the procedures, see section 5.1, “Selecting the Measurement Mode.”

1. Press the SETUP key to display the Setup menu. Confirm that [Mode] is set to [Harmonics].

Set the display format of the numerical data to something other than [Σ List]. For the procedures, see section 8.4, “Displaying Harmonic Measurement Data.”

2. Press the DISPLAY key to display the Display setting menu. Check that [Format] is set to [Numeric], [Numeric+Wave], [Numeric+Bar], or [Numeric+X-Y]\*. Check that [Item Amount] is set to [8], [16], [Single List], [Dual List], or [Σ List].
  - \* X-Y waveform display is applicable to products (PZ4000) with firmware version 2.01 or later.



## 8.5 Changing the Displayed Items of the Harmonic Measurement Data

The following procedures are given with the premise that the display format is set to [Numeric].

When the number of displayed items is set to [8] or [16]

3. Press the [Numeric Disp Items] soft key to display the menu used to select the number of displayed items.

- **Selecting the item to change**

4. Press the [Harm Item No.] soft key.
5. Turn the jog shuttle to select (highlight) the item to change.

- **Changing the measurement function**

6. Press the [Function] soft key to display the measurement function selection box.
7. Turn the jog shuttle to select the measurement function. You can also select not to display the measurement functions (None).
8. Press the SELECT key. The symbol for the selected element or wiring method and numerical data are displayed at the highlighted position.

- **Changing the element/wiring method**

9. Press the [Element] soft key to display the element/wiring method selection box.
10. Turn the jog shuttle to select the element/wiring method from [Element1] to [ΣB].
11. Press the SELECT key. The selected element number or wiring method symbol (Σfunction) and the numerical data are displayed at the highlighted position.

- **Changing the harmonic order**

12. Press the [Order] soft key.
13. Turn the jog shuttle to select the order. The selected order and numerical data are displayed at the highlighted position.

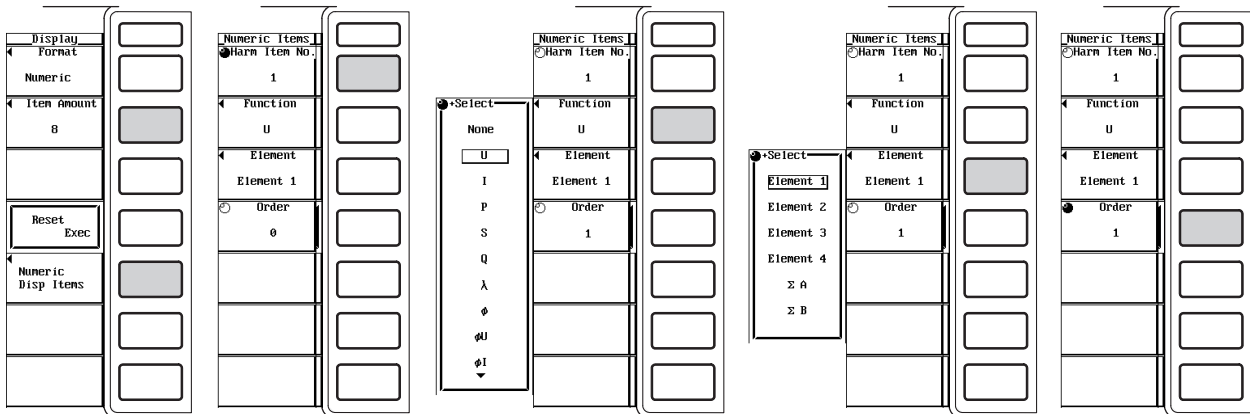

**When [Single List] or [Dual List] is selected**

3. Press the [List Items] soft key to display the menu used to change the display item.

- **Selecting the item to change**

4. Press the [List Item No.] soft key.
5. Turn the jog shuttle to select [1] or [2]. The selected list item is displayed.

- **Changing the measurement function**

6. Press the [Function] soft key to display the measurement function selection box.
7. Turn the jog shuttle to select the measurement function.
8. Press the SELECT key. The symbol for the selected element or wiring method and numerical data are displayed at the highlighted position.

- **Changing the element/wiring method**

9. Press the [Element] soft key to display the element/wiring method selection box.
10. Turn the jog shuttle to select the element/wiring method from [Element1] to [ΣB].
11. Press the SELECT key. The symbol for the selected element or wiring method and numerical data are displayed at the highlighted position.

- **Changing the harmonic order**

12. Press ESC key to return to the Display setting menu.
13. Turn the jog shuttle to select the order. The display is scrolled to show the selected order and numerical data. You can also page scroll (see section 8.4).

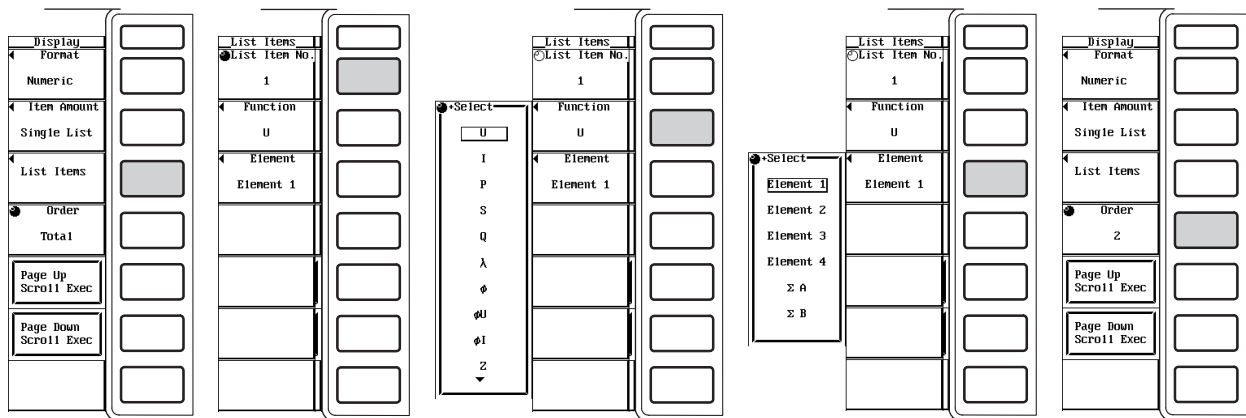

## 8.5 Changing the Displayed Items of the Harmonic Measurement Data

### Explanation

For the meanings of the measurement function symbols, see section 1.2, “Measurement Modes and Measurement/Computation Periods,” 1.7 “Numerical Computation,” and appendix 2 “Symbols and Determination of Measurement Functions.” For details regarding the wiring methods, A and B, see section 5.2, “Selecting the Wiring Method.”

#### When the number of displayed items is set to [8] or [16]

- **Changing the measurement function**
  - The types of measurement functions that can be selected are indicated in “Measurement Function” in section 1.2 (excluding the  $\Sigma$  function) and “User-defined Function” in section 1.7.
  - You can also select not to display the measurement functions (None).

- **Changing the element/wiring method**

Select the element/wiring method from the following choices.

Element1, Element2, Element4, Element4,  $\Sigma A$ ,  $\Sigma B$

- **Changing the harmonic order**

You can specify the harmonic order from Total or dc (0th order) up to 500th order.

U1(1)	0.0094 V		U1(1)	0.0094 V
I1(1)	0.0002 A	Changing the measurement function of the third item	I1(1)	0.0002 A
P1(1)	-0.000 W		$\phi 1(1)$	130.853 °
S1(1)	0.000 VA		S1(1)	0.000 VA
		Changing the element of the third item	U1(1)	0.0094 V
			I1(1)	0.0002 A
			P2(1)	-0.001kW
			S1(1)	0.000 VA
			Changing the harmonic order	
			U1(1)	0.0094 V
			I1(1)	0.0002 A
			P2(36)	0.000kW
			S1(1)	0.000 VA

### When [Single List] or [Dual List] list is selected

- **Selecting the item to change**

Two types of lists can be specified. For [Single List], the list of item No. 1 is displayed in two columns. For [Dual List], both lists are displayed in each column. You can select [1] or [2] for the list item No.

- **Changing the measurement function**

Select the measurement function to change from the following choices.

Note (no measurement function), U, I, P, S, Q,  $\lambda$ ,  $\phi$ ,  $\phi U$ ,  $\phi I$ , Z, Rs, Xs, Rp, Xp, Torque\*

\* This is applicable to products (PZ4000) with firmware version 2.01 or later when the motor module is installed in the element number 4 slot.

- **Changing the element/wiring method**

It is the same as the description given for “When the number of displayed items is set to [8] or [16]” on the previous page.

The measurement function [Torque] is applicable only to products (PZ4000) with firmware version 2.01 or later when the motor module installed in the element number 4 slot.

Therefore, the selected element is set to some measurement function other than [Torque].

- **Changing the harmonic order**

It is the same as the description given for “When the number of displayed items is set to [8] or [16]” on the previous page.

### Note

---

- For the meanings of the measurement function symbols, see section 1.2, “Measurement Modes and Measurement/Computation Periods,” 1.7 “Numerical Computation,” and appendix 2 “Symbols and Determination of Measurement Functions.”
  - For details regarding the wiring methods, A and B, see section 5.2, “Selecting the Wiring Method.”
  - [-----] (no data) is displayed in places where the measurement function is not selected or there are no numerical data.
  - You can display the harmonic order from Total or dc (0th order) up to 500th order. However, numerical data that correspond to harmonic orders up to the upper limit of the analysis determined by the frequency of the PLL source are actually determined from the harmonic measurement.
-

# 9.1 Selecting the Channel to Display

«For a functional description, see section 1.6.»

## Keys

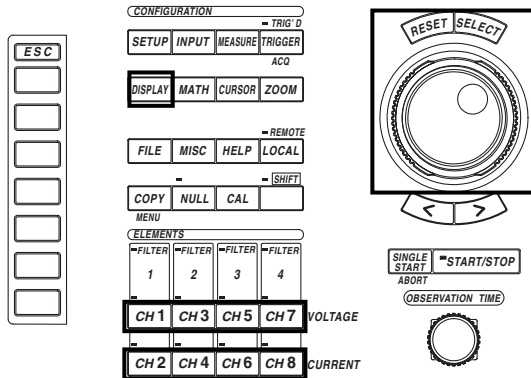

- The  mark indicates the keys that are used for the operation.
- To exit the menu during operation, press the ESC key.

## Procedure

### Selecting from the Display setting menu

1. Press the DISPLAY key to display the Display setting menu.
2. Press the [Format] soft key to display the display format selection box.

### Displaying the waveform

- **Displaying only the waveform**
3. Turn the jog shuttle to select [Wave].
  4. Press the SELECT key to confirm the selection.

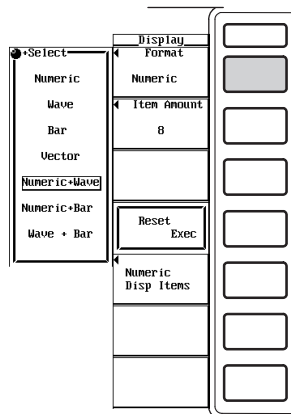

## 9.1 Selecting the Channel to Display

- **Displaying numerical data and the waveform**

3. Turn the jog shuttle to select [Numeric+Wave].
4. Press the SELECT key to confirm the selection.

For the procedures related to setting the numerical display, see chapter 8.

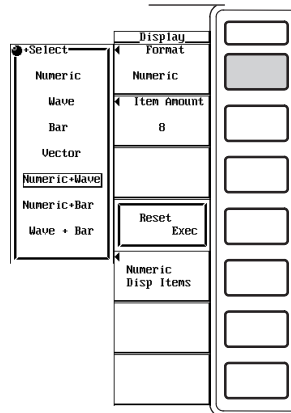

- **Displaying the waveform and the bar graph**

3. Turn the jog shuttle to select [Wave+Bar].
4. Press the SELECT key to confirm the selection.

The bar graph is useful when making harmonic measurements. For the procedures related to setting the bar graph display, see section 9.10, "Displaying the Bar Graph of Harmonic Data."

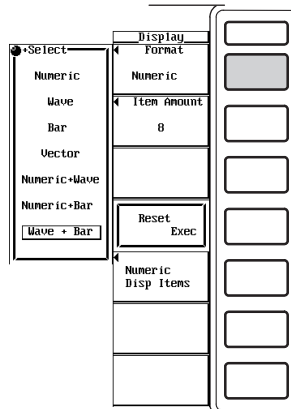

- **Displaying waveform and X-Y waveform**

4. Turn the jog shuttle to select [Wave+X-Y].
5. Press the SELECT key to confirm the selection.

X-Y waveform display is applicable to products (PZ4000) with firmware version 2.01 or later. For the procedures related to setting the X-Y waveform display, see section 9.11, "Displaying the X-Y Waveform."

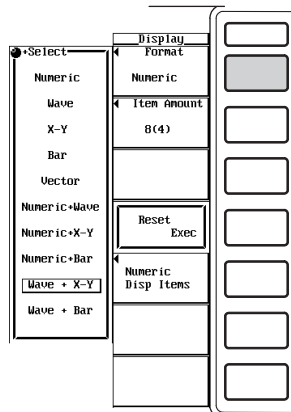

The following procedures are given with the premise that “Display only the numerical data” was selected in the previous section.

5. Press the [Wave Setting] soft key to display the waveform menu.
6. Press the [Wave Display] soft key to display the waveform display selection box.

**Turn ON/OFF the waveform display of each channel (includes computed waveforms)**

7. Turn the jog shuttle to select the desired channel.
8. Press the SELECT key. When the button to the left of the channel in the waveform display selection box is highlighted, the waveform of that channel is displayed. If it is not highlighted, the waveform is not displayed.

**Turn ON/OFF the waveform display for all channels (includes computed waveforms) simultaneously**

• **Turning ON the waveforms simultaneously**

7. Turn the jog shuttle to select [All ON].
8. Press the SELECT key. All the buttons to the left of the channels in the waveform display selection box are highlighted and the waveforms of all channels are displayed.

• **Turning OFF the waveform simultaneously**

9. Turn the jog shuttle to select [All OFF].
10. Press the SELECT key. All the buttons to the left of the channels in the waveform display selection box are no longer highlighted and the waveforms of all channels are turned OFF.

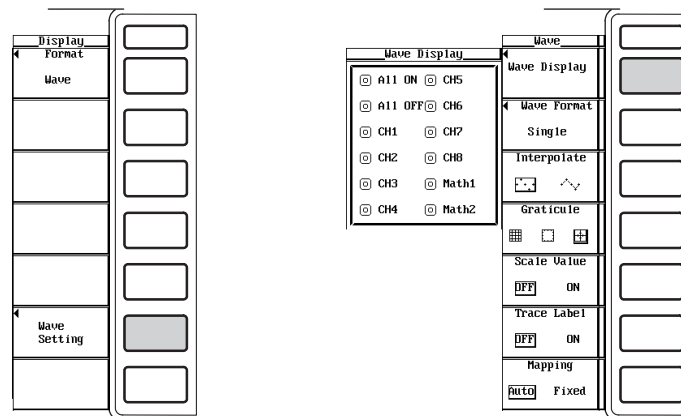

### Selecting from the channel setting menu

You cannot turn ON/OFF the computed waveform using this procedure.

#### Turning ON/OFF the waveform display

1. Press the desired channel key from CH1 to CH8. The channel setting menu is displayed.
2. Press the [Wave Display] soft key to select [ON] or [OFF].

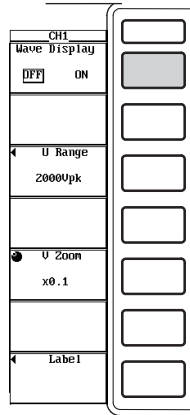

#### Explanation

#### Selecting the display format

Select the display format from the following list of choices.

- Wave  
Only the waveform is displayed.
- Numeric+Wave  
The numerical data and waveform are displayed separately in the top and bottom windows. For the procedures related to setting the numerical display, see chapter 8.
- Wave+Bar  
Waveforms and bar graphs are displayed separately in the top and bottom windows. The bar graphs is useful when making harmonic measurements. For the procedures related to setting the bar graph display, see section 9.10, "Displaying the Bar Graph of Harmonic Data."
- Wave+X-Y  
The waveform and X-Y waveform are displayed separately in the top and bottom windows. For the procedures related to setting the X-Y waveform display, see section 9.11, "Displaying the X-Y Waveform."
  - \* X-Y waveform display is applicable to products (PZ4000) with firmware version 2.01 or later.

#### Selecting the display channel

The waveform of each channel can be turned ON/OFF. The range of channels is from CH1 to CH8 which correspond to the elements that have input modules installed. In addition, computed waveforms (Math1 and Math2) described later (see chapter 11) can be turned ON/OFF.

The indicator on the top left corner of the channel key lights when the display of the channel is turned ON.

#### Note

- Channels (elements) that do not have modules installed cannot be turned ON.
- When a waveform is loaded from a storage medium, the input waveform can no longer be displayed.



## 9.2 Moving the Vertical Position

«For a functional description, see section 1.6.»

### Keys

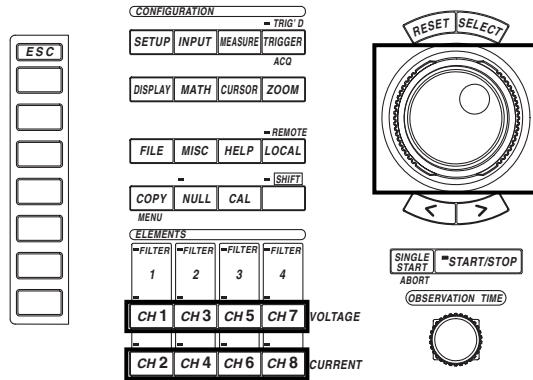

- The  mark indicates the keys that are used for the operation.
- To exit the menu during operation, press the ESC key.

### Procedure

Select a display format to display the waveforms. For the procedures, see section 9.1, “Selecting the Channel to Display.”

1. Press the DISPLAY key to display the Display setting menu.
2. Press the [Format] soft key to display the display format selection box. Check that [Format] is set to [Wave], [Numeric+Wave], [Wave+Bar], or [Wave+X-Y].  
\* X-Y waveform display is applicable to products (PZ4000) with firmware version 2.01 or later.

The following procedures are given with the premise that the display format is set to [Wave].

(Movement of the vertical position is applicable to products (PZ4000) with firmware version 2.01 or later.)

3. Press the desired channel key from CH1 to CH8. The channel setting menu is displayed.
4. Press the “Position” soft.
5. Turn the jog shuttle to move the vertical position of the waveform.

For the procedures related to entering values using the jog shuttle, see section 4.1, “Entering Values and Strings.”

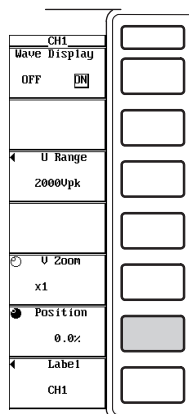

## 9.2 Moving the Vertical Position

---

### Explanation

The displayed position of the waveform (vertical position) can be moved vertically to the desired position such as when the section of the waveform you wish to view goes out of the display frame due to vertical zoom. This is applicable to products (PZ4000) with firmware version 2.01 or later.

- The position can be set in the range from 0.000 to  $\pm 130.000\%$ .
- When the vertical zoom factor is 1 (see section 9.8), half of the total vertical span of the waveform display screen is considered to be 100%. With the center of the vertical axis taken to be the zero amplitude line, the upper and lower limits of the screen are 100% and  $-100\%$ , respectively.

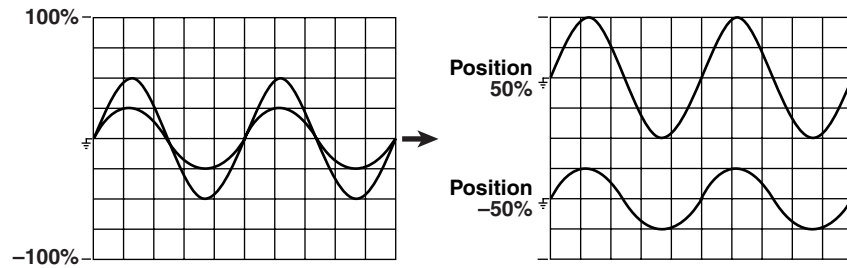

### Note

---

- Vertical position of computed waveforms (Math1 and Math2) cannot be moved.
  - To expand and view a section of the waveform, we recommend the following procedure.
    1. Set the zoom factor to 1.
    2. Move the vertical position so that the desired section of the waveform is at the center position (according to the procedure described in this section).
    3. Set the vertical zoom factor (see section 9.8).
-

## 9.3 Splitting the Screen and Displaying the Waveforms

«For a functional description, see section 1.6.»

### Keys

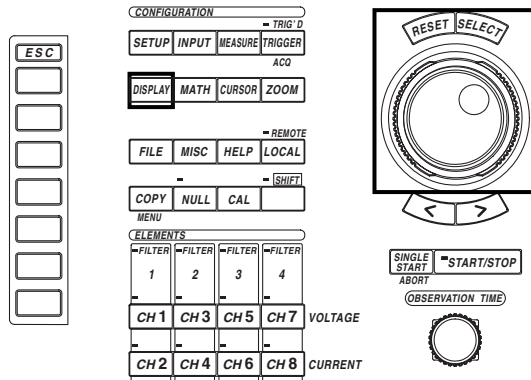

- The  mark indicates the keys that are used for the operation.
- To exit the menu during operation, press the ESC key.

### Procedure

Select a display format to display the waveforms. For the procedures, see section 9.1, “Selecting the Channel to Display.”

1. Press the DISPLAY key to display the Display setting menu.
2. Press the [Format] soft key to display the display format selection box. Check that [Format] is set to [Wave], [Numeric+Wave], [Wave+Bar], or [Wave+X-Y].  
\* X-Y waveform display is applicable to products (PZ4000) with firmware version 2.01 or later.

The following procedures are given with the premise that the display format is set to [Wave].

#### Selecting the number of split windows

3. Press the [Wave Setting] soft key to display the waveform menu.
4. Press the [Wave Format] soft key to display the menu used to select the number of split windows.
5. Press one of the keys from [Single] to [Quad] to select the number of windows.

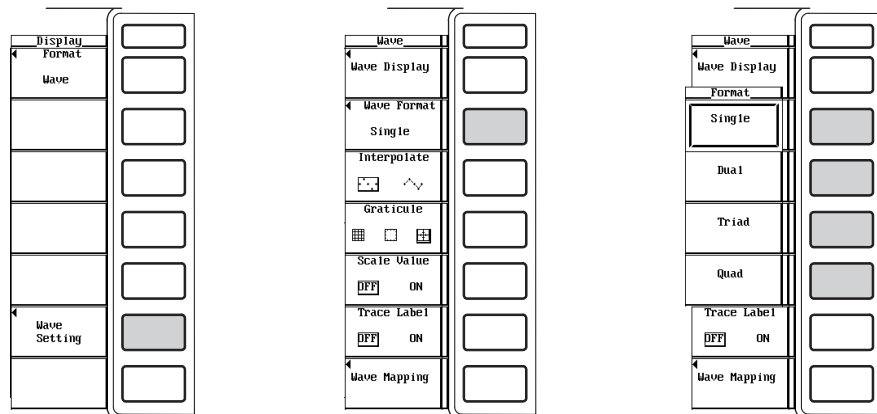

### 9.3 Splitting the Screen and Displaying the Waveforms

#### Selecting the waveform mapping

6. Press the [Wave Mapping] soft key to display the waveform mapping selection box.  
On products (PZ4000) with firmware version before 2.01, press the [Mapping] soft key to select [Auto] or [Fixed].
7. Turn the jog shuttle to select [Mode].
8. Press the SELECT key to select [Auto], [Fixed], or [User]. If you select "User," proceed to step 9.
9. Turn the jog shuttle to select the desired channel.
10. Press the SELECT key to display the display position number selection box.
11. Turn the jog shuttle to select the position from [0] to [3].
12. Press the SELECT key to confirm the new display position.

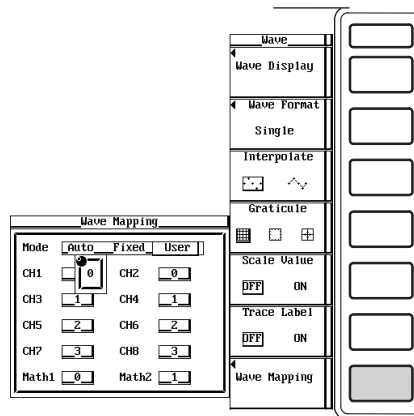

**Explanation**

The screen can be evenly divided and the waveform corresponding to each channel can be assigned to one of the divided windows.

**Selecting the number of divisions**

Select the number of divisions from the following list of choices.

- Single : No division
- Dual : Two divisions
- Triad : Three divisions
- Quad : Four divisions

Depending on the number of divisions, the number of displayed points in the vertical direction varies as follows. The display resolution of sampled data, such as the voltage level, does not change (see section 1.6).

Single : 432 points, Dual : 216 points, Triad : 144 points, Quad : 108 points

**Waveform mapping**

- Auto  
The waveforms of CH1, CH2, ..., Math1, Math2 are assigned in order from the top divided window. The channels that are turned OFF are skipped.
- Fixed  
The channels that are turned OFF are also assigned to the windows. Math1 and Math2 are displayed in the top window and 2nd window, respectively.

**When the screen is divided into four windows [Quad], CH1 through CH6, CH8, and Math2 are ON, and CH7 and Math1 are OFF.**

**Auto**

CH1, CH5
CH2, CH6
CH3, CH8
CH4, Math2

**Fixed**

CH1, CH5
CH2, CH6, Math2
CH3
CH4, CH8

- User  
The channels can be assigned arbitrarily to the divided windows regardless of whether or not the display is turned ON. You can select the display position from 0 to 3. The channels are assigned in order starting from number 0 from the top divided window. This is applicable to products (PZ4000) with firmware version 2.01 or later.

**User (when the screen is divided into three windows with CH2, Math1, and Math2 set to 0, 1, and 3, respectively)**

CH2, Math2	0, 3
Math1	1
	2

The channels are displayed in order according to the specified number.

# 9.4 Interpolating the Display

«For a functional description, see section 1.6.»

## Keys

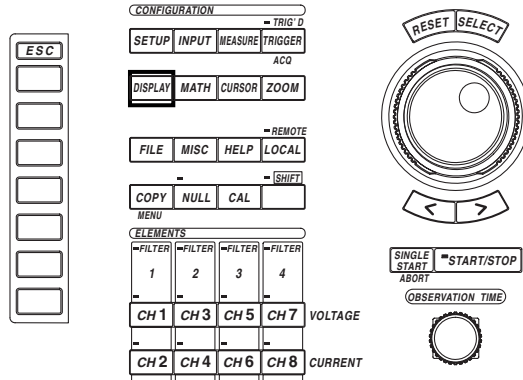

- The  mark indicates the keys that are used for the operation.
- To exit the menu during operation, press the ESC key.

## Procedure

Select a display format to display the waveforms. For the procedures, see section 9.1, “Selecting the Channel to Display.”

1. Press the DISPLAY key to display the Display setting menu.
  2. Press the [Format] soft key to display the display format selection box. Check that [Format] is set to [Wave], [Numeric+Wave], [Wave+Bar], or [Wave+X-Y]\*.
- \* X-Y waveform display is applicable to products (PZ4000) with firmware version 2.01 or later.

The following procedures are given with the premise that the display format is set to [Wave].

3. Press the [Wave Setting] soft key to display the waveform menu.
4. Press the [Interpolate] soft key to select [ $\cdot\cdot\cdot$ ] or [ $\wedge\vee$ ].

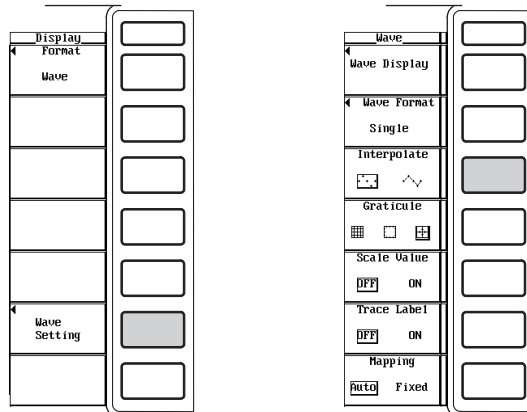

**Explanation**

When there are less than 500 points of sampled data on the time axis, the area between the display points (rasters) is no longer continuous. This function interpolates between the points so that the waveform appears to be connected. Select the interpolation mode from the following choices.

- 

No interpolation

- When there are 500 points or more of sampled data

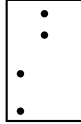

- When there are less than 500 points of sampled data

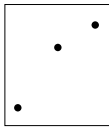

- 

Linearly interpolate between two points

- When there are 500 points or more of sampled data  
Connects the dots vertically.

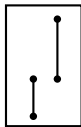

- When there are less than 500 points of sampled data



## 9.5 Changing the Graticule

### Keys

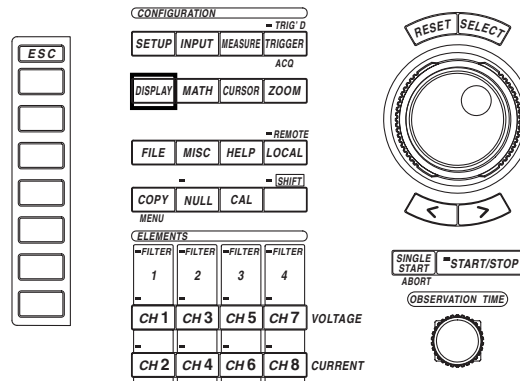

- The   mark indicates the keys that are used for the operation.
- To exit the menu during operation, press the ESC key.

### Procedure

Select a display format to display the waveforms. For the procedures, see section 9.1, “Selecting the Channel to Display.”

1. Press the DISPLAY key to display the Display setting menu.
  2. Press the [Format] soft key to display the display format selection box. Check that [Format] is set to [Wave], [Numeric+Wave], [Wave+Bar], or [Wave+X-Y]\*.
- \* X-Y waveform display is applicable to products (PZ4000) with firmware version 2.01 or later.

The following procedures are given with the premise that the display format is set to [Wave].

3. Press the [Wave Setting] soft key to display the waveform menu.
4. Press the [Graticule] soft key to select  ,  , or  .

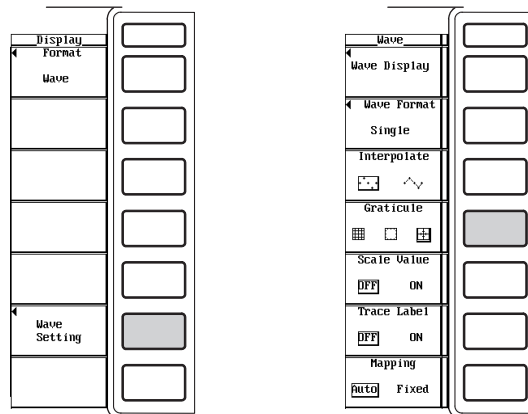



**Explanation**

Select the grid or cross scale to display on the screen from the following list of choices.

- 

Grid display

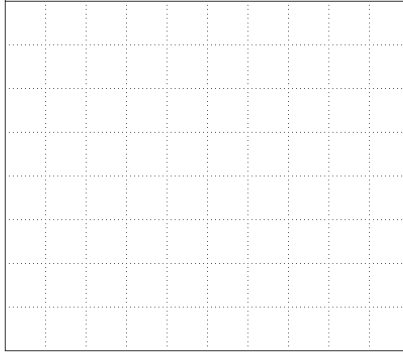

- 

No grid or cross scale display

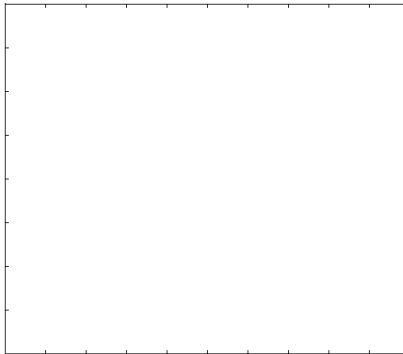

- 

Cross scale display

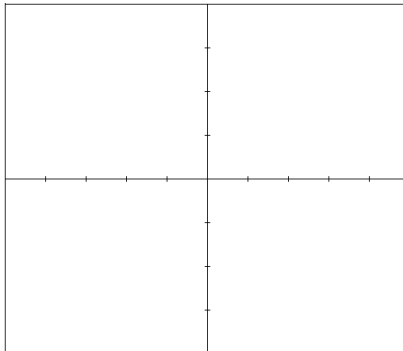

## 9.6 Turning ON/OFF the scale display

### Keys

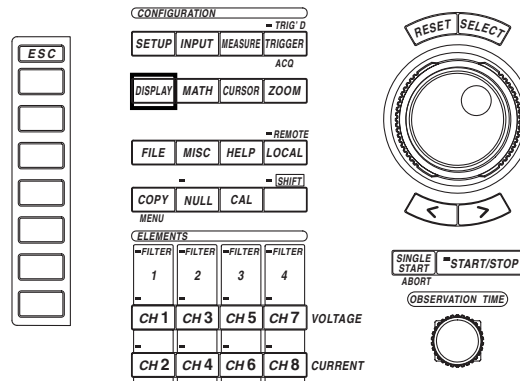

- The   mark indicates the keys that are used for the operation.
- To exit the menu during operation, press the ESC key.

### Procedure

Select a display format to display the waveforms. For the procedures, see section 9.1, “Selecting the Channel to Display.”

1. Press the DISPLAY key to display the Display setting menu.
2. Press the [Format] soft key to display the display format selection box. Check that [Format] is set to [Wave], [Numeric+Wave], [Wave+Bar], or [Wave+X-Y]\*.

\* X-Y waveform display is applicable to products (PZ4000) with firmware version 2.01 or later.

The following procedures are given with the premise that the display format is set to [Wave].

3. Press the [Wave Setting] soft key to display the waveform menu.
4. Press the [Scale Value] soft key to select [ON] or [OFF].

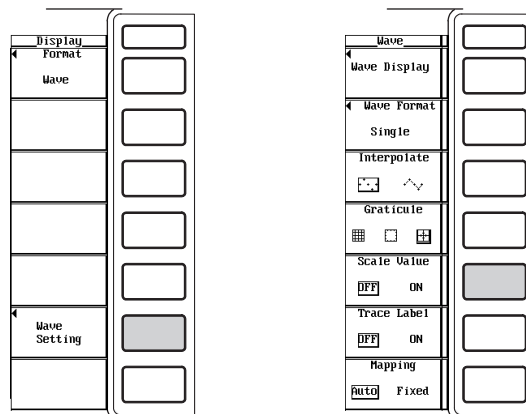

### Explanation

You can select whether or not to display (ON/OFF) the upper and lower limits of the vertical axis of each channel and the values at the left and right ends of the horizontal axis (time axis).

- ON: Displays the scale values.
- OFF: Does not display the scale values.

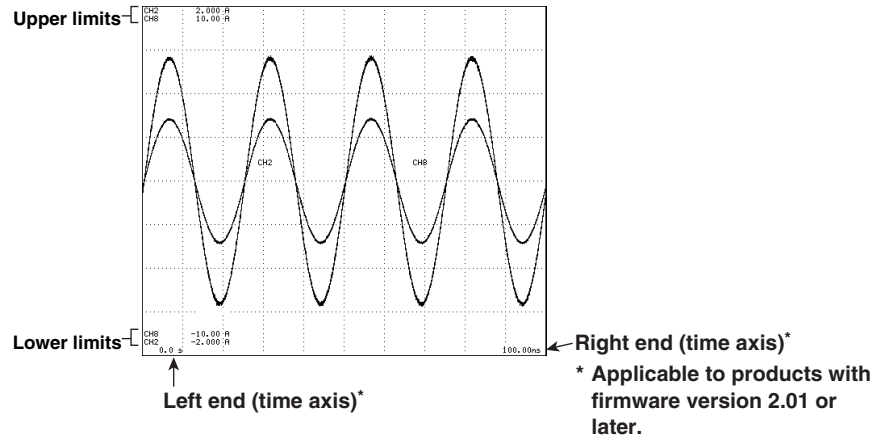

## 9.7 Setting a Label Name for the Waveform

### Keys

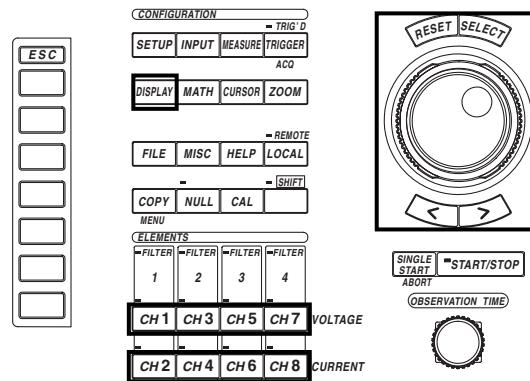

- The  mark indicates the keys that are used for the operation.
- To exit the menu during operation, press the ESC key.

### Procedure

#### Setting the label name

1. Press the desired channel key from CH1 to CH8. The channel setting menu is displayed.
2. Press the [Label] soft key. A keyboard appears.
3. Use the keyboard to enter the label name.

For keyboard operation, see section 4.1, "Entering Values and Strings."

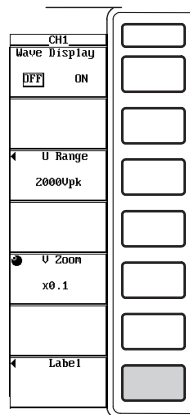

Select a display format to display the waveforms. For the procedures, see section 9.1, “Selecting the Channel to Display.”

4. Press the DISPLAY key to display the Display setting menu.
5. Press the [Format] soft key to display the display format selection box. Check that [Format] is set to [Wave], [Numeric+Wave], [Wave+Bar], or [Wave+X-Y].  
 \* X-Y waveform display is applicable to products (PZ4000) with firmware version 2.01 or later.

The following procedures are given with the premise that the display format is set to [Wave].

**Turning ON/OFF the label name**

6. Press the [Wave Setting] soft key to display the waveform menu.
7. Press the [Trace Label] soft key to select [ON] or [OFF].

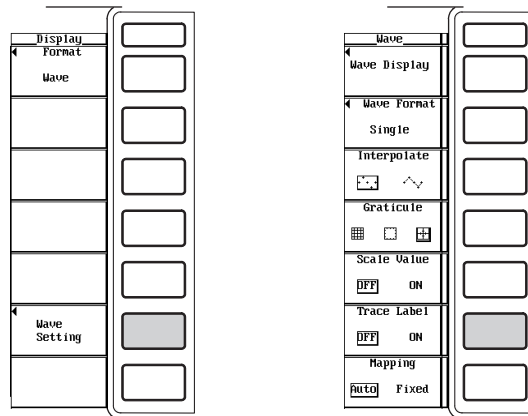

**Explanation**

**Setting the label name**

Set the label name of each channel using eight characters or less.

**Turning ON/OFF the label name**

Select whether or not to display the label name (channel name) of the waveform.

- ON : Displays the label name.
- OFF : Does not display the label name.

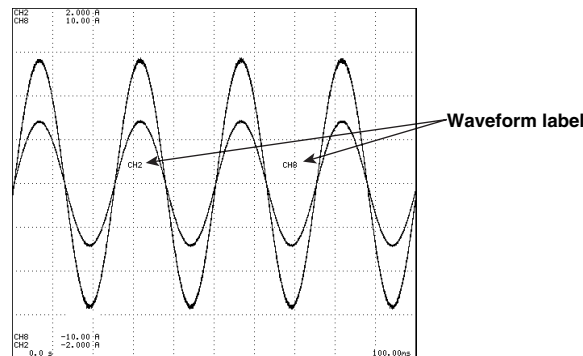

## 9.8 Zooming on the Waveform

«For a functional description, see section 1.6.»

### Keys

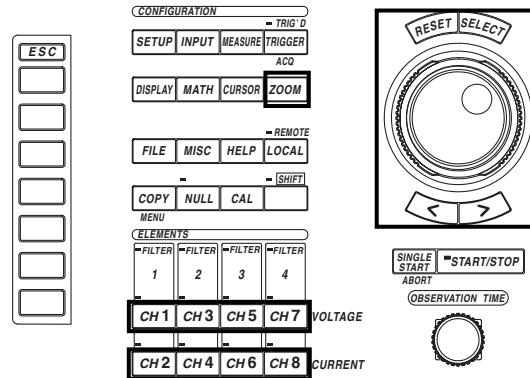

- The  mark indicates the keys that are used for the operation.
- To exit the menu during operation, press the ESC key.

### Procedure

Select a display format to display the waveforms. For the procedures, see section 9.1, “Selecting the Channel to Display.”

1. Press the DISPLAY key to display the Display setting menu.
  2. Press the [Format] soft key to display the display format selection box. Check that [Format] is set to [Wave], [Numeric+Wave], [Wave+Bar], or [Wave+X-Y]\*.
- \* X-Y waveform display is applicable to products (PZ4000) with firmware version 2.01 or later.

The following procedures are given with the premise that the display format is set to [Wave].

### Zooming vertically

3. Press the desired channel key from CH1 to CH8. The channel setting menu is displayed.
4. Press the [V Zoom] soft key.
5. Turn the jog shuttle to set the zoom factor.

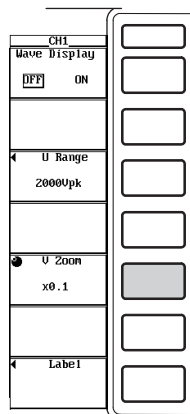

## Zooming horizontally

### Selecting the type of zoom display

3. Press the ZOOM key to display the Zoom setting menu.
4. Press the [Mode] soft key to display the menu used to select the type of zoom display.
5. Press one of the soft keys from [Main] to [Z1&Z2] to select the type of zoom display.

### Selecting the number of split windows in the zoom display region

6. Press the [Zoom Format] soft key to display the menu used to select the number of split windows in the zoom display region.
7. Press one of the soft keys from [Main] to [Quad] to select the number of windows.

### Selecting the waveform to zoom

8. Press the [Allocation] soft key to display the zoom waveform selection box.

- **Selecting whether or not to zoom on each waveform (ON/OFF)**

9. Turn the jog shuttle to select the desired channel.
10. Press the SELECT key. When the button to the left of the channel in the zoom waveform display selection box is highlighted, the waveform will be zoomed. If it is not highlighted, the waveform will not be zoomed. Go to step 13.

- **Selecting/deselecting all waveforms to zoom (ON/OFF)**

#### Selecting all waveforms

9. Turn the jog shuttle to select [All ON].
10. Press the SELECT key. All the buttons to the left of the channels in the zoom waveform display selection box are highlighted and all waveforms are selected.

#### Deselecting all waveforms

11. Turn the jog shuttle to select [All OFF].
12. Press the SELECT key. All the buttons to the left of the channels in the zoom waveform display selection box are no longer highlighted and all waveforms are deselected.

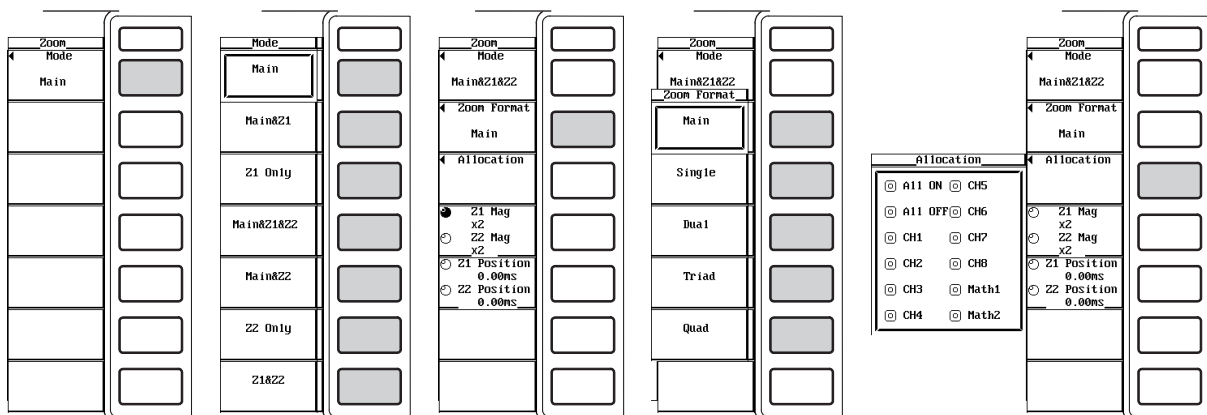

## 9.8 Zooming on the Waveform

### Setting the zoom factor

13. Press the [Z1 Mag] and [Z2 Mag] soft keys so that the jog shuttle controls [Z1 mag], [Z2 Mag], or both [Z1 Mag] and [Z2 Mag]. To control both [Z1 Mag] and [Z2 Mag], you must have selected Z1 and Z2 in the previous section, "Selecting the type of zoom display."
14. Turn the jog shuttle to set the zoom factor.

### Setting the zoom position

15. Press the [Z1 Position] and [Z2 Position] soft keys so that the jog shuttle controls [Z1 Position], [Z2 Position], or both [Z1 Position] and [Z2 Position]. To control both [Z1 Position] and [Z1 Position], you must have selected Z1 and Z2 in the previous section, "Selecting the type of zoom display."
16. Turn the jog shuttle to set the zoom position.

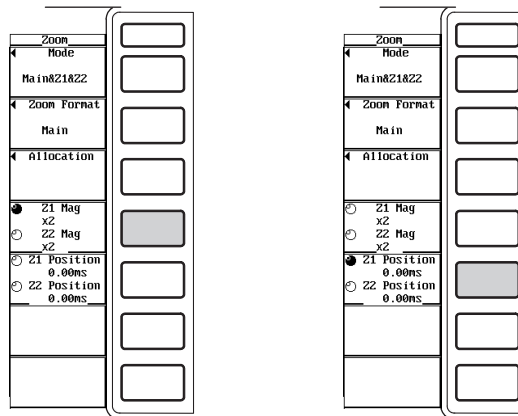



**Explanation****Zooming Vertically**

The displayed waveform of each channel can be expanded or reduced. Select the zoom factor from the following choices.

0.1, 0.2, 0.25, 0.4, 0.5, 0.75, 0.8, 1, 1.14, 1.25, 1.33, 1.41, 1.5, 1.6, 1.77, 2, 2.28, 2.66, 2.83, 3.2, 3.54, 4, 5, 8, 10, 12.5, 16, 20, 25, 40, 50, 100

**Zooming Horizontally**

All selected waveforms can be expanded horizontally (time axis) using two types of zoom factors.

**Selecting the type of zoom display**

The Main waveform that is not zoomed and the zoomed waveforms (Z1 and Z2 waveforms) can be displayed in the following combinations.

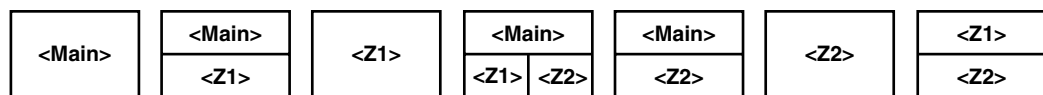

- **Main**  
Displays only the Main waveform that is not zoomed.
- **Main&Z1**  
Displays the Main waveform in the top section and the zoomed version of the waveform inside zoom box Z1, in the lower section.
- **Z1 Only**  
Displays only the zoomed version of the waveform inside zoom box Z1.
- **Main&Z1&Z2**  
Displays the Main waveform in the top section. Displays the zoomed versions of the waveforms inside zoom boxes Z1 and Z2, in the lower left and lower right sections respectively.
- **Main&Z2**  
Displays the Main waveform in the top section and the zoomed version of the waveform inside zoom box Z2, in the lower section.
- **Z2 Only**  
Displays only the zoomed version of the waveform inside zoom box Z2.
- **Z1&Z2**  
Displays the zoomed versions of the waveforms inside zoom boxes Z1 and Z2, in the top and bottom sections respectively.

**Selecting the number of split windows in the zoom display region**

The zoom display regions, Z1 and Z2, can be evenly divided and each waveform can be assigned to each divided window. Select the number of split windows from the following list of choices.

- **Main** : The number of windows selected in [Wave Format] in section 9.3, “Splitting the Screen and Displaying the Waveforms” becomes effective.
- **Single** : No division
- **Dual** : Two divisions
- **Triad** : Three divisions
- **Quad** : Four divisions

The assigning of the zoom waveforms follows the setting that was specified in [Mapping] in section 9.3, “Splitting the Screen and Displaying the Waveforms.”

## 9.8 Zooming on the Waveform

### Selecting the waveform to zoom

Select the waveform to zoom from the following choices.

CH1 to CH8, Math1, Math2

However, the waveforms that are turned OFF according to the settings described in section 9.1, "Selecting the Channel to Display" cannot be zoomed.

### Setting the zoom factor

- The maximum zoom factor that can be selected depends on the display record length and observation time. For example, the maximum zoom factor is 10,000 times when the observation time is 20 s and the display record length is 100 k-words. It is 100,000 times when the observation time is 20 s and the display record length is 1 M-word or 4 M-words. The maximum zoom factor becomes smaller as the display record length gets shorter.
- You can select different zoom factors for Z1 and Z2 (the two zoom sections).
- When there are less than 500 points of sampled data on the time axis because the display record length is less than the number of displayed points or the waveform is expanded too much, the display points are interpolated.
- To set the zoom factors of Z1 and Z2 simultaneously, Z1 and Z2 must both be selected as described in the previous section, "Selecting the type of zoom display."

Observation Time	Maximum Zoom Factor along the Time Axis						Selectable Steps
	When the record length is not divided (When [Rec Division] is turned OFF in the ACQ menu)			When the record length is divided (When [Rec Division] is turned ON in the ACQ menu)			
	Record Length			Record Length			
	100 k-words	1 M-Word (option)	4 M-Words (option)	100 k-words	1 M-Word (option)	4 M-Words (option)	
1 ks	×10000	×100000	×100000	×5000	×50000	×100000	1-2.5-5 steps
400 s	×10000	×100000	×100000	×2000	×20000	×100000	1-2.5-5 steps
200 s	×10000	×100000	×100000	×5000	×50000	×100000	1-2.5-5 steps
100 s	×10000	×100000	×100000	×5000	×50000	×100000	1-2.5-5 steps
40 s	×10000	×100000	×100000	×2000	×20000	×100000	1-2.5-5 steps
20 s	×10000	×100000	×100000	×5000	×50000	×100000	1-2.5-5 steps
10 s	×10000	×100000	×100000	×5000	×50000	×100000	1-2.5-5 steps
4 s	×10000	×100000	×100000	×2000	×20000	×100000	1-2.5-5 steps
2 s	×10000	×100000	×100000	×5000	×50000	×100000	1-2.5-5 steps
1 s	×10000	×100000	×100000	×5000	×50000	×50000	1-2.5-5 steps
400 ms	×10000	×100000	×100000	×2000	×20000	×100000	1-2.5-5 steps
200 ms	×10000	×100000	×100000	×5000	×50000	×100000	1-2.5-5 steps
100 ms	×10000	×50000	×50000	×5000	×50000	×50000	1-2.5-5 steps
40 ms	×10000	×20000	×20000	×2000	×20000	×20000	1-2.5-5 steps
20 ms		×10000		×5000	×10000	×10000	1-2.5-5 steps
10 ms		×5000			×5000		1-2.5-5 steps
4 ms		×2000			×2000		1-2.5-5 steps
2 ms		×1000			×1000		1-2.5-5 steps
1 ms		×500			×500		1-2.5-5 steps
400 μs		×200			×200		1-2.5-5 steps
200 μs		×100			×100		1-2.5-5 steps
100 μs		×50			×50		1-2.5-5 steps
40 μs		×20			×20		1-2.5-5 steps
20 μs		×10			×10		1-2.5-5 steps
10 μs		×5			×5		1-2.5-5 steps

**Setting the zoom position**

- When the measurement mode is normal and the time base is set to internal clock, the zoom position is set in units of time. When the time base is set to external clock or when the measurement mode is harmonic, the zoom position is set in units of data point. If the Main waveform and the Z1 or Z2 waveforms are displayed simultaneously, a zoom box indicating the zoom position appears in the display frame of the Main waveform. Thus, the zoom position can be checked.
- When the measurement mode is normal and the time base is set to internal clock, the zoom box can be moved in the range from 0 s (the left end of the screen) to the observation time (the right end of the screen). When the time base is set to external clock or when the measurement mode is harmonic, the zoom box can be moved in the range defined by the number of data points in the record length. For example, if the record length is 100 k-words, then the range is from data point 0 (the left end of the screen) to data point 100 k (the right end of the screen).
- The center of the zoom box indicates the center of the zoomed waveform.
- When the measurement mode is normal and the time base is set to internal clock, the zoom position can be set in steps of  $(\text{observation time} \div \text{display record length})$ . When the time base is set to external clock or when the measurement mode is harmonic, the zoom position can be set in steps of one data point.
- The zoom box enclosed with a solid line is Z1; the zoom box enclosed with a dotted line is Z2. The zoom positions of Z1 and Z2 can be set independently.
- To set the positions of Z1 and Z2 simultaneously, keeping the distance between them constant, Z1 and Z2 must both be selected as described in the previous section, "Selecting the type of zoom display."

## 9.9 Displaying the Vectors of the Harmonics

«For a functional description, see section 1.6.»

This section applies when the measurement mode is set to harmonic measurement.

### Keys

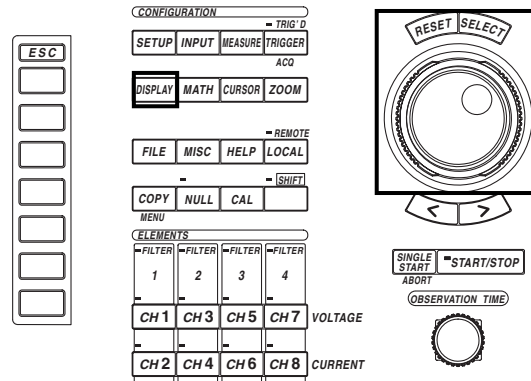

- The  mark indicates the keys that are used for the operation.
- To exit the menu during operation, press the ESC key.

### Procedure

Set the measurement mode to harmonic measurement. For the procedures, see section 5.1, “Selecting the Measurement Mode.”

1. Press the SETUP key to display the Setup menu. Confirm that [Mode] is set to [Harmonics].
2. Press the DISPLAY key to display the Display setting menu.
3. Press the [Format] soft key to display the display format selection box.

#### Displaying the vectors

4. Turn the jog shuttle to select [Vector].
5. Press the SELECT key to confirm the selection.

#### Select whether or not to display the numerical data (ON/OFF)

6. Press the [Numeric] soft key to select [ON] or [OFF].

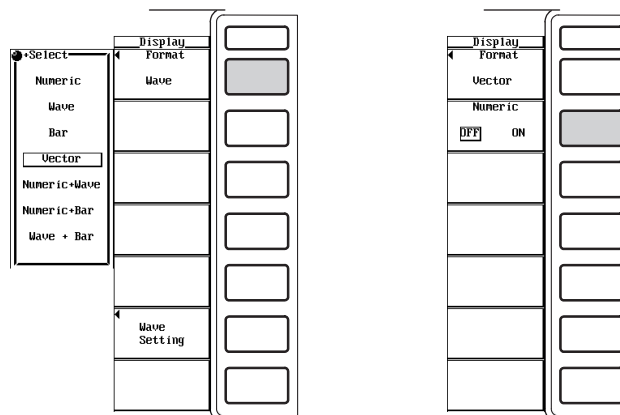

**Zooming in on the vector**

(This is applicable to products (PZ4000) with firmware version 2.01 or later.)

7. Press the [U Mag] or [I Mag] soft key to set the jog shuttle control to [U Mag], [I Mag], or both [U Mag] and [I Mag].
8. Turn the jog shuttle to set the zoom factor.

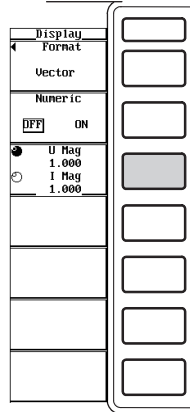
**Explanation**

Vector display is possible during harmonic measurement mode.

**Selecting the display format**

Select [Vector] to set the vector display. The phase difference and the amplitude (rms) relationships between the fundamental signal U(1) and the I(1) of the element wired using wiring method A can be displayed as vectors. The vector of each input signal is displayed with the positive vertical axis representing zero degrees.

**Turning ON/OFF the numerical data display**

Select whether or not to display the numerical data. The values of the amplitude and the phase difference between the signals can be displayed along with the vectors. For information pertaining to the display format of the phase difference, see section 10.6, "Selecting the Display Format of the Phase Difference."

- ON : Displays the numerical data.
- OFF : Does not display the numerical data.

**Setting the zoom factor of the vector**

The size of the vectors can be changed. This is applicable to products (PZ4000) with firmware version 2.01 or later.

- The zoom factor can be set in the range from 0.100 to 100.000.
- You can specify separate zoom factors for the fundamental waves U(1) and I(1).

## 9.9 Displaying the Vectors of the Harmonics

When displaying numerical data (the size of the signal and the phase difference between signals)

For a 3P4W (three-phase four-wire) wiring system

U1(1), U2(1), and U3(1) are common mode voltages.

I1(1), I2(1), and I3(1) are line currents.

For a 3V3A (three-voltage, three-current) wiring system

U1(1), U2(1), and U3(1) are line voltages.

I1(1), I2(1), and I3(1) are line currents.

For a 3P3W (three-phase three-wire) wiring system

U1(1), U2(1), and U3(1) are line voltages.

I1(1), I2(1), and I3(1) are line currents.

However, U3(1) and I3(1) are not actually measured for the three-phase three-wire method. The vectors are displayed through computation.

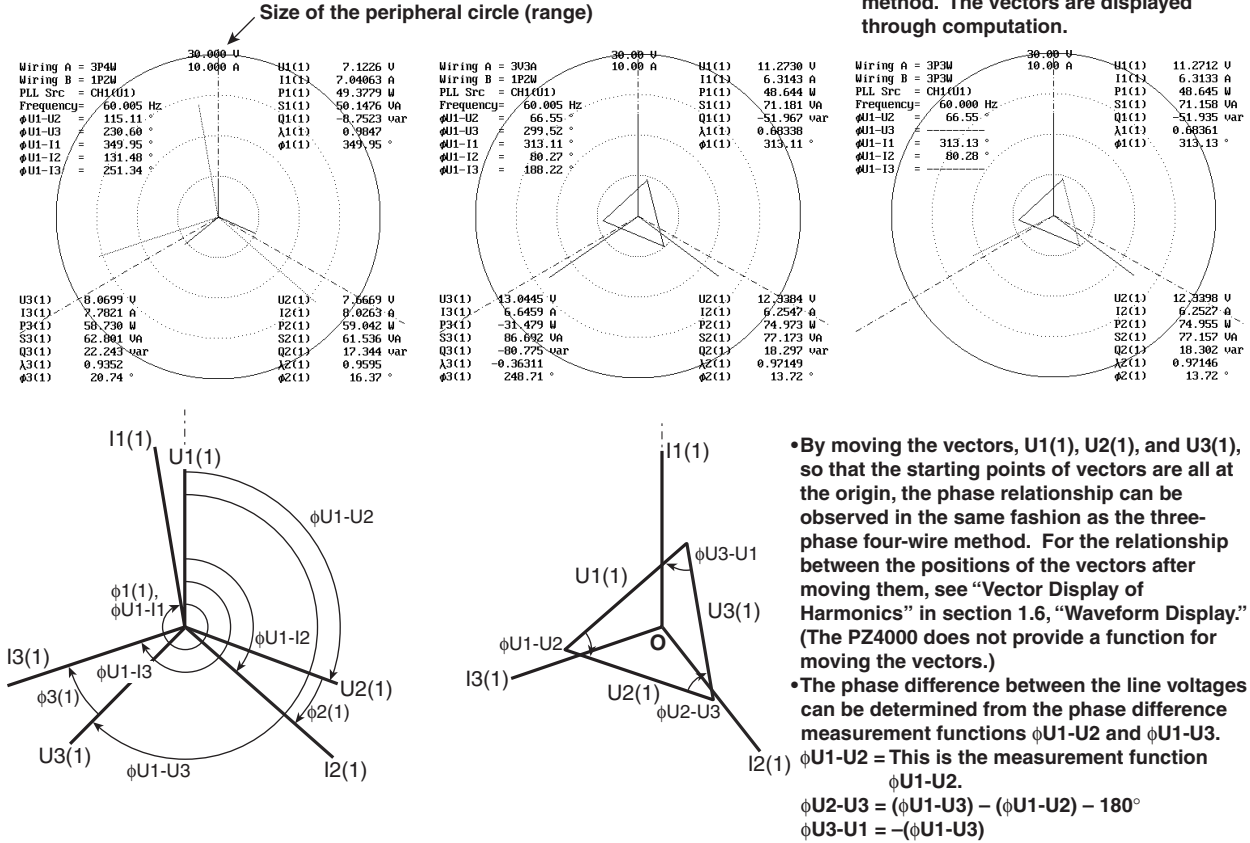

When not displaying numerical data, and when the vector size is displayed zoomed

(applicable to products with firmware version 2.01 or later)

See “Vector display of harmonics” in section 2.3, “Screens.”

## 9.10 Displaying the Bar Graph of Harmonic Data

«For a functional description, see section 1.6.»

This section applies when the measurement mode is set to harmonic measurement.

### Keys

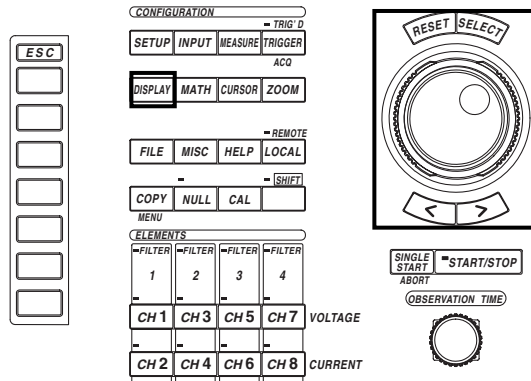

- The  mark indicates the keys that are used for the operation.
- To exit the menu during operation, press the ESC key.

### Procedure

Set the measurement mode to harmonic measurement. For the procedures, see section 5.1, “Selecting the Measurement Mode.”

1. Press the SETUP key to display the Setup menu. Confirm that [Mode] is set to [Harmonics].
2. Press the DISPLAY key to display the Display setting menu.
3. Press the [Format] soft key to display the display format selection box.

### Displaying the bar graph

- **Displaying only the bar graphs**
4. Turn the jog shuttle to select [Bar].
  5. Press the SELECT key to confirm the selection. Two bar graphs are displayed.

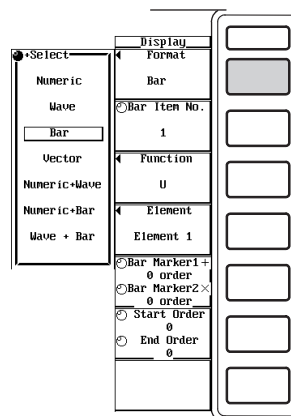

## 9.10 Displaying the Bar Graph of Harmonic Data

- **Displaying numerical data and the bar graphs**

4. Turn the jog shuttle to select [Numeric+Bar].
5. Press the SELECT key to confirm the selection. Two bar graphs are displayed.  
For the procedures related to setting the numerical display, see chapter 8.

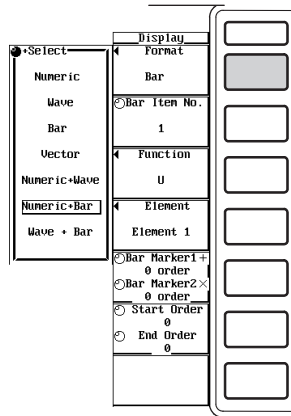

- **Displaying the waveform and the bar graphs**

4. Turn the jog shuttle to select [Wave+Bar].
5. Press the SELECT key to confirm the selection. Two bar graphs are displayed.  
For the procedures related to setting the waveform display, see sections 9.1 to 9.8.

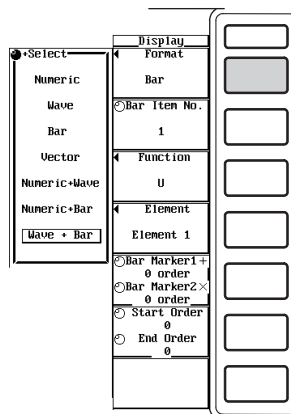



The following procedures are given with the premise that “Displaying the waveform and the bar graphs” was selected in the previous paragraph.

6. Press the [Bar Setting] soft key to display the Bar menu.

**Selecting the bar graph to be configured**

7. Press the [Bar Item No.] soft key.
8. Turn the jog shuttle to select [1] or [2]. [1] represents the bar graph displayed at the top of the bar graph display region. [2] represents the bar graph displayed at the bottom of the bar graph display region.

**Selecting the measurement function**

9. Press the [Function] soft key to display the measurement function selection box.
10. Turn the jog shuttle to select the measurement function.
11. Press the SELECT key. The symbol of the selected measurement function and the bar graph are displayed.

**Selecting the element**

12. Press the [Element] soft key to display the element selection box.
13. Turn the jog shuttle to select the element from [Element1] to [Element4].
14. Press the SELECT key. The symbol of the selected element and the bar graph are displayed.

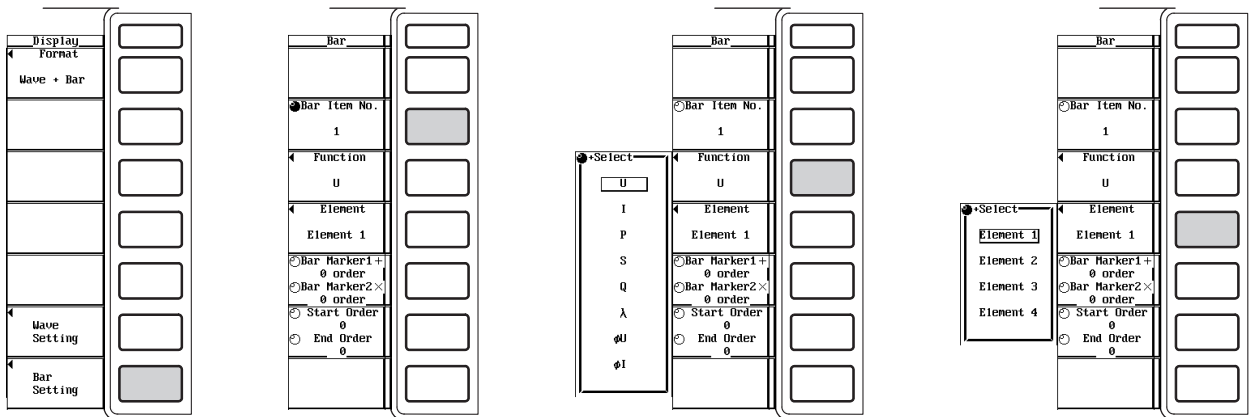

## 9.10 Displaying the Bar Graph of Harmonic Data

### Setting the marker position

15. Press the [Bar Marker1+ / Bar Marker2×] soft key to set the jog shuttle control to [Bar Marker1+], [Bar Marker2×], or both [Bar Marker1+] and [Bar Marker2×].
16. Turn the jog shuttle to set the marker position in terms of harmonic orders.

### Setting the bar graph display range

- **Setting the beginning harmonic order of the bar graph**

17. Press the [Start Order / End Order] soft key to set the jog shuttle control to [Start Order].
18. Turn the jog shuttle to set the beginning harmonic order of the bar graph.

- **Setting the last harmonic order of the bar graph**

19. Press the [Start Order / End Order] soft key to set the jog shuttle control to [End Order].
20. Turn the jog shuttle to set the last harmonic order of the bar graph.

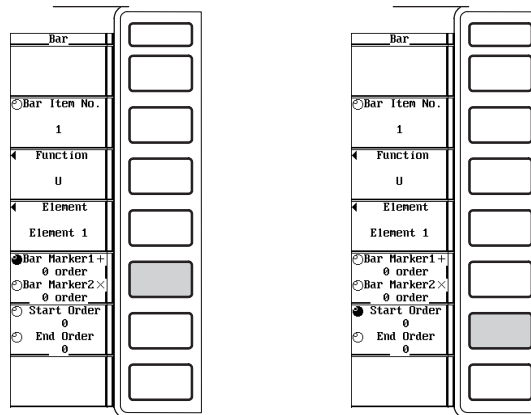

**Explanation**

With the harmonic order assigned to the horizontal axis and the amplitude of the harmonics assigned to the vertical axis, the amplitudes of the harmonics can be displayed using a bar graph.

**Selecting the display format**

Select the display format of the bar graph from the following list of choices.

- Bar  
Displays only the bar graph.
- Numeric+Bar  
The numerical data and the bar graph are displayed separately in the top and bottom windows. For the procedures related to setting the numerical display, see chapter 8.
- Wave+Bar  
The waveform and the bar graph are displayed separately in the top and bottom windows. For the procedures related to setting the waveform display, see sections 9.1 to 9.8.

**Selecting the bar graph to be configured**

Two bar graphs can be configured. Select either [1] (bar graph 1) or [2] (bar graph 2).

**Selecting the measurement function**

Select the measurement function from the following choices.

U, I, P, S, Q,  $\lambda$ ,  $\phi$ ,  $\phi U$ ,  $\phi I$ , Z, Rs, Xs, Rp, Xp, Torque\*

\* This is applicable to products (PZ4000) with firmware version 2.01 or later when the motor module is installed in the element number 4 slot.

**Selecting the element**

Select the element from the following choices.

Element1, Element2, Element3, Element4

The measurement function [Torque] is applicable only to products (PZ4000) with firmware version 2.01 or later when the motor module installed in the element number 4 slot. Therefore, the selected element is set to some measurement function other than [Torque].

**Setting the marker position**

- Two markers (+ and  $\times$ ) are displayed in each graph (bar graphs 1 and 2).
- The marker position can be set in terms of harmonic orders.
- Bar graph 2 displays the harmonic order that indicates the marker position.
- The position of the + marker of graph 1 is the same as the position of that of graph 2. The same holds true for the  $\times$  marker.
- The minimum value is 0th order (dc). However, if the measurement function is set to  $\phi$ ,  $\phi U$ , or  $\phi I$ , there is no value for the 0th order. Thus, no bar is displayed there.
- The maximum value is the upper limit of the harmonic analysis. The upper limit is determined automatically (maximum is 500) by the frequency of the PLL source. For details, see section 17.5.
- To set the markers of bar graph 1 and 2 simultaneously to the same harmonic order, the jog shuttle must be set to control both [Bar Marker1+] and [Bar Marker2 $\times$ ].

**Setting the bar graph display range**

- Set the range of the bar graph in terms of harmonic orders.
- The bar graph display range of bar graphs 1 and 2 are the same.
- The minimum value is 0th order (dc). However, if the measurement function is set to  $\phi$ ,  $\phi U$ , or  $\phi I$ , there is no value for the 0th order. Thus, no bar is displayed there.
- The maximum value is the upper limit of the harmonic analysis. The upper limit is determined automatically (maximum is 500) by the frequency of the PLL source. For details, see section 16.5.

# 9.11 Displaying the X-Y Waveform

«For a functional description, see section 1.6.»

## Keys

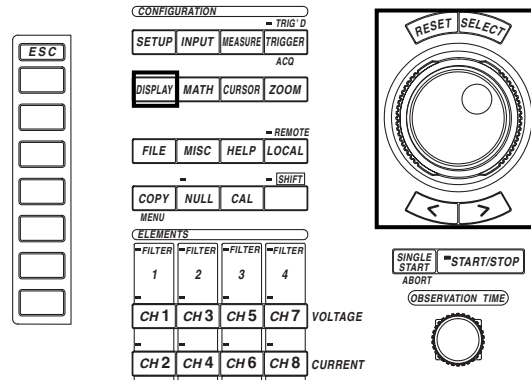

- The  mark indicates the keys that are used for the operation.
- To exit the menu during operation, press the ESC key.

## Procedure

1. Press the DISPLAY key to display the Display setting menu.
2. Press the [Format] soft key to display the display format selection box.

### Displaying the X-Y waveform

X-Y waveform display is applicable to products (PZ4000) with firmware version 2.01 or later.

- **Displaying only the X-Y waveform**
4. Turn the jog shuttle to select [X-Y].
  5. Press the SELECT key to confirm the selection.

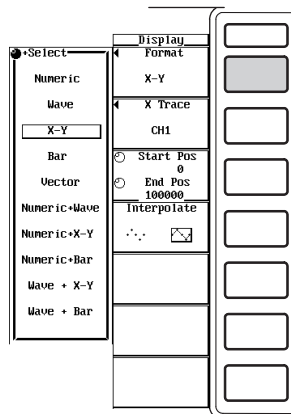

• **Displaying numerical data and X-Y waveform**

4. Turn the jog shuttle to select [Numeric+X-Y].
5. Press the SELECT key to confirm the selection.

For the procedures related to setting the numerical display, see chapter 8.

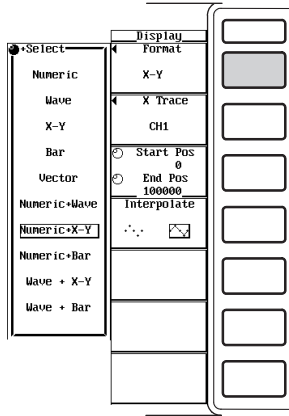

• **Displaying waveform and X-Y waveform**

4. Turn the jog shuttle to select [Wave+X-Y].
5. Press the SELECT key to confirm the selection.

For the procedures related to setting the waveform display, see sections 9.1 to 9.8.

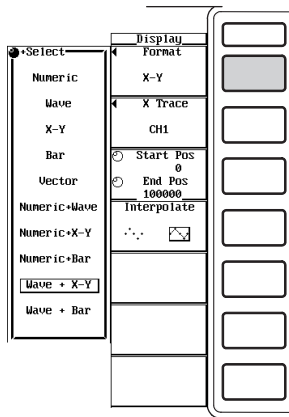

## 9.11 Displaying the X-Y Waveform

The following procedures are given with the premise that “Displaying waveform and X-Y waveform” was selected in the previous section.

6. Press the [X-Y Setting] soft key to display the X-Y menu.

### Selecting the X-axis (horizontal axis)

7. Press the [X Trace] soft key to display the X-axis selection box.
8. Turn the jog shuttle to select the X-axis from [CH1] to [Math2].
9. Press the SELECT key to confirm the new X-axis.

### Setting the display range of the X-Y waveform

#### • Setting the start position

10. Press the “Start Pos / End Pos” soft key to set the jog shuttle control to [Start Pos].
11. Turn the jog shuttle to set the start position on the T-Y waveform.

#### • Setting the end position

12. Press the “Start Pos / End Pos” soft key to set the jog shuttle control to [End Pos].
13. Turn the jog shuttle to set the end position on the T-Y waveform.

#### • Setting the start and end positions simultaneously

14. Press the “Start Pos / End Pos” soft key to set the jog shuttle control to both [Start Pos] and [End Pos].
15. Turn the jog shuttle to set the display range of the X-Y waveform without changing the distance between the start and end positions.

### Setting the display interpolation

16. Press the [Interpolate] soft key to select [ $\cdot\cdot\cdot$ ] or [ $\wedge\vee$ ].

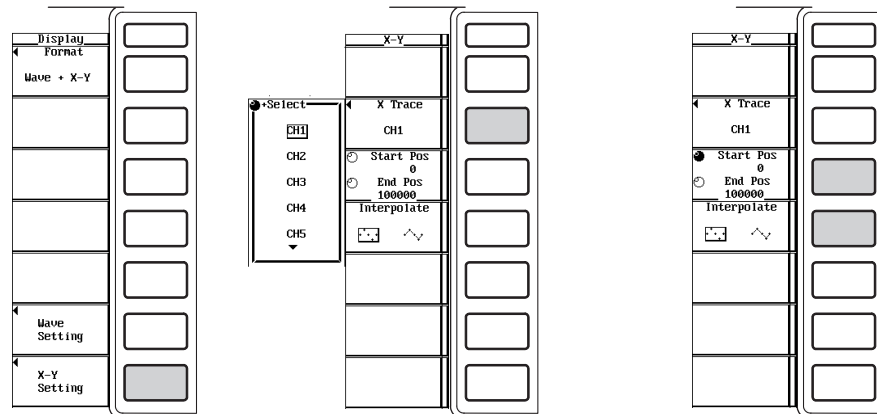

**Explanation**

The relationship between the amplitude levels between signals can be observed by assigning the amplitude of the input signal of the specified channel on the horizontal axis (X-axis) and the amplitude level of another input signal (signal that has the display turned ON) on the vertical axis (Y-axis). Simultaneous observation of an X-Y waveform and a normal T-Y waveform (waveform display using time axis and amplitude level). X-Y waveform display is applicable to products (PZ4000) with firmware version 2.01 or later.

**Selecting the display format**

Select the X-Y display format from the following list of choices:

- X-Y  
Only the X-Y waveform is displayed.
- Numeric+X-Y  
The numerical data and X-Y waveform are displayed separately in the top and bottom windows. For the procedures related to setting the numerical display, see chapter 8.
- Wave+X-Y  
The waveform (normal T-Y waveform) and X-Y waveform are displayed separately in the top and bottom windows. For the procedures related to setting the waveform display, see sections 9.1 to 9.8.

**Assigning the X-axis (horizontal axis) and Y-axis (vertical axis)**

- X-axis  
Specify any waveform trace (CH1 to CH8, Math1, and Math2).
- Y-axis  
Specify any waveform trace other than the one specified for the X-axis. The display of the waveform specified must be turned ON.

**Setting the display range of the X-Y waveform**

- The display range during the normal measurement mode when the time base is set to internal clock is specified in units of time. The display range when the time base is set to external clock or during the harmonic measurement mode is specified in units of data points. When the T-Y waveform and X-Y waveform are displayed simultaneously, the start position (dot-dashed line) and the end position (dotted line) are displayed within the display frame of the T-Y waveform. This allows you to check the display range of the X-Y waveform.
- The range of movement of the start and end positions during the normal measurement mode when the time base is set to internal clock is from 0 s (left end of the screen) to the observation time (right end of the screen). The range of movement of the start and end positions when the time base is set to external clock or during the harmonic measurement mode is the number of data points equal to the specified record length. For example, if the record length is set to 100 k-words, the range is from 0 (left end of the screen) to data point 100 k (right end of the screen).
- The resolution of the display range during the normal measurement mode when the time base is set to internal clock is equal to observation time ÷ display record length. The resolution of the display range when the time base is set to external clock or during the harmonic measurement mode is one data point.
- In order to move the start and end positions simultaneously without changing the distance between the two, the jog shuttle control must be set to both [Start Pos] and [End Pos].

## 9.11 Displaying the X-Y Waveform

---

### Setting the display interpolation



No interpolation is performed. Displays the X-Y waveform using all sampled data. Thus, if there are many data points within the display range of the X-Y waveform, it will take a long time to display the X-Y waveform.



Linearly interpolates between two points. Displays the X-Y waveform using the waveform display data obtained from P-P compressing the sampled data. When compared to the case when interpolation is not performed, the time it takes to display the X-Y waveform is shorter. This is because the number of data points that need to be displayed is less. However, the marker may appear at some position off the interpolated line during cursor measurements (section 11.4).

### Note

---

- The number of divisions of the T-Y waveform display when the T-Y waveform and X-Y waveform are displayed simultaneously take on the value specified by [Wave Format] in section 9.3, "Splitting the Screen and Displaying the Waveforms."
  - Zooming along the time axis is applicable only to the T-Y waveform display.
  - You can vertically zoom in on the X-Y waveform using the "V Zoom" soft key of the CH key.
-



# 10.1 Setting the Measurement/Computation Period, Re-computing

«For a functional description, see section 1.2.»

There are two methods available for setting the measurement/computation period. One method can only be used in the normal measurement mode. The other method can be used both in the normal measurement and harmonic measurement modes.

### Keys

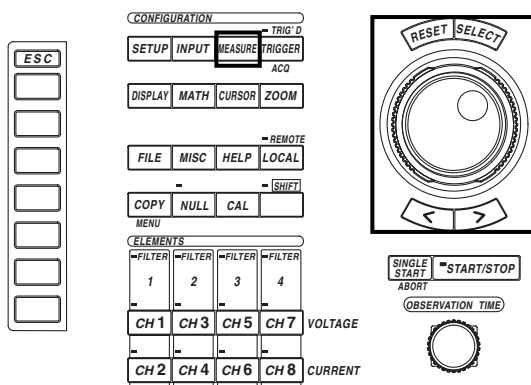

- The  mark indicates the keys that are used for the operation.
- To exit the menu during operation, press the ESC key.

### Procedure

Select a display format to display the waveforms. For the procedures, see section 9.1, “Selecting the Channel to Display.”

1. Press the DISPLAY key to display the Display setting menu.
2. Press the [Format] soft key to display the display format selection box. Check that [Format] is set to [Wave], [Numeric+Wave], [Wave+Bar], or [Wave+X-Y].
  - \* X-Y waveform display is applicable to products (PZ4000) with firmware version 2.01 or later.

The following procedures are given with the premise that the display format is set to [Wave].

#### Setting the period using zero crossing points

Set the measurement mode to normal measurement. For the procedures, see section 5.1, “Selecting the Measurement Mode.”

3. Press the SETUP key to display the Setup menu. Confirm that [Mode] is set to [Normal].

## 10.1 Setting the Measurement/Computation Period, Re-computing

4. Press the MEASURE key to display the Measure setting menu.
5. Press the [Mode] soft key to select [ON].
6. Press the [Period] soft key to display the period setting menu.
7. Press the [Zero Cross] soft key to select the zero crossing setting.

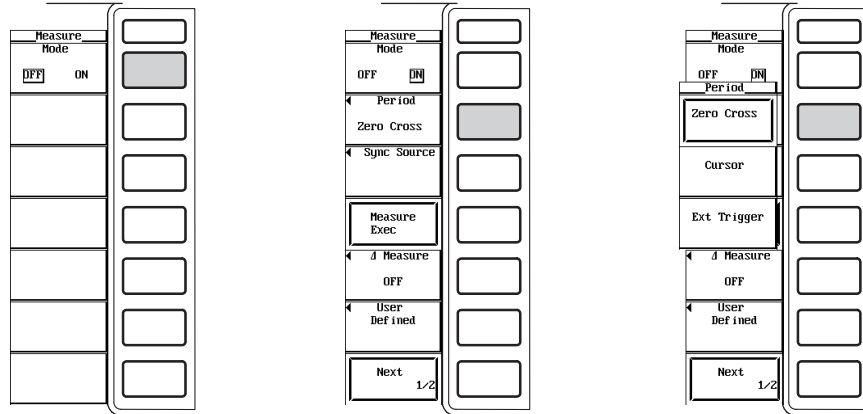

### • Selecting the synchronization source

8. Press the [Sync Source] soft key to display the element selection box.
9. Turn the jog shuttle to select the element from [Element1] to [Element4] to set the synchronization source.
10. Press the SELECT key to display the synchronization source selection box.
11. Turn the jog shuttle to select the source from [CH1] to [Ext Clk].
12. Press the SELECT key to confirm the selection.

Go to step 13 on page 10-5.

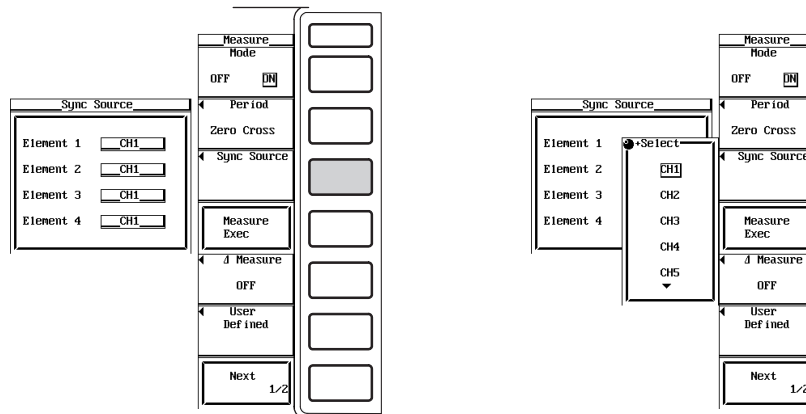

**Setting the period with the cursors**

This method can be used to set the period in the normal measurement and harmonic measurement modes.

For the normal measurement mode carry out steps 3 to 12. For the harmonic measurement mode, carry out steps 7 and 8.

3. Press the MEASURE key to display the Measure setting menu.
4. Press the [Mode] soft key to select [ON].
5. Press the [Period] soft key to display the period setting menu.
6. Press the [Cursor] soft key to select cursor setting.

• **Setting the start point of the measurement/computation period (For normal measurement and harmonic measurement modes)**

7. Press the [Start Pos / End Pos] soft key and set the jog shuttle control to [Start Pos]. For harmonic measurement mode, only the [Start Pos] soft key is available.
8. Turn the jog shuttle to set the start position on the waveform.

• **Set the end position of the measurement/computation period (For normal measurement mode only)**

9. Press the [Start Pos / End Pos] soft key to set the jog shuttle control to [End Pos].
10. Turn the jog shuttle to set the end position on the waveform.

• **Setting the start and end points of the measurement/computation period simultaneously (For normal measurement mode only)**

11. Press the [Start Pos / End Pos] soft key to set the jog shuttle control to both [Start Pos] and [End Pos].
12. Turn the jog shuttle to set the measurement/computation period. The distance between them is kept constant.

Go to step 13 on page 10-5.

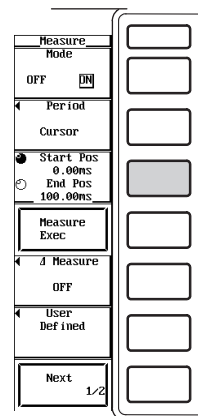
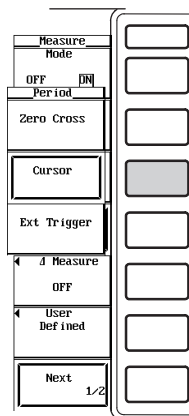
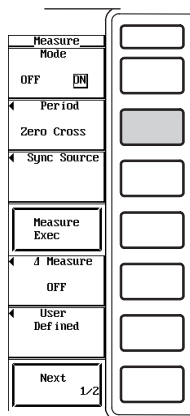
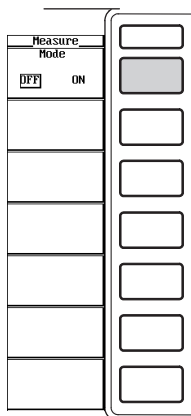

## 10.1 Setting the Measurement/Computation Period, Re-computing

### Setting the period using external trigger

Set the measurement mode to normal measurement. For the procedures, see section 5.1, "Selecting the Measurement Mode."

3. Press the SETUP key to display the Setup menu. Confirm that [Mode] is set to [Normal].
4. Press the MEASURE key to display the Measure setting menu.
5. Press the [Mode] soft key to select [ON].
6. Press the [Period] soft key to display the period setting menu.
7. Press the [Ext Trigger] soft key to select the external trigger setting.

#### • Selecting the trigger condition

8. Press the [Pattern] soft key to select [ ] or [ ].

Go to step 13 on page 10-5.

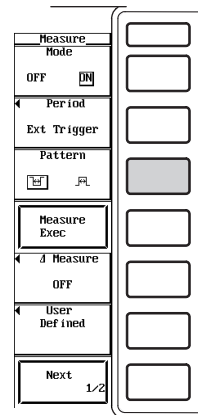
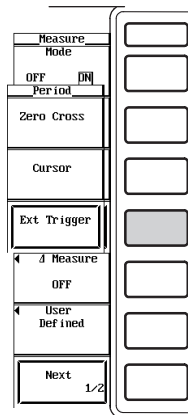
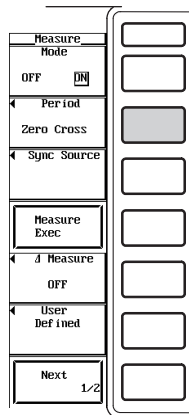
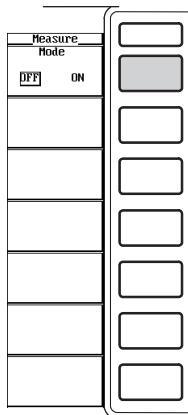

**Re-computing**

13. Press the [Measure Exec] soft key to determine all the numerical data over the measurement/computation period set in the previous pages.

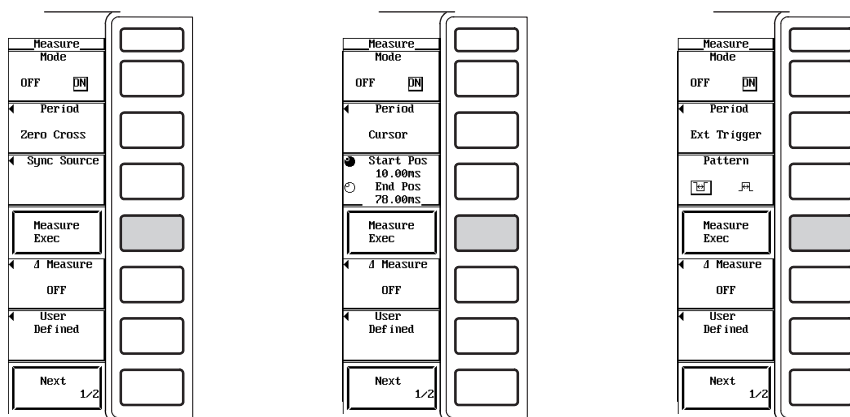
**Explanation**

The numerical data of the measurement functions can be determined using the sampled data in the measurement/computation period that is set in this section. This procedure works for both the normal measurement and harmonic measurement modes.

**Turning ON/OFF the numerical computation mode**

Select whether or not to perform numerical computation.

- OFF
 

Numerical computations are not performed. Because none of the numerical data are determined, the interval between the data acquisition and the waveform display becomes shorter.
- ON
 

All the numerical data are determined. The menu used to set the numerical computation also appears.

**Selecting the method used to set the period**

Select the method used to set the measurement/computation period from the following list of choices. For details pertaining to setting the period for each method, see the following sections.

- Zero Cross
 

The period can be set using zero crossing points. This method is possible only in the normal measurement mode. The period that is automatically determined from the zero level (zero amplitude) points becomes the measurement/computation period.
- Cursor
 

The period can be set using cursors. This method is possible in the normal measurement and harmonic measurement modes. For the normal measurement mode, the measurement/computation period is the period between the cursors. For the harmonic measurement mode, the period is from the start position cursor to 8192 points of sampled data (end position cursor).
- Ext Trigger
 

The period can be set using an external trigger. This method is possible only in the normal measurement mode. The measurement/computation period is the period defined while the signal applied to the external trigger input connector is in the specified condition (⌂ or ⌂).

## 10.1 Setting the Measurement/Computation Period, Re-computing

### Zero crossing setting

The measurement/computation period is set to the period between the first and last points on the screen at which the waveform crosses the zero level (zero crossing) with a positive slope. When there is only one or no positive slope on the screen, the measurement/computation period is set to the entire width of the screen.

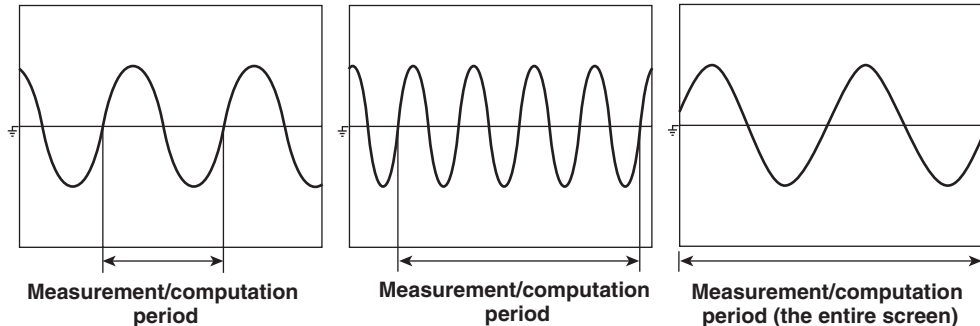

### Selecting the synchronization source

For each element, you can set which input signal to use to synchronize to the zero crossing point. Select the synchronization source from the following choices.

- CH1 to CH8  
The synchronization source is set to the voltage or current of the element which has a module installed. The channel numbers of elements that do not have modules installed are not displayed.
- Ext  
The synchronization source is set to the clock signal applied to the external clock input connector. The specifications of the synchronization source is the same as that of the external clock as described in section 6.3, "Selecting the Time Base."

### Cursor setting

For the normal measurement mode, the measurement/computation period is the period between the two cursors (start and end positions) placed on the screen.

For the harmonic measurement mode, the period is from the start position cursor to 8192 points of sampled data (end position cursor).

- When the measurement mode is normal and the time base is set to internal clock, the start position (dot-dashed line) and end position (dotted line) can be moved in the range from 0 s (the left end of the screen) to the observation time (the right end of the screen). When the time base is set to external clock or when the measurement mode is harmonic, the start and end positions can be moved in the range defined by the number of data points in the record length. For example, if the record length is 100 k-words, then the range is from data point 0 (the left end of the screen) to data point 100 k (the right end of the screen).
- Because the cursor position is displayed in the menu in terms of time when the measurement mode is normal and the time base is set to internal clock, the start and end positions can be set by specifying the times even when the waveform is not displayed.
- When the measurement mode is normal and the time base is set to internal clock, the start and end positions can be set in steps of (observation time ÷ display record length). When the time base is set to external clock or when the measurement mode is harmonic, the start and end positions can be set in steps of one data point.
- To move the start and end positions simultaneously, which keeps the distance between them constant, the jog shuttle must be set to control both [Start Pos] and [End Pos].

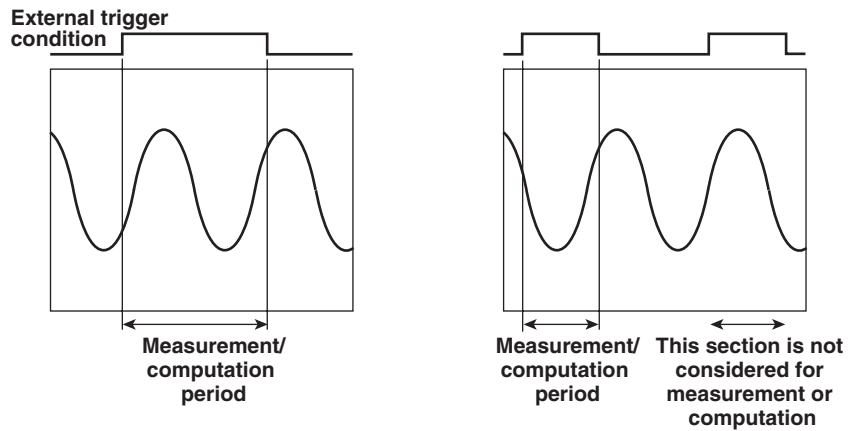

**External trigger setting**

The measurement/computation period is the period defined while the signal applied to the external trigger input connector is in the specified condition (Hi or Lo).



**Selecting the external trigger condition**

Select the external trigger condition from the following choices. For the specifications of the external trigger, see section 7.2, “Selecting the Trigger Source.”

-  The measurement/computation period is set to the period when the external trigger is in the Lo condition.
-  The measurement/computation period is set to the period when the external trigger is in the Hi condition.

**Re-computing**

The measurement/computation period and numerical computation settings can be changed while the data acquisition is stopped and the numerical data can be re-computed. All computations including the measurement function data are redone except for averaging.

**Note**

- To improve the accuracy of the measurement and computations, it is recommended that the measurement/computation period be set as long as possible so that the number of cycles of the input signal becomes large.
- When the measurement/computation period is changed, do a re-computation.

## 10.2 Selecting the Delta Computation

«For a functional description, see section 1.7.»

This section applies when the measurement mode is set to normal measurement.

### Keys

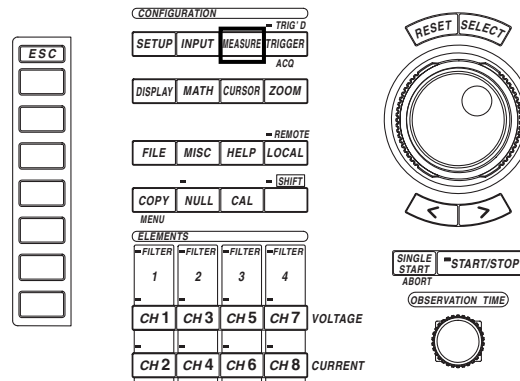

- The  mark indicates the keys that are used for the operation.
- To exit the menu during operation, press the ESC key.

### Procedure

Set the measurement mode to normal measurement. For the procedures, see section 5.1, “Selecting the Measurement Mode.”

1. Press the SETUP key to display the Setup menu. Confirm that [Mode] is set to [Normal].
2. Press the MEASURE key to display the Measure setting menu.
3. Press the [Mode] soft key to select [ON].
4. Press the [ $\Delta$ Measure] soft key to display the delta computation setting menu.
5. Press one of the keys from [OFF] to [Star>Delta] to select the delta computation.

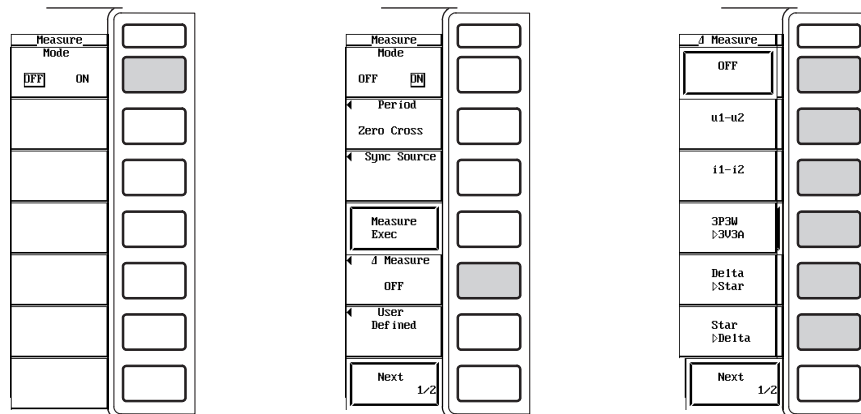



**Explanation**

In the normal measurement mode, the sum or difference of the instantaneous values (sampled data) of the voltage or current between elements 1, 2, and 3 can be used to determine the measurement functions,  $\Delta U$  ( $\Delta U_{rms}$ ,  $\Delta U_{mn}$ ,  $\Delta U_{dc}$ ,  $\Delta U_{ac}$ ),  $\Delta I$  ( $\Delta I_{rms}$ ,  $\Delta I_{mn}$ ,  $\Delta I_{dc}$ ,  $\Delta I_{ac}$ ). This is called delta computation. For the equation, see Appendix 3. The measurement and computation periods are the same as those described in section 1.2, "Measurement Modes and Measurement/Computation Periods." Select the type of delta computation from the following list of choices.

- OFF  
No delta computation is performed.
- u1-u2  
Computes the difference between the voltage of element 1 and the voltage of element 2. For example,  $\Delta U1$  ( $\Delta U_{rms1}$ ,  $\Delta U_{mn1}$ ,  $\Delta U_{dc1}$ ,  $\Delta U_{ac1}$ ) can be determined for the circuit shown in the diagram below.

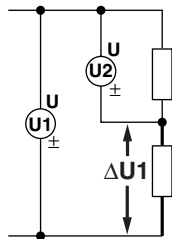

- i1-i2  
Computes the difference between the current of element 1 and the current of element 2. For example,  $\Delta I1$  ( $\Delta I_{rms1}$ ,  $\Delta I_{mn1}$ ,  $\Delta I_{dc1}$ ,  $\Delta I_{ac1}$ ) can be determined for the circuit shown in the diagram below.

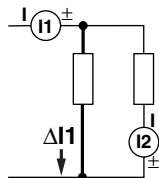

- 3P3W>3V3A  
Computes various data when the wiring method is changed from a three-phase, three-wire system (3P3W) to a three-voltage, three current system (3V3A).  
 $\Delta U1$  ( $\Delta U_{rms1}$ ,  $\Delta U_{mn1}$ ,  $\Delta U_{dc1}$ ,  $\Delta U_{ac1}$ )  
 $\Delta U3$  ( $\Delta U_{rms3}$ ,  $\Delta U_{mn3}$ ,  $\Delta U_{dc3}$ ,  $\Delta U_{ac3}$ )  
 $\Delta I1$  ( $\Delta I_{rms1}$ ,  $\Delta I_{mn1}$ ,  $\Delta I_{dc1}$ ,  $\Delta I_{ac1}$ )  
 $\Delta I3$  ( $\Delta I_{rms3}$ ,  $\Delta I_{mn3}$ ,  $\Delta I_{dc3}$ ,  $\Delta I_{ac3}$ )

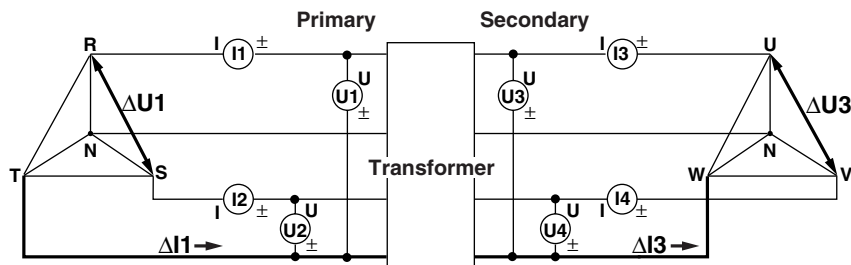

## 10.2 Selecting the Delta Computation

- Delta>Star

Using the data from a three-phase, three-wire system or a three-voltage, three-current system, the various data of a star connection are computed from the data of a delta connection (delta-star transformation).

$\Delta U_1(\Delta U_{rms1}, \Delta U_{mn1}, \Delta U_{dc1}, \Delta U_{ac1})$

$\Delta U_2(\Delta U_{rms2}, \Delta U_{mn2}, \Delta U_{dc2}, \Delta U_{ac2})$

$\Delta U_3(\Delta U_{rms3}, \Delta U_{mn3}, \Delta U_{dc3}, \Delta U_{ac3})$

$\Delta I_4(\Delta I_{rms4}, \Delta I_{mn4}, \Delta I_{dc4}, \Delta I_{ac4})$

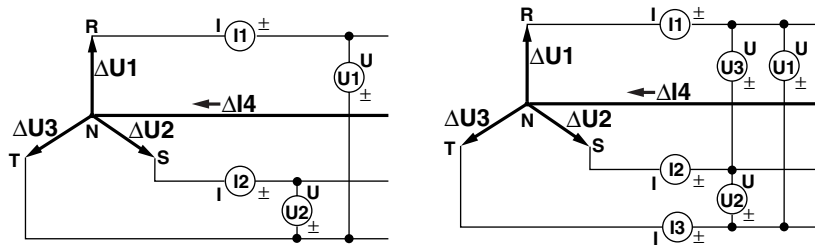

- Star>Delta

Using the data from a three-phase, four-wire system, the various data of a delta connection are computed from the data of a star connection (star-delta transformation).

$\Delta U_1(\Delta U_{rms1}, \Delta U_{mn1}, \Delta U_{dc1}, \Delta U_{ac1})$

$\Delta U_2(\Delta U_{rms2}, \Delta U_{mn2}, \Delta U_{dc2}, \Delta U_{ac2})$

$\Delta U_3(\Delta U_{rms3}, \Delta U_{mn3}, \Delta U_{dc3}, \Delta U_{ac3})$

$\Delta I_4(\Delta I_{rms4}, \Delta I_{mn4}, \Delta I_{dc4}, \Delta I_{ac4})$

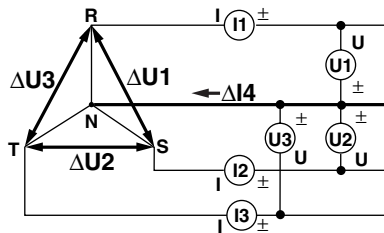

### Note

- If the sampled data used in the computation do not exist (for example, when the module is not installed), the sampled data are considered to be 0's for the computation.
- It is recommended that the measurement range and scaling (PT/CT ratio and coefficients) of the elements that are being computed (delta computation) be set the same as much as possible. Using a different measurement range or scaling causes the measurement resolution of the sampled data to be different. In effect, the computation result will have errors.
- The type of delta computation can be selected when the data acquisition is stopped and the various data can be recomputed. For details, see section 10.1.
- The number that is attached to the measurement function symbol of the delta computation has no relation to the element number. For example, if [i1-i2] is selected from the delta computation menu, the true rms value of [i1-i2] is computed and displayed at [ $\Delta I_{rms1}$ ].
- When the measurement/computation period is changed, do a re-computation. For details, see section 10.1.

# 10.3 Setting the User-Defined Function

«For a functional description, see section 1.7.»

## Keys

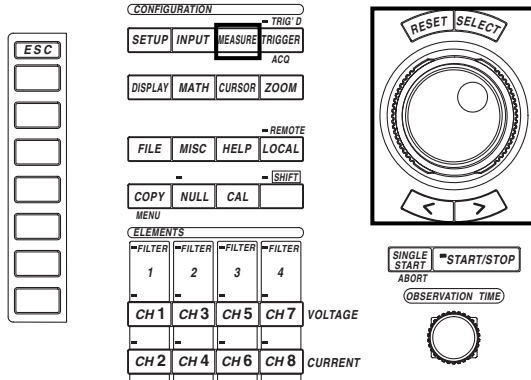

- The  mark indicates the keys that are used for the operation.
- To exit the menu during operation, press the ESC key.

## Procedure

1. Press the MEASURE key to display the Measure setting menu.
2. Press the [Mode] soft key to select [ON].
3. Press the [User Defined] soft key to display the user-defined function setting dialog box.

### Selecting whether or not to perform a user-defined function computation

4. Turn the jog shuttle to select the user-defined function from [Function1] to [Function4].
5. Press the SELECT key to select [ON] or [OFF].

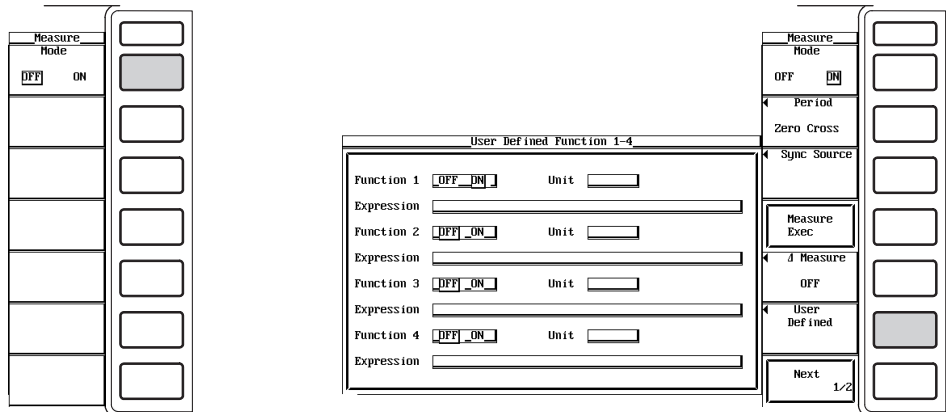

## 10.3 Setting the User-Defined Function

### Setting the unit

6. Turn the jog shuttle to select [Unit].
7. Press the SELECT key. A keyboard appears.
8. Use the keyboard to set the unit.

For keyboard operation, see section 4.1, "Entering Values and Strings."

### Setting the equation

9. Turn the jog shuttle to select [Expression].
10. Press the SELECT key. A keyboard appears.
11. Use the keyboard to set the equation.

For keyboard operation, see section 4.1, "Entering Values and Strings."

User Defined Function 1-4		
Function 1	<input type="checkbox"/> OFF <input type="checkbox"/> ON	Unit <input type="text" value="g"/>
Expression	<input type="text"/>	
Function 2	<input type="checkbox"/> OFF <input type="checkbox"/> ON	Unit <input type="text"/>
Expression	<input type="text"/>	
Function 3	<input type="checkbox"/> OFF <input type="checkbox"/> ON	Unit <input type="text"/>
Expression	<input type="text"/>	
Function 4	<input type="checkbox"/> OFF <input type="checkbox"/> ON	Unit <input type="text"/>
Expression	<input type="text"/>	

User Defined Function 1-4		
Function 1	<input type="checkbox"/> OFF <input type="checkbox"/> ON	Unit <input type="text" value="g"/>
Expression	<input type="text" value="(DRHS(CE1)/1DRHS(CE1))"/>	
Function 2	<input type="checkbox"/> OFF <input type="checkbox"/> ON	Unit <input type="text"/>
Expression	<input type="text"/>	
Function 3	<input type="checkbox"/> OFF <input type="checkbox"/> ON	Unit <input type="text"/>
Expression	<input type="text"/>	
Function 4	<input type="checkbox"/> OFF <input type="checkbox"/> ON	Unit <input type="text"/>
Expression	<input type="text"/>	

### Explanation

An equation can be created by combining the measurement function symbols. Using the numerical values of the measurement functions, the numerical data of the new equation can be determined.

### Turning ON/OFF the user-defined function

Select whether or not to perform the user-defined function computation.

- OFF  
Does not compute the equation.
- ON  
Computes the equation.

### Setting the unit

- Number of characters  
The unit can be set using eight characters or less. However, when all numerical data are being displayed, only the first six characters are displayed.
- Types of characters  
You can use the characters that are displayed on the keyboard or a space

### Setting the equation

The combination of the measurement function and element number (Urms1, for example) can be used as an operand to create up to four equations (F1 to F4) for each measurement mode (normal and harmonic). There can be up to 16 operands in one equation.

- **Measurement functions for computation**

**Measurement functions : The measurement functions are shown in the form of operands** (symbols used when defining equations) as follows.

- **During normal measurement mode**

Urms : URMS( ), Umn : UMN( ), Udc : UDC( ), Uac : UAC( ), Irms : IRMS( ),  
 Imn : IMN( ), Idc : IDC( ), Iac : IAC( ), P : P( ), S : S( ), Q : Q( ),  $\lambda$  : LAMBDA( ),  
 $\phi$  : PHI( ), fU : FU( ), fI : FI( ), U+pk : UPPK( ), U-pk : UMPK( ), I+pk : IPPK( ),  
 I-pk : IMPK( ), CfU : CFU( ), CfI : CFI( ), FfU : FFU( ), FfI : FFI( ), Z : Z( ),  
 Rs : RS( ), Xs : XS( ), Rp : RP( ), Xp : XP( ), Pc : PC( ),  $\eta$  : ETA( ),  
 $1/\eta$  : DIVETA( ),  $\Delta$ Urms : DELTAURM( ),  $\Delta$ Umn : DELTAUMN( ),  
 $\Delta$ Udc : DELTAUDC( ),  $\Delta$ Uac : DELTAUAC( ),  $\Delta$ Irms : DELTAIRM( ),  
 $\Delta$ Imn : DELTAIMN( ),  $\Delta$ Idc : DELTAIDC( ),  $\Delta$ Iac : DELTAIAC( ), Torque:  
 TORQUE( ), Speed: SPEED( ), Slip: SLIP( ), Sync: SYNC( ),  $\eta$ mA: MAETA( ),  
 $\eta$ mB: MBETA( )

- A symbol representing the element to which the measured signal is to be applied is entered in parentheses (excluding delta functions DELTAURM( ) to DELTAIAC( )). Elements 1, 2, 3, 4,  $\Sigma$ A, and  $\Sigma$ B are represented by the symbols E1, E2, E3, E4, E5, and E6, respectively. One symbol from E1 to E6 can be used, except for the following computation symbols.
  - One symbol from E1 to E4 can be entered in the parentheses for FU( ) to FFI( ) functions.
  - No symbols need to be entered in the parentheses for ETA( ), DIVETA( ), TORQUE( ), SPEED( ), SLIP( ), SYNC( ), MAETA( ), and MBETA( ).
- The element symbol inside the parentheses of delta computation (DELTAURM( ) to DELTAIAC( )) does not represent the element to which the measured signal is to be applied, but rather the location at which to store or display the results of the delta computation.  $\Delta$ 1,  $\Delta$ 2,  $\Delta$ 3, and  $\Delta$ 4 are represented by symbols E1, E2, E3, and E4, respectively. You can specify one symbol from E1 to E4 within the definition of the delta computation. For details regarding delta computations, see section 10.2.
- The measurement functions  $\eta$ (efficiency 1) and  $1/\eta$ (efficiency 2) are displayed as percentages as indicated by the equations given in Appendix 2, "Symbols and Determination of Measurement Functions." However, measurement functions ETA and DIVETA described in this section are displayed as ratios.

Example  $\eta$  : 80%, ETA = 0.8

### 10.3 Setting the User-Defined Function

- **During harmonic measurement mode**

U : U( , ), I : I( , ), P : P( , ), S : S( , ), Q : Q( , ), λ : LAMBDA( , ), φ : PHI( , ),  
 φU : UPHI( , ), φI : IPHI( , ), Z : Z( , ), Rs : RS( , ), Xs : XS( , ), Rp : RP( , ),  
 Xp : XP( , ), UhdF : UHDF( , ), Ihdf : IHDF( , ), Phdf : PHDF( , ), Uthd : UTHD( , ),  
 lthd : ITHD( , ), Pthd : PTHD( , ), Uthf : UTHF( , ), lthf : ITHF( , ), Utif : UTIF( , ),  
 ltif : ITIF( , ), hvf : HVF( , ), hcf : HCF( , ), fU : FU( , ), fl : FI( , ), φU1-U2 : PHIU1U2( , ),  
 φU1-U3 : PHIU1U3( , ), φU1-I1 : PHIU1I1( , ), φU1-I2 : PHIU1I2( , ),  
 φU1-I3 : PHIU1I3( , ), Torque: TORQUE( , ), Speed: SPEED( , ), Slip: SLIP( , ), Sync:  
 SYNC( , ), ηmA: MAETA( , ), ηmB: MBETA( )

- A symbol representing the element to which the measured signal is to be applied is entered on the left side of the parentheses containing a comma ( , ). OR followed by the harmonic order is entered on the right side. (E1,OR2) is an example. Elements 1, 2, 3, 4, ΣA, and ΣB are represented by the symbols E1, E2, E3, E4, E5, and E6, respectively.
  - One symbol from E1 to E6 can be entered in the parentheses for U( , ) to LAMBDA( , ).
  - One symbol from E1 to E4 can be entered in the parentheses for PHI( , ) to FI( ).
  - E5 or E6 can be entered in the parentheses for PHIU1U2( ) to PHIU1I3( ).
  - For operands that do not have a comma inside the parentheses, no harmonic order needs to be specified. Set an harmonic order for TORQUE( ) only.
- If the harmonic section is set to “ORT,” it represents Total; if it is set to “0 (zero),” it represents DC.

- **Operators**

The following operators can be used to create the equation.

Operator	Example of use	Description
+, -, *, /	URMS(E1)+URMS(E2) U(E1,OR1)-U(E2,OR1)	Basic arithmetic of the measurement functions
ABS	ABS(UMN(E1)-UMN(E2)) ABS(P(E1,ORT)+P(E2,ORT))	Absolute value of the measurement function
SQR	SQR(IDC(E1)) SQR(I(E1,OR0))	Square of the measurement function
SQRT	SQRT(ABS(IDC(E1))) SQRT(ABS(I(E1,OR3)))	Square root of the measurement function
LOG	LOG(UDC(E1)) LOG(U(E1,OR25))	Natural log of the measurement function
LOG10	LOG10(UDC(E1)) LOG10(U(E1,OR25))	Common log of the measurement function
EXP	EXP(UAC(E1)) EXP(U(E1,OR12))	Exponent of the measurement function
NEG	NEG(URMS(E1)) NEG(U(E1,OR12))	Negation the measurement function

- **Number and type of characters that can be used in the equation**

- Number of characters  
50 characters or less
- Types of characters  
Characters that are displayed on the keyboard or a space

**Note**

- An equation (F1 to F4) cannot be placed inside another equation (F1 to F4).
- When the measurement/computation range or the equation is changed, do a re-computation. For information pertaining to changing the measurement/computation range and re-computation, see section 10.1.
- If an operand in the equation is undetermined, the computation result displays [-----] (no data). For example, if a measurement function of a delta computation is in the equation, but delta computation is turned [OFF] or a measurement function of an element that does not have a module installed is in the equation, an error message is displayed.
- When averaging (see section 10.5) is turned [ON], the user-defined function cannot be turned ON.

# 10.4 Setting the Equations for Apparent Power and Corrected Power

«For a functional description, see section 1.7.»

## Keys

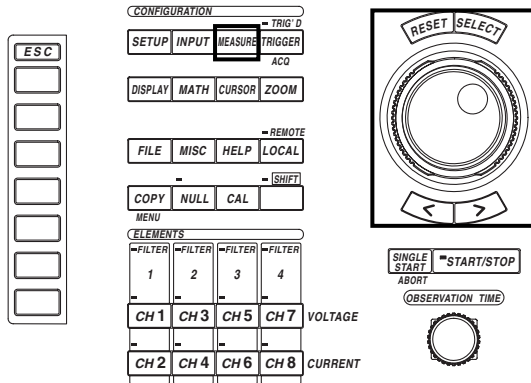

- The  mark indicates the keys that are used for the operation.
- To exit the menu during operation, press the ESC key.

## Procedure

1. Press the MEASURE key to display the Measure setting menu.
2. Press the [Mode] soft key to select [ON].
3. Press the [Next 1/2] soft key to display the [Next 2/2] menu.

### Selecting the equation for apparent power

4. Press the [S Formula] soft key to display the equation selection menu for apparent power.
5. Press one of the soft keys from [Urms\*Irms] to [Udc\*Idc] to select the equation.

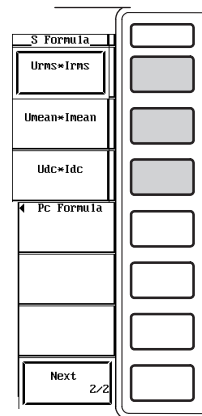
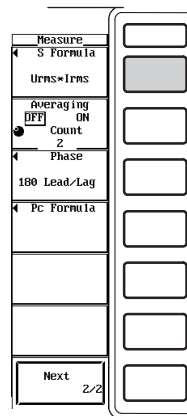
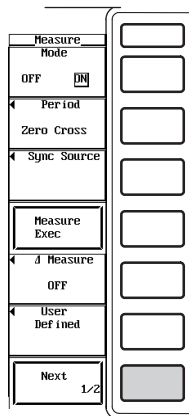
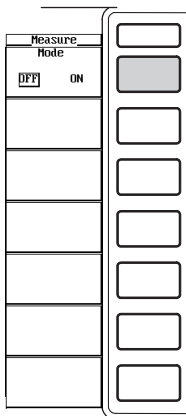

## 10.4 Setting the Equations for Apparent Power and Corrected Power

### Setting the equation for corrected power

- Press the [Pc Formula] soft key to display the equation setting dialog box for corrected power.

- Selecting the applicable standard**

- Turn the jog shuttle to select the standard for [Pc Formula].
- Press the SELECT key to select either [IEC76-1(1976), IEEE C57.12.90-1993] or [IEC76-1(1993)].

- Setting the coefficient**

**(When the applicable standard of the equation is [IEC76-1(1976), IEEE C57.12.90-1993])**

- Turn the jog shuttle to select [P1=].
- Press the SELECT key. A box used to set coefficient P1 appears.
- Turn the jog shuttle to set coefficient P1.  
For the procedures related to entering values using the jog shuttle, see section 4.1, "Entering Values and Strings."
- Press the SELECT key or the ESC key to close the setting box.
- Turn the jog shuttle to select [P2=].
- Press the SELECT key. A box used to set coefficient P2 appears.  
For the procedures related to entering values using the jog shuttle, see section 4.1, "Entering Values and Strings."
- Press the SELECT key or the ESC key to close the setting box.

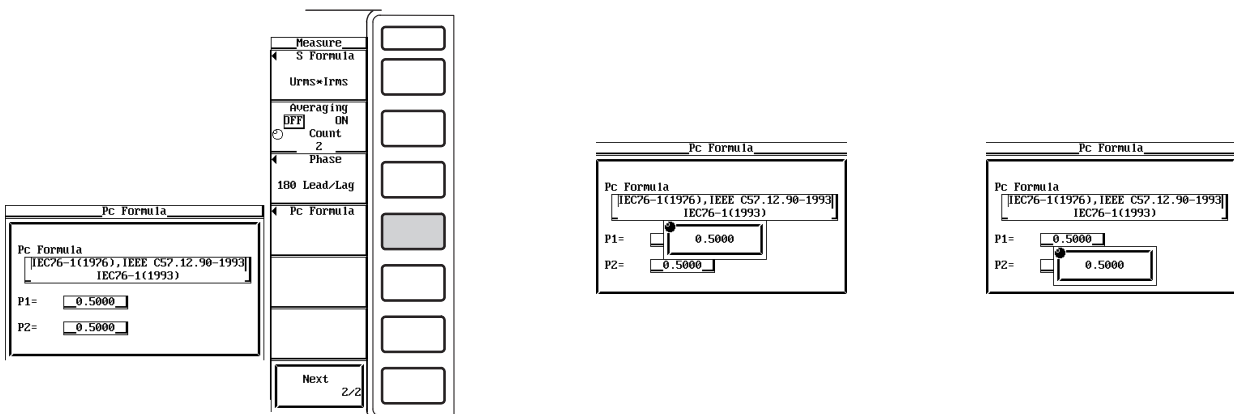



**Explanation****Selecting the equation for apparent power**

The apparent power, in the normal measurement mode, can be determined by the product of the voltage and current. There are three types of voltages and currents when measuring in the normal measurement mode. Select which voltage and current to use to determine the apparent power from the following list of choices.

- $U_{rms} \cdot I_{rms}$   
Determines the apparent power from the true rms values of voltage and current.
- $U_{mean} \cdot I_{mean}$   
Determines the apparent power from the rectified mean value calibrated to the rms value of the voltage and current.
- $U_{dc} \cdot I_{dc}$   
Determines the apparent power from the simple average of the voltage and current.

**Setting the equation for corrected power**

Depending on the applicable standard, when the load that is connected to the potential transformer is extremely small, the active power of the potential transformer that is measured needs to be compensated. In such case, set the compensating equation and the coefficient. Corrected power ( $P_c$ ) is a measurement function in the normal measurement mode.

- **Selecting the applicable standard**

Select the standard from the following choices. The equation varies depending on the selected standard.

- IEC76-1(1976), IEEE C57.12.90-1993

Equation

$$P_c = \frac{P}{P_1 + P_2 \left( \frac{U_{rms}}{U_{mn}} \right)^2}$$

$P_c$  : Corrected Power

$P$  : Active power

$U_{rms}$  : True rms voltage

$U_{mn}$  : Voltage (rectified mean value calibrated to the rms value)

$P_1, P_2$  : Coefficient as defined in the applicable standard (see "Setting the coefficient.")

- IEC76-1(1993)

Equation

$$P_c = P \left( 1 + \frac{U_{mn} - U_{rms}}{U_{mn}} \right)$$

$P_c$  : Corrected Power

$P$  : Active power

$U_{rms}$  : True rms voltage

$U_{mn}$  : Voltage (rectified mean value calibrated to the rms value)

- **Setting the coefficient**

Set coefficients  $P_1$  and  $P_2$ .

Set the coefficients in the range from 0.0001 to 9.9999.

**Note**

The equations of apparent power and corrected power are applied to measurement functions in the normal measurement mode.

# 10.5 Averaging

«For a functional description, see section 1.7.»

## Keys

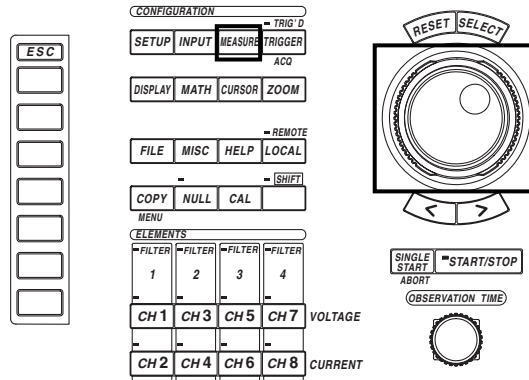

- The  mark indicates the keys that are used for the operation.
- To exit the menu during operation, press the ESC key.

## Procedure

1. Press the MEASURE key to display the Measure setting menu.
2. Press the [Mode] soft key to select [ON].
3. Press the [Next 1/2] soft key to display the [Next 2/2] menu.

### Turn ON/OFF the averaging function

4. Press the [Averaging] soft key to select [ON] or [OFF].

### Setting the attenuation constant

5. Turn the jog shuttle to set the attenuation constant.

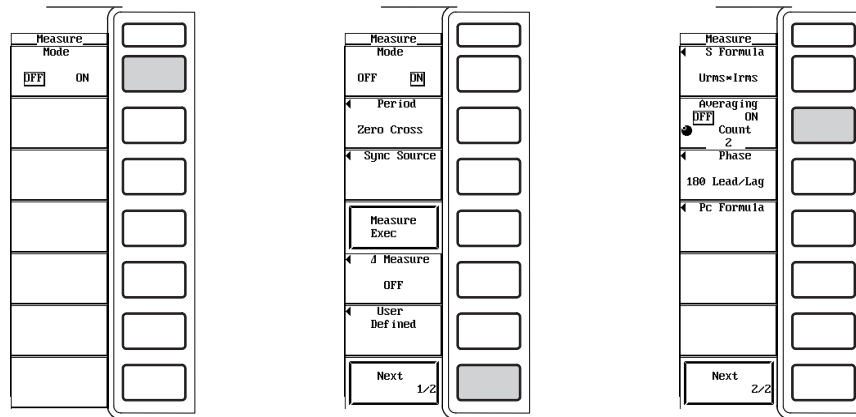

**Explanation**

The numerical data can be exponentially averaged using the specified attenuation constant.

**Turning ON/OFF the averaging function**

Select whether or not to perform the specified averaging function.

- OFF : Does not perform the averaging function.
- ON : Performs the averaging function.

The averaging is performed according to the following equation.

$$D_n = D_{n-1} + \frac{(M_n - D_{n-1})}{K}$$

$D_n$  : Displayed value at the  $n$ th time that has been exponentially averaged. (The displayed value  $D_1$  on the first time is  $M_1$ .)

$D_{n-1}$  : Display value at the  $n-1$ st time that has been exponentially averaged.

$M_n$  : Measured data at the  $n$ th time.

$K$  : Attenuation constant (see "Setting the attenuation constant.")

- **Measurement functions that are averaged**

The measurement functions that are directly averaged are shown below. Other functions that use these functions in their computation are also affected by the averaging. For details regarding the determination of each measurement function, see Appendix 2.

- For the normal measurement mode  
Urms, Irms, Umn, Imn, Udc, Idc, P
- For the harmonic measurement mode  
U(k), I(k), P(k), Q(k)  
\* k : harmonic order

**Setting the attenuation constant**

Select the attenuation constant from 2, 4, 8, 16, 32, and 64.

**Note**

- The following measurement functions are not affected by averaging.
  - For the harmonic measurement mode  
fU, fI, U+pk, U-pk, I+pk, I-pk
  - For the harmonic measurement mode  
 $\phi U(k)$ ,  $\phi I(k)$ ,  $\phi U1-U2$ ,  $\phi U1-U3$ ,  $\phi U1-I1$ ,  $\phi U1-I2$ ,  $\phi U1-I3$   
\* k : harmonic order
- If the data acquisition is stopped while averaging is in progress and the acquisition is restarted, the averaging process continues.
- Averaging cannot be turned [ON] when the user-defined function is turned [ON] or when the [Mode] of the waveform computation (see section 11.2) is [ON] and either [Math1] or [Math2] is [ON].

# 10.6 Selecting the Display Format of the Phase Difference

«For a functional description, see section 1.7.»

## Keys

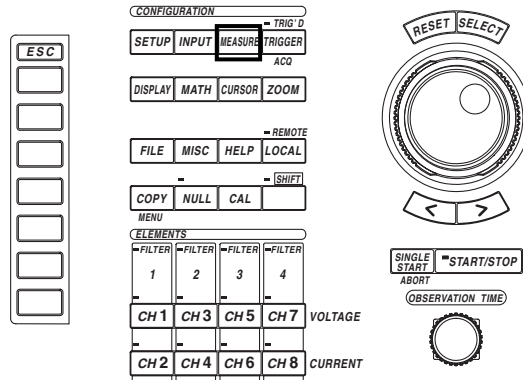

- The  mark indicates the keys that are used for the operation.
- To exit the menu during operation, press the ESC key.

## Procedure

1. Press the MEASURE key to display the Measure setting menu.
2. Press the [Mode] soft key to select [ON].
3. Press the [Next 1/2] soft key to display the [Next 2/2] menu.
4. Press the [Phase] soft key to display the menu used to select the display format of the phase difference.
5. Press either the [180 Lead/Lag] or [360 degrees] soft key to select the display format.

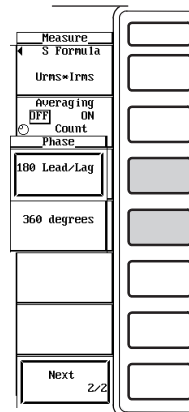
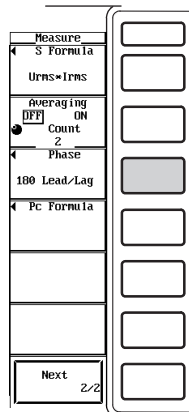
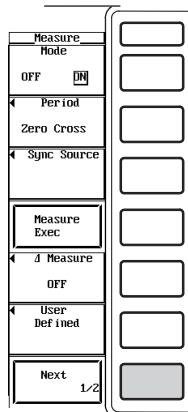
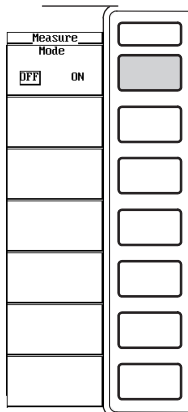

**Explanation**

Select the display format of the phase difference  $\phi$  of the voltage and current from the following choices. This is valid during the normal measurement mode.

- 180 Lead/Lag  
With the positive vertical axis set to zero degrees, this format displays  $\phi$  using  $180^\circ$  notation with a lead indicated by the counter-clock wise direction and a lag by the clockwise direction.
- 360 degrees  
With the positive vertical axis set to zero degrees, this format displays  $\phi$  using  $360^\circ$  in the clockwise direction.

**Note**

- The display format in the harmonic measurement mode is fixed regardless of the selection as follows.  
Measurement function  $\phi( )$  is displayed using  $360^\circ$  representation in the clockwise direction. Measurement functions  $\phi U( )$  and  $\phi I( )$  are displayed using  $180^\circ$  representation with respect to the fundamental waves  $U(1)$  and  $I(1)$ . The counter-clockwise direction is negative and clockwise direction is positive.
- When the voltage or current input is less than or equal to 0.25% of the measurement range, an error [Error] is displayed.
- When both the voltage and current are sinusoids and the ratio of the voltage and current inputs do not differ greatly with respect to the measurement range, the phase difference  $\phi$  of lead (D) and lag (G) are detected and displayed correctly.
- When the computation result of power factor  $\lambda$  exceeds "1,"  $\phi$  is displayed as follows:
  - When the power factor  $\lambda$  is greater than 1.001 and less than equal to 2.000,  $\phi$  displays zero.
  - When the power factor  $\lambda$  is greater than 2.001,  $\phi$  displays an error [Error].

## 10.7 Setting the Harmonic Orders under Analysis

This section applies when the measurement mode is set to harmonic measurement.

### Keys

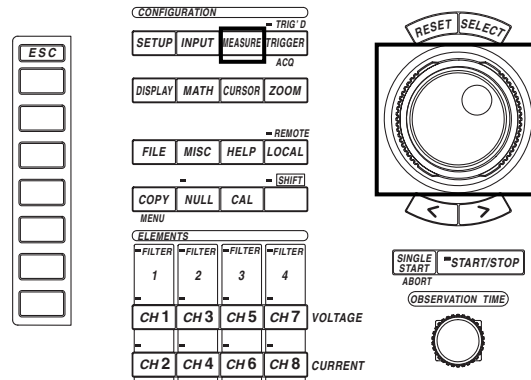

- The  mark indicates the keys that are used for the operation.
- To exit the menu during operation, press the ESC key.

### Procedure

Set the measurement mode to harmonic measurement. For the procedures, see section 5.1, “Selecting the Measurement Mode.”

1. Press the SETUP key to display the Setup menu. Confirm that [Mode] is set to [Harmonics].
2. Press the MEASURE key to display the Measure setting menu.
3. Press the [Mode] soft key to select [ON].
4. Press the [Next 1/2] soft key to display the [Next 2/2] menu.

#### Selecting the minimum harmonic order under analysis

5. Press the [Min Order] soft key to select [0] or [1].

#### Selecting the maximum harmonic order under analysis

6. Turn the jog shuttle to set the maximum harmonic order to be analyzed.

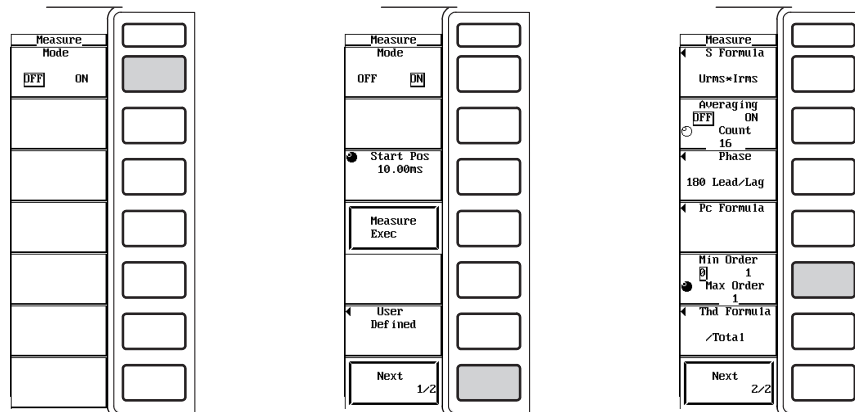

**Explanation**

Select the range of harmonic orders that will be used to determine the numerical data of the measurement functions of the harmonic waveform.

**Selecting the minimum harmonic order under analysis**

Select from the following choices.

- 0  
Includes the 0th order (DC) component when determining the various numerical data of the harmonic waveform.
- 1  
Does not include the 0th order (DC) component when determining the various numerical data of the harmonic waveform. 1st order (fundamental signal) is the first component used.

**Selecting the maximum harmonic order under analysis**

Select the harmonic order in the range from 1 to 500th order.

**Note**

- When the minimum harmonic order is set to [1], the numerical data of Total of the harmonic measurement data will not include the DC component.
- You can set the maximum harmonic order to be up to 500th order, but the maximum harmonic order that is actually used to determine the numerical data is the order corresponding to the upper limit of the harmonic order under analysis. This upper limit is automatically determined (maximum is 500) from the frequency of the PLL source. The numerical data corresponding harmonic orders exceeding the upper limit are shown as [-----] (no data).

# 10.8 Selecting the Equation for the Distortion Factor

«For a functional description, see section 1.7.»

This section applies when the measurement mode is set to harmonic measurement.

## Keys

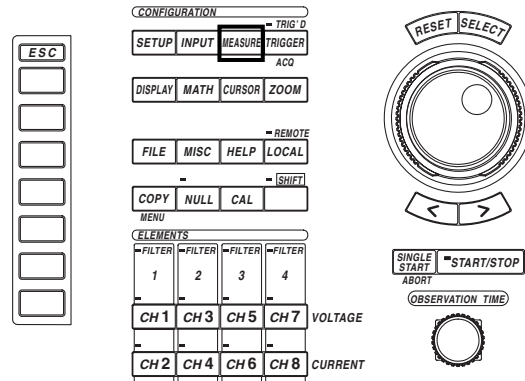

- The  mark indicates the keys that are used for the operation.
- To exit the menu during operation, press the ESC key.

## Procedure

Set the measurement mode to harmonic measurement. For the procedures, see section 5.1, “Selecting the Measurement Mode.”

1. Press the SETUP key to display the Setup menu. Confirm that [Mode] is set to [Harmonics].
2. Press the MEASURE key to display the Measure setting menu.
3. Press the [Mode] soft key to select [ON].
4. Press the [Next 1/2] soft key to display the [Next 2/2] menu.
5. Press the [Thd Formula] soft key to display the menu used to select the equation for the distortion factor.
6. Press either the [/Total] or [/Fundamental] soft key to select the equation.

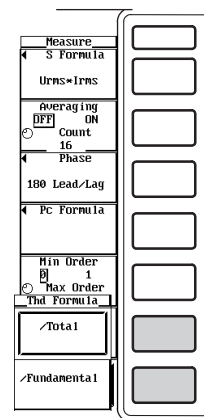
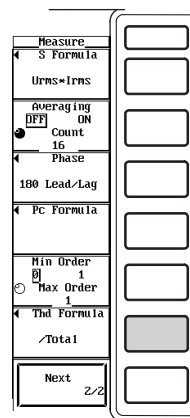
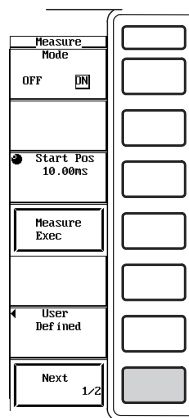
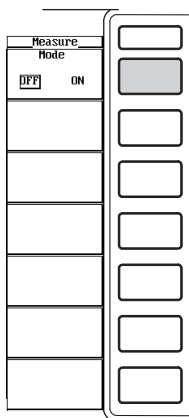



**Explanation**

When determining the measurement functions  $U_{hdf}$ ,  $I_{hdf}$ ,  $P_{hdf}$ ,  $U_{thd}$ ,  $I_{thd}$ , and  $P_{thd}$  of the harmonic measurement mode, select the denominator of the equation from the following choices. See Appendix 2 for the equation.

- /Total  
All harmonic measurement data from the minimum to the maximum harmonic order (up to the upper limit harmonic order) under analysis become the denominator.
- /Fundamental  
The data of the fundamental signal component (1st order) become the denominator.

**Note**

---

The minimum and maximum harmonic orders under analysis are the components selected in section 10.7.

---

# 11.1 Setting the Computation Region, Re-computing

## Keys

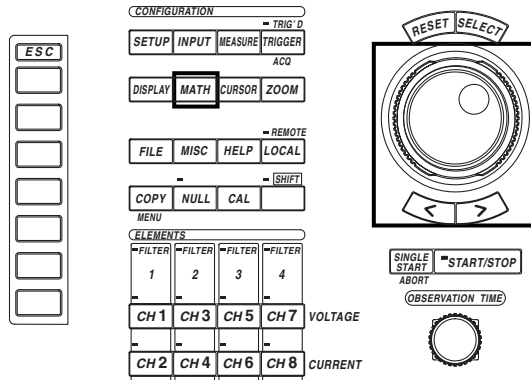

- The   mark indicates the keys that are used for the operation.
- To exit the menu during operation, press the ESC key.

## Procedure

Select a display format to display the waveforms. For the procedures, see section 9.1, “Selecting the Channel to Display.”

1. Press the DISPLAY key to display the Display setting menu.
2. Press the [Format] soft key to display the display format selection box. Check that [Format] is set to [Wave], [Numeric+Wave], [Wave+Bar], or [Wave+X-Y].
  - \* X-Y waveform display is applicable to products (PZ4000) with firmware version 2.01 or later.

The following procedures are given with the premise that the display format is set to [Wave].

### Setting the computation region

3. Press the MATH key to display the Math setting menu.
4. Press the [Mode] soft key to select [ON].

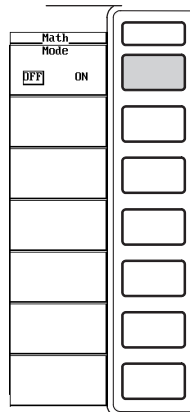

## 11.1 Setting the Computation Region, Re-computing

### • Setting the start point

5. Press the [Start Point / End Point] soft key to set the jog shuttle control to [Start Point].
6. Turn the jog shuttle to set the start point on the waveform.

### • Setting the end point

7. Press the [Start Point / End Point] soft key to set the jog shuttle control to [End Point].
8. Turn the jog shuttle to set the end point on the waveform.

### • Setting the start and end points simultaneously

9. Press the [Start Point / End Point] soft key to set the jog shuttle control to both [Start Point] and [End Point].
10. Turn the jog shuttle to set the computation region. The distance between the start and end points is kept constant.

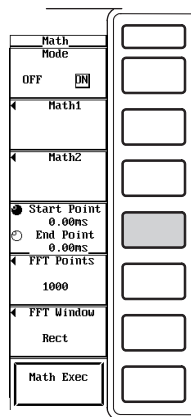

### Re-computing

11. Press the [Math Exec] soft key. The waveform computation is performed over the specified region.

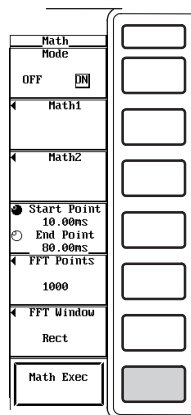

**Explanation**

Select the computation region for performing waveform computations that are described later (see section 11.2), or select the start point for the FFT (see section 11.3).

**Turning ON/OFF the waveform computation mode**

Select whether or not to perform waveform computations.

- OFF  
Does not perform waveform computations.
- ON  
Performs waveform computations. The menu used to set the waveform computation is also displayed.

**Setting the computation region**

The waveform computation region is set to the region between the two cursors (start and end points) that are placed on the screen.

- When the measurement mode is normal and the time base is set to internal clock, the start position (dot-dashed line) and end position (dotted line) can be moved in the range from 0 s (the left end of the screen) to the observation time (the right end of the screen). When the time base is set to external clock or when the measurement mode is harmonic, the start and end positions can be moved in the range defined by the number of data points in the record length. For example, if the record length is 100 k-words, then the range is from data point 0 (the left end of the screen) to data point 100 k (the right end of the screen).
- Because the cursor position is displayed in the menu in terms of time when the measurement mode is normal and the time base is set to internal clock, the start and end points can be set by specifying the times even when the waveform is not displayed. By using a display format that displays the waveform, the start and end points can be set while viewing the waveform.
- When the measurement mode is normal and the time base is set to internal clock, the start and end points can be set in steps of (observation time ÷ display record length). When the time base is set to external clock or when the measurement mode is harmonic, the start and end points can be set in steps of one data point.
- To move the start and end points simultaneously, which keeps the distance between them constant, the jog shuttle must be set to control both [Start Point] and [End Point].

**Re-computing**

- The computation region can be changed and waveform computations can be re-performed while the data acquisition is stopped.
- The upper and lower limits can be set on the computation waveform. There are two methods available to set the upper and lower limits. One method is auto scaling in which the upper and lower limits are automatically determined from the computed waveform. The other method is manual scaling in which the upper and lower limits are set to predetermined values. For the procedures, see section 11.2, "Setting the Equation, Converting the Scale of the Computed Waveform." You can also select whether or not to display the upper and lower limits. For the procedures related to turning ON/OFF the display, see section 9.6, "Turning ON/OFF the Upper and Lower Limit Displays."

**Note**

The number of points from the start point to the end point is counted from the start point up to a maximum of 100 kW.

# 11.2 Setting the Equation, Converting the Scale of the Computed Waveform

«For a functional description, see section 1.8.»

## Keys

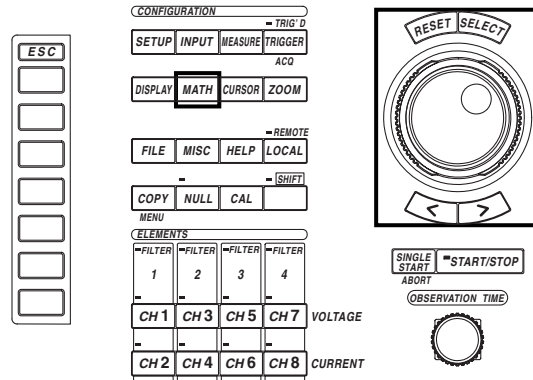

- The  mark indicates the keys that are used for the operation.
- To exit the menu during operation, press the ESC key.

## Procedure

1. Press the MATH key to display the Math setting menu.
2. Press the [Mode] soft key to select [ON].
3. Press either the [Math1] or [Math2] soft key to display the equation setting dialog box.

### Selecting whether or not to perform the computation of the equation (ON/OFF)

4. Turn the jog shuttle to select [Function].
5. Press the SELECT key to select [ON] or [OFF].

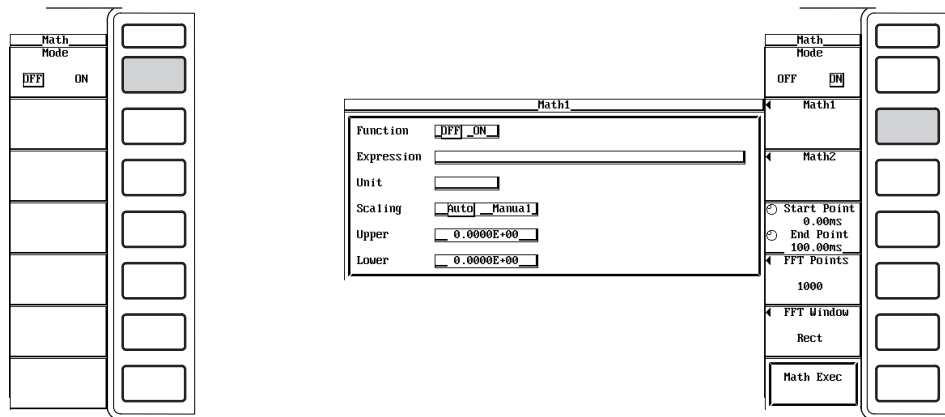

**Setting the equation**

6. Turn the jog shuttle to select [Expression].
7. Press the SELECT key. A keyboard appears.
8. Use the keyboard to enter the equation.

For keyboard operation, see section 4.1, "Entering Values and Strings."

**Setting the unit**

9. Turn the jog shuttle to select the [Unit].
10. Press the SELECT key. A keyboard appears.
11. Use the keyboard to enter the unit.

For keyboard operation, see section 4.1, "Entering Values and Strings."

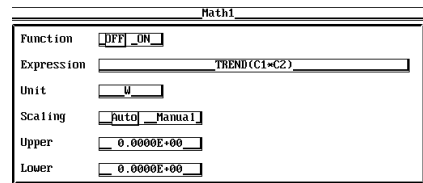
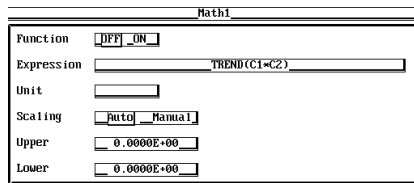

**Converting the scale of the computed waveform**

• **Selecting auto scaling or manual scaling**

12. Turn the jog shuttle to select [Scaling].
13. Press the SELECT key to select either [Auto] or [Manual].

• **Setting the upper and lower limits for manual scaling**

14. Turn the jog shuttle to select [Upper].
15. Press the SELECT key to display the upper limit setting box.
16. Turn the jog shuttle to set the upper limit.  
For the procedures related to entering values using the jog shuttle, see section 4.1, "Entering Values and Strings."
17. Press the SELECT key or the ESC key to close the setting box.
18. Turn the jog shuttle to select [Lower].
19. Press the SELECT key to display the lower limit setting box.
20. Turn the jog shuttle to set the lower limit.  
For the procedures related to entering values using the jog shuttle, see section 4.1, "Entering Values and Strings."

21. Press the SELECT key or the ESC key to close the setting box.

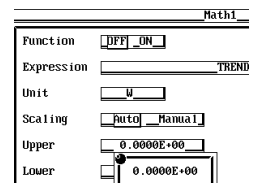
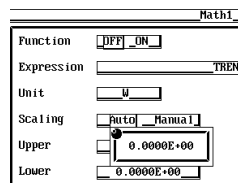
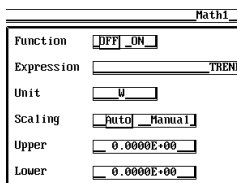

## 11.2 Setting the Equation, Converting the Scale of the Computed Waveform

### Explanation

An equation can be created by combining the symbols of each channel. Then, the waveform of the equation can be displayed.

#### Turning ON/OFF the computation of the equation

Select whether or not to compute the specified equation.

- OFF  
Does not compute the equation.
- ON  
Computes the equation.

#### Setting the equation

Two equations can be created. Each equation can have up to 16 operands. However, for TREND (including TRENDM, TREND, and TRENDF) and FFT functions, only one operand can be used from the following: C1 to C8, C1\*C2, C3\*C4, C5\*C6, or C7\*C8.

##### • Operands

C1 to C8, which correspond to CH1 to CH8, can be used as operands when constructing the equation. However, for TREND and FFT functions, only one operand can be used from the following : C1 to C8, C1\*C2, C3\*C4, C5\*C6, or C7\*C8.

##### • Operator

The following operators can be used to create the equation. TINTG (integral), TINTG (integral), TREND (including TRENDM, TREND, and TRENDF), AVG, SSP, SLIP, and PM are available as special functions. For details regarding these special functions see section 1.8, "Waveform Analysis."

Operator	Example	Description
+, -, *, /	C1+C2	Basic arithmetic of the specified waveform
ABS	ABS(C1)	Absolute value of the specified waveform
SQR	SQR(C1)	Square of the specified waveform
SQRT	SQRT(C1)	Square root of the specified waveform
LOG	LOG(C1)	Natural logarithm of the specified waveform
LOG10	LOG10(C1)	Common logarithm of the specified waveform
EXP	EXP(C1)	Exponentiation of the specified waveform
NEG	NEG(C1)	Add a minus sign to the specified waveform
DIF	DIF(C1)	The differentiation of the specified waveform
TINTG	TINTG(C1)	Integration of the specified waveform
TREND	TREND(C1*C2)	The trend of the specified waveform TRENDM, TREND, and TRENDF can also be specified in a similar fashion. For details, see section 1.8.
AVG2	AVG2(C1*C2)	The average waveform of the specified waveform, attenuation constant of 2
AVG4	AVG4(C1*C2)	The average waveform of the specified waveform, attenuation constant of 4
AVG8	AVG8(C1*C2)	The average waveform of the specified waveform, attenuation constant of 8
AVG16	AVG16(C1*C2)	The average waveform of the specified waveform, attenuation constant of 16
AVG32	AVG32(C1*C2)	The average waveform of the specified waveform, attenuation constant of 32
AVG64	AVG64(C1*C2)	The average waveform of the specified waveform, attenuation constant of 64
SSP	SSP	Synchronous speed waveform
SLIP	SLIP	Slip waveform
PM	PM	Waveform of the motor output
FFT	FFT(C1)	The FFT of the specified waveform (see section 11.3)

\* Functions TRENDM, TREND, TRENDF, SSP, SLIP, and PM are applicable to products (PZ4000) with firmware version 2.01 or later.

- **Number and type of characters that can be used in the equation**

- Number of characters  
50 characters or less
- Types of characters  
Characters that are displayed on the keyboard or a space

**Setting the unit**

- Number of characters  
8 characters or less
- Types of characters  
Characters that are displayed on the keyboard or a space

**Converting the scale of the computed waveform**

The upper and lower limits of the display frame used to display the computed waveform can be set. Select the method to set these limits from the following choices.

- Auto  
Sets the method to auto scaling. The upper and lower limits of the display are automatically determined from the maximum and minimum values of the computed result.
- Manual  
Sets the method to manual scaling. The upper and lower limits can be set arbitrarily as necessary.

**Setting the upper and lower limits for manual scaling**

Set the values in the range from  $-9.9999E+30$  to  $9.9999E+30$ .

**Note**

- If a channel of an element that has no module installed is used as an operand in the equation, the operand is handled as a zero.
- An Equation (Math1 or Math2) cannot be placed inside another equation (Math1 or Math 2).
- The equation of Math1 or Math2 cannot be placed inside the equation of a user-defined function.
- The TREND waveform (including TRENDM, TRENDD, and TRENDF) of the waveform displayed at the ends of the screen that is less than one period is not displayed. The TREND waveform is displayed over one period of the waveform.
- On products (PZ4000) with firmware version before 2.01, a coefficient cannot be multiplied to the result of TREND and FFT functions ( $2*\text{TREND}$  or  $3*\text{FFT}$ , for example). On products (PZ4000) with firmware version 2.01 or later, a coefficient cannot be multiplied to the result of a FFT function ( $3*\text{FFT}$ , for example).
- When the computation region or the equation is changed, do a re-computation. For information pertaining to changing the computation region and re-computation, see section 11.1.
- You can also set whether or not to display the upper and lower limits (ON/OFF). For the procedures related to turning ON/OFF the display, see section 9.6, "Turning ON/OFF the Upper and Lower Limit Displays."
- When the time base is set to external clock or when the measurement mode is set to harmonic, the TINTG function performs computation by considering one sampled data point as one-second data.
- The [Mode] of the waveform computation as well as [Math1] and [Math2] cannot be turned [ON] when averaging (see section 10.5) is turned [ON].



# 11.3 Performing the FFT

«For a functional description, see section 1.8.»

## Keys

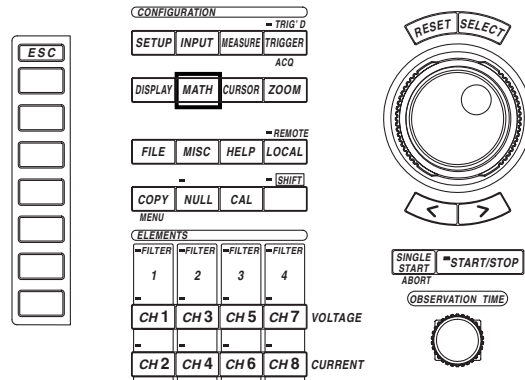

- The  mark indicates the keys that are used for the operation.
- To exit the menu during operation, press the ESC key.

## Procedure

1. Press the MATH key to display the Math setting menu.
2. Press the [Mode] soft key to select [ON].

### Selecting the number of computed points

3. Press the [FFT Points] soft key to display the menu used to select the number of computed points.
4. Press one of the soft keys from [1000] to [10000] to select the number of points.

### Selecting the time window

3. Press the [FFT Window] soft key to display the time window selection menu.
4. Press the [Rect] or [Hanning] soft key to select the time window.

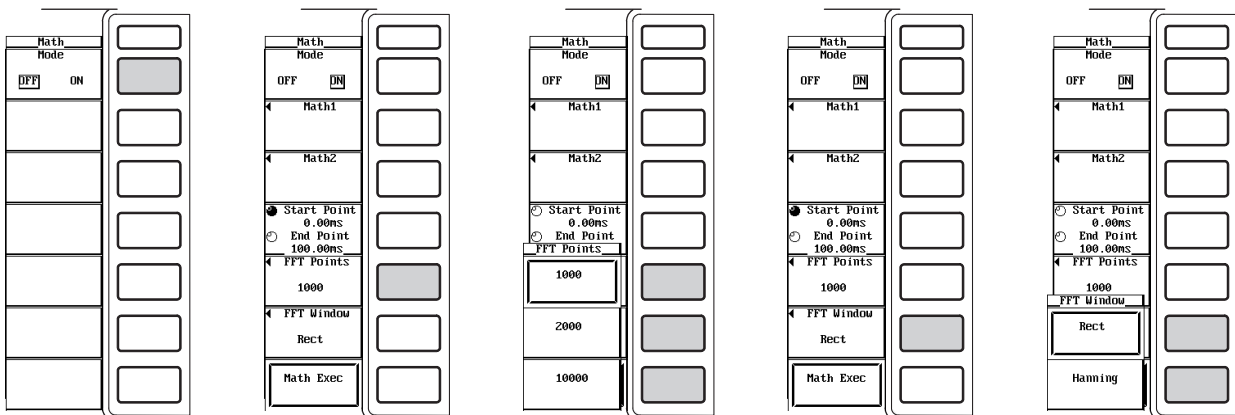

**Explanation**

The power spectrum of the voltage, current, and active power can be displayed by taking the FFT (Fast Fourier Transform). You can check the frequency distribution of the voltage, current, and active power from the result. For example, if the equation is set to FFT(C1) when setting the equation as described in section 11.2, the FFT of CH1 is performed. For a detailed explanation of the FFT, see section 1.8, "Waveform Analysis."

**Operand**

C1 to C8, which correspond to CH1 to CH8, can be used as operands when constructing the equation as described in section 11.2. For FFT functions, only one operand can be used from the following: C1 to C8, C1\*C2, C3\*C4, C5\*C6, or C7\*C8.

**Selecting the number of computed points**

Select the number of points from the following choices. The FFT is taken over the specified number of points from the start point of the waveform computation set in section 11.1.

1000, 2000, 10000

**Selecting the time window**

Select the time window from the following choices.

- Rect  
The time window is set to a rectangular window. This window is best suited to transient signals such as impulse waves in which the signal attenuates completely inside the window.
- Hanning  
The time window is set to a hanning window. This window is best suited to continuous signals.

**Note**

- The FFT cannot be performed when the display record length is less than the number of computed points.
- If a channel of an element that has no module installed is used as an operand in the equation, the computation result displays [-----] (no data).
- The maximum frequency displayed on the horizontal axis of the FFT display is the Nyquist frequency, which is half the frequency of the module's sampling rate. When the measurement is made at rates of 5 MS/s and 100 kS/s, the displayed frequencies are 2.5 MHz and 50 kHz, respectively. If the input signal contains a frequency component that is higher than half the sampling rate, aliasing occurs. Note that a display containing an aliased signal does not represent data that are actually measured.

# 11.4 Measuring with the Cursor

«For a functional description, see section 1.8.»

## Keys

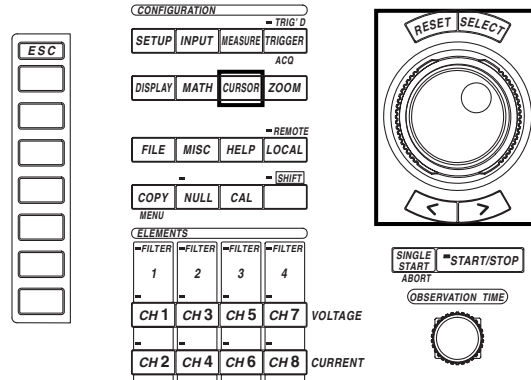

- The  mark indicates the keys that are used for the operation.
- To exit the menu during operation, press the ESC key.

## Procedure

1. Press the CURSOR key to display the Cursor setting menu.
2. Press the [Type] soft key to display the cursor type selection menu.
3. Press one of the soft keys from [Marker] to [H & V] to select the cursor type.
  - If you selected [Marker], go to step 4 on page 11-11.
  - If you selected [Horizontal], go to step 4 on page 11-13.
  - If you selected [Vertical], go to step 4 on page 11-14.
  - If you selected [H & V], go to step 4 on page 11-15.

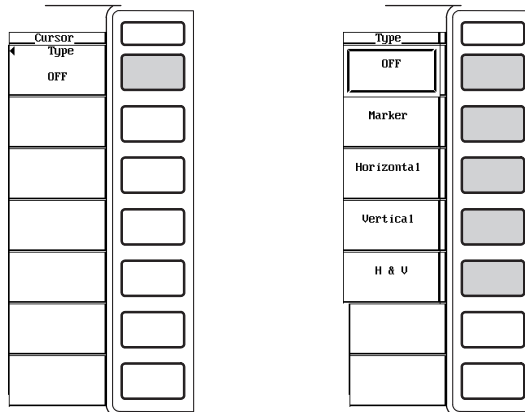

## When [Marker] is Selected

### Selecting the waveform on which to place the marker

#### • Selecting the waveform on which to place the + marker

4. Press the [Cursor1 Trace] soft key to display the box used to select the waveform on which to place the marker.
5. Turn the jog shuttle to select the waveform from [CH1] to [Math2].
6. Press the SELECT key to confirm the selection.

#### • Selecting the waveform on which to place the × marker

7. Press the [Cursor2 Trace] soft key to display the box used to select the waveform on which to place the marker.
8. Turn the jog shuttle to select the waveform from [CH1] to [Math2].
9. Press the SELECT key to confirm the selection.

### Moving the marker

#### • Moving the + marker

10. Press the [Cursor1 + / Cursor2 ×] soft key to set the jog shuttle control to [Cursor1 +].
11. Turn the jog shuttle to move the + marker.

#### • Moving the × marker

12. Press the [Cursor1 + / Cursor2 ×] soft key to set the jog shuttle control to [Cursor2 ×].
13. Turn the jog shuttle to move the × marker.

#### • Moving the + and × markers simultaneously

14. Press the [Cursor1 + / Cursor2 ×] soft key to set the jog shuttle control to both [Cursor1 +] and [Cursor2 ×].
15. Turn the jog shuttle to move the + and × markers simultaneously. The distance between them is kept constant.

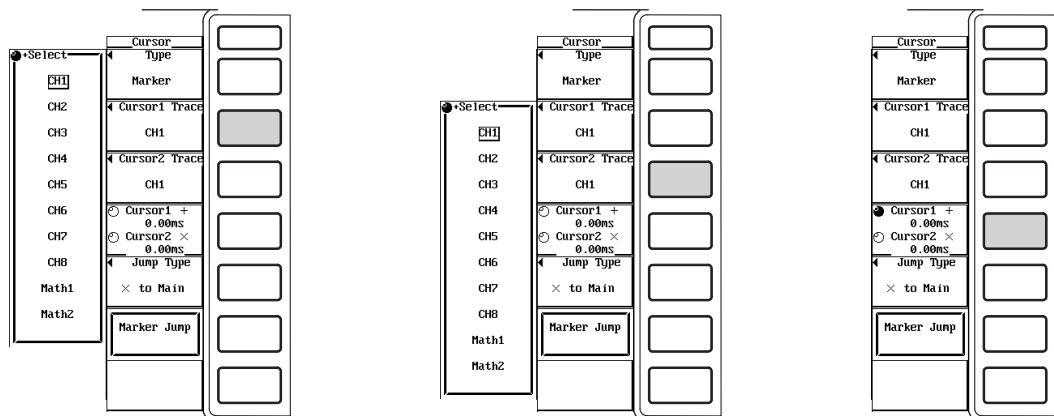

## 11.4 Measuring with the Cursor

### Making the marker (+, ×) jump to the center of the waveform display frame

16. Press the [Jump Type] soft key to display the jump selection menu.
17. Press one of the soft keys from [+ to Main] to [× to Z2] to select the marker and the jump destination.
18. Press the [Marker Jump] soft key to make the selected marker move to the jump destination.

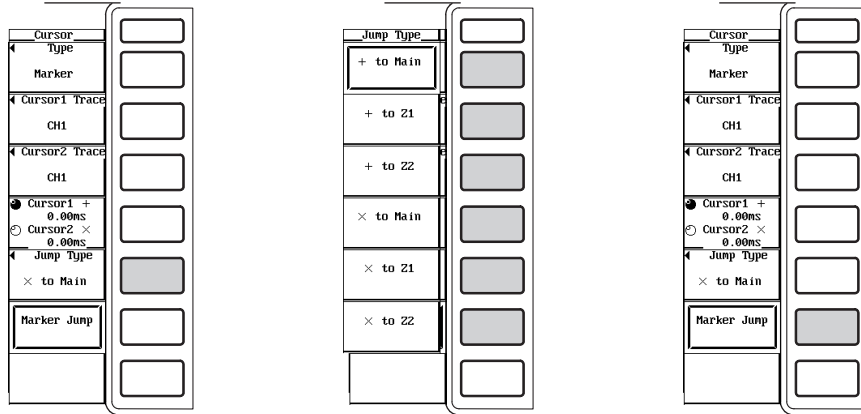

## When [Horizontal] is Selected

### Selecting the waveform on which to place the H cursor

4. Press the [Cursor1 Trace] soft key to display the box used to select the waveform on which to place the H cursor.
5. Turn the jog shuttle to select the waveform from [CH1] to [Math2].
6. Press the SELECT key to confirm the selection.

### Moving the H cursor

#### • Moving H cursor 1

7. Press the [Cursor1 = / Cursor2 =] soft key to set the jog shuttle control to [Cursor1 =].
8. Turn the jog shuttle to move H cursor 1.

#### • Moving H cursor 2

9. Press the [Cursor1 = / Cursor2 =] soft key to set the jog shuttle control to [Cursor2 =].
10. Turn the jog shuttle to move H cursor 2.

#### • Moving H cursor 1 and 2 simultaneously

11. Press the [Cursor1 = / Cursor2 =] soft key to set the jog shuttle control to both [Cursor1 =] and [Cursor2 =].
12. Turn the jog shuttle to move H cursor 1 and 2 simultaneously. The distance between them is kept constant.

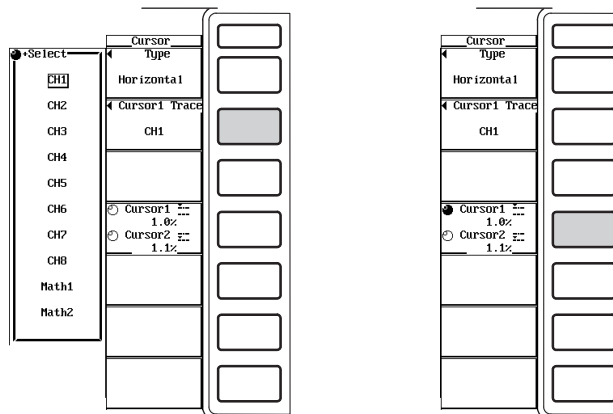

### When [Vertical] is Selected

#### Selecting the waveform on which to place the V cursor

4. Press the [Cursor1 Trace] soft key to display the box used to select the waveform on which to place the V cursor.
5. Turn the jog shuttle to select the waveform from [CH1] to [Math2].
6. Press the SELECT key to confirm the selection.

#### Moving the V cursor

##### • Moving V cursor 1

7. Press the [Cursor1 | | / Cursor2 | |] soft key to set the jog shuttle control to [Cursor1 | |].
8. Turn the jog shuttle to move V cursor 1.

##### • Moving V cursor 2

9. Press the [Cursor1 | | / Cursor2 | |] soft key to set the jog shuttle control to [Cursor2 | |].
10. Turn the jog shuttle to move V cursor 2.

##### • Moving V cursor 1 and 2 simultaneously

11. Press the [Cursor1 | | / Cursor2 | |] soft key to set the jog shuttle control to both [Cursor1 | |] and [Cursor2 | |].
12. Turn the jog shuttle to move V cursor 1 and 2 simultaneously. The distance between them is kept constant.

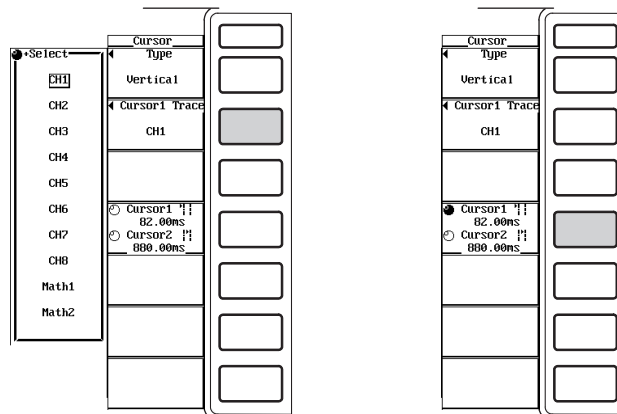

## When [H & V] is Selected

### Selecting the waveform on which to place the H and V cursors

4. Press the [Cursor1 Trace] soft key to display the box used to select the waveform on which to place the V cursor.
5. Turn the jog shuttle to select the waveform from [CH1] to [Math2].
6. Press the SELECT key to confirm the selection.

### Moving the H cursor

#### • Moving H cursor 1

7. Press the [Cursor1 = / Cursor2 =] soft key to set the jog shuttle control to [Cursor1 =].
8. Turn the jog shuttle to move H cursor 1.

#### • Moving H cursor 2

9. Press the [Cursor1 = / Cursor2 =] soft key to set the jog shuttle control to [Cursor2 =].
10. Turn the jog shuttle to move H cursor 2.

#### • Moving H cursor 1 and 2 simultaneously

11. Press the [Cursor1 = / Cursor2 =] soft key to set the jog shuttle control to both [Cursor1 =] and [Cursor2 =].
12. Turn the jog shuttle to move H cursor 1 and 2 simultaneously. The distance between them is kept constant.

### Moving the V cursor

#### • Moving V cursor 1 (Cursor3 | I)

13. Press the [Cursor3 | I / Cursor4 | I] soft key to set the jog shuttle control to [Cursor3 | I].
14. Turn the jog shuttle to move V cursor 1.

#### • Moving V cursor 2 (Cursor4 | I)

15. Press the [Cursor3 | I / Cursor4 | I] soft key to set the jog shuttle control to [Cursor4 | I].
16. Turn the jog shuttle to move V cursor 2.

#### • Moving V cursor 1 and 2 simultaneously

17. Press the [Cursor3 | I / Cursor4 | I] soft key to set the jog shuttle control to both [Cursor3 | I] and [Cursor4 | I].
18. Turn the jog shuttle to move V cursor 1 and 2 simultaneously. The distance between them is kept constant.

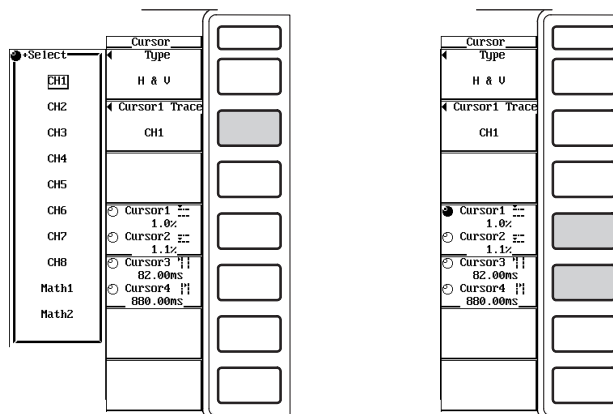



### Explanation

By placing markers or cursors on the displayed waveform, the data defined by that point can be measured and displayed. It can be used to measure the voltage and current for various sections of the waveform or the corresponding horizontal axis (X axis) data.

#### Waveforms that can be measured

Select the waveform to be measured using the cursor from the following choices.  
CH1 to CH8, Math1, Math2

#### Marker and cursor types and measured items

- **Marker**

“+” and “x” marks are displayed on the specified waveform. The vertical value (Y-axis value) and the horizontal value from the left edge of the screen (X-axis value) of each marker can be measured. The differences between the Y-axis values and between the X-axis values can also be measured. The marker moves along the waveform and measures the value of the waveform data.

+ marker (Cursor1) and x marker (Cursor2) can be set on different waveforms.

Y+ : Y-axis value of Cursor1

Yx : Y-axis value of Cursor2

$\Delta Y$  : The difference between the Y-axis values of Cursor1 and Cursor2

X+ : X-axis value of Cursor1

Xx : X-axis value of Cursor2

$\Delta X$  : The difference between the X-axis values of Cursor1 and Cursor2

$1/\Delta X$  : The inverse of the difference between the X-axis values of Cursor1 and Cursor2

- **H cursor (Horizontal)**

Two H cursors are displayed horizontally. The vertical value (Y-axis value) at the cross point between the H cursor and the waveform and the difference in the Y-axis values of the H cursors can be measured. The two H cursors are set on the same waveform.

Y1 : Y-axis value of Cursor1

Y2 : Y-axis value of Cursor2

$\Delta Y$  : The difference between the Y-axis values of Cursor1 and Cursor2

- **V cursor (Vertical)**

Two V cursors are displayed vertically. The horizontal value from the left edge of the screen to each V cursor (X-axis value) and the difference in the X-axis values of the V cursors can be measured. The two V cursors are set on the same waveform.

X1 : X-axis value of Cursor1

X2 : X-axis value of Cursor2

$\Delta X$  : The difference between the X-axis values of Cursor1 and Cursor2

$1/\Delta X$  : The inverse of the difference between the X-axis values of Cursor1 and Cursor2

- **H&V cursor (H&V)**

H cursors (Cursor1, Cursor2) and V cursors (Cursor3, Cursor4) are displayed. The X-axis values and Y-axis values of each cursor can be measured. The four cursors are set on the same waveform.

Y1 : Y-axis value of Cursor1

Y2 : Y-axis value of Cursor2

$\Delta Y$  : The difference between the Y-axis values of Cursor1 and Cursor2

X1 : X-axis value of Cursor3

X2 : X-axis value of Cursor4

$\Delta X$  : The difference between the X-axis values of Cursor3 and Cursor4

$1/\Delta X$  : The inverse of the difference between the X-axis values of Cursor3 and Cursor4

---

**Note**

- When the measurement mode is harmonic and the time base is set to internal clock, the unit of the horizontal axis becomes frequency (Hz) if the waveform on which to place the marker is set to Math1 or Math2 that is computing FFTs. The converting equation is as follows:  
 $f[\text{Hz}] = f_s \times N / (\text{Max Order})$       where  $f_s$  is the sampling rate (see appendix 1),  $N$  the harmonic order, and Max Order the maximum harmonic order under analysis (see section 10.7).
  - When the measurement mode is normal or harmonic and the time base is set to external clock, the unit of the horizontal axis becomes harmonic order if the waveform on which to place the marker is set to Math1 or Math2 that is computing FFTs.
  - $\Delta Y$ ,  $\Delta X$ , and  $1/\Delta X$  are computed when the units for Cursor1 and Cursor2 are the same (time or frequency, for example).
-

**Movement range of the marker**

- The markers move along the selected waveform. When the measurement mode is normal and the time base is set to internal clock, the marker can be moved in the range from 0 s (the left end of the screen) to the observation time (the right end of the screen). When the time base is set to external clock or when the measurement mode is harmonic, the marker can be moved in the range defined by the number of data points in the record length. For example, if the record length is 100 k-words, then the range is from data point 0 (the left end of the screen) to data point 100 k (the right end of the screen).
- When the measurement mode is normal and the time base is set to internal clock, the marker can be set in steps of (observation time ÷ display record length). When the time base is set to external clock or when the measurement mode is harmonic, the marker can be set in steps of one data point.
- To move the two markers while keeping the distance between them constant, the jog shuttle must be set to control both markers.
- When two values, maximum and minimum values, are displayed on the same time axis, the points are measured in the order of the sampled data as shown in the diagram below.

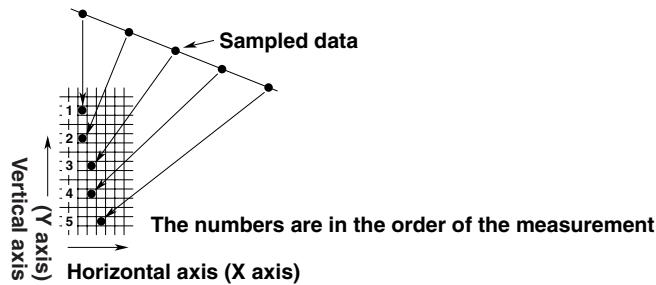

**Movement range of the H cursor**

- With the center of the waveform display frame set as the zero amplitude line, the range is from the top (100.0%) to the bottom (-100.0%) of the screen.
- The H cursor position can be set in steps of 0.1%.
- To move the two cursors while keeping the distance between them constant, the jog shuttle must be set to control both cursors.

**Movement range of the V cursor**

- When the measurement mode is normal and the time base is set to internal clock, the V cursor can be moved in the range from 0 s (the left end of the screen) to the observation time (the right end of the screen). When the time base is set to external clock or when the measurement mode is harmonic, the V cursor can be moved in the range defined by the number of data points in the record length. For example, if the record length is 100 k-words, then the range is from data point 0 (the left end of the screen) to data point 100 k (the right end of the screen).
- When the measurement mode is normal and the time base is set to internal clock, the V cursor can be set in steps of (observation time ÷ display record length). When the time base is set to external clock or when the measurement mode is harmonic, the V cursor can be set in steps of one data point.
- To move the two cursors while keeping the distance between them constant, the jog shuttle must be set to control both cursors.

**Making the marker jump inside the main or zoom waveform display frame**

When displaying the zoomed waveform or when the display record length is shorter than the record length, the marker sometimes goes out of the waveform display frame. In such cases, the marker can be jumped back to the center of the display frame. The markers can be jumped in the following ways.

- + to Main  
Jump marker + (Cursor 1) to the center of the main waveform display frame.
- + to Z1  
Jump marker + (Cursor 1) to the center of the Z1 zoom waveform display frame.
- + to Z2  
Jump marker + (Cursor 1) to the center of the Z2 zoom waveform display frame.
- × to Main  
Jump marker × (Cursor 2) to the center of the main waveform display frame.
- × to Z1  
Jump marker × (Cursor 2) to the center of the Z1 zoom waveform display frame.
- × to Z2  
Jump marker × (Cursor 2) to the center of the Z2 zoom waveform display frame.

**Cursor measurements of X-Y waveforms**

- The types of markers and cursors and the measurement items are the same as the T-Y waveform (normal waveform).
- The movement range of markers and H cursors are the same as the T-Y waveform.
- The range of the V cursor is from the right edge (100.0%) to the left edge (–100.0%) of the screen with the center of the X-Y waveform display frame set as zero. The selectable steps and the procedure to move the two cursors are the same as for the T-Y waveform.
- Cursor measurements can be performed on the active display format of the X-Y waveform. However, when the display format is [Wave+X-Y], the V cursor on the X-Y waveform cannot be moved. This is because the unit of the V cursor on the T-Y waveform (time) is different from that of the V cursor on the X-Y waveform (voltage, current, etc.).
- When the marker is set to a waveform trace that is assigned to the X-axis (set using the [Cursor1 Trace] menu), the marker will not be displayed because the waveform on which to move the cursor cannot be uniquely determined.
- When the H cursor is set to a waveform trace that is assigned to the X-axis (set using the [Cursor1 Trace] menu), the cursor will not be displayed because there are no data along the Y-axis.
- When the V cursor is set to a waveform trace that is assigned to the X-axis (set using the [Cursor1 Trace] menu), the cursor will not be displayed because there are no data along the Y-axis.
- The waveform on which the V cursor is placed is fixed to the waveform trace that is assigned to the X-axis.

**Note**

- The cursors can be set when only the numerical data are being displayed. However, since the original T-Y waveform is not displayed, the positions cannot be confirmed. Change the display format in order to check the cursor positions. However, for X-Y waveforms, the V cursor on the X-Y waveform will not move when the T-Y waveform is also displayed.
- Cursors cannot be placed on waveforms corresponding to a channel of an element that has no module installed.
- The time axis value is measured from the left edge of the screen.
- When there are data that cannot be measured, "\*\*\*\*" is displayed in the measured value display area.
- When the marker is outside the waveform display frame, only the values related to the time axis are displayed.

## 12.1 Precautions on the Use of the Floppy Drive

### Floppy Disks that can be Used

The following types of 3.5-inch floppy disks can be used. The floppy disk can be formatted using the instrument.

- 2HD: 1.2 MB or 1.44 MB (MS-DOS format)
- 2DD: 640 KB or 720 KB (MS-DOS format)

### Inserting the Floppy Disk into the Drive

With the label side facing left, insert the floppy disk into the floppy disk drive. Insert the disk until the eject button pops up.

### Removing the Floppy Disk from the Drive

Check that the access indicator is OFF, then press the eject button.

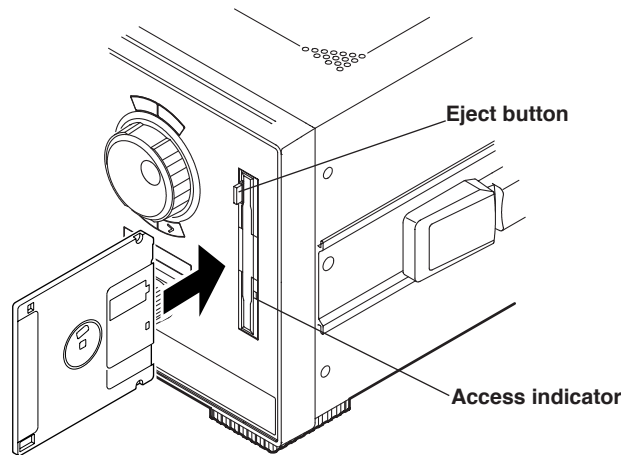

### CAUTION

Removing the floppy disk while the access indicator is blinking can damage the magnetic head of the drive and destroy the data on the floppy disk.

### General Handling Precautions of the Floppy Disk

For the general handling precautions of the floppy disk, see the instructions that came with the floppy disk.

## 12.2 Connecting SCSI Devices

### SCSI Specifications (Option)

Item	Specifications
Interface standard	SCSI(Small Computer System Interface), ANSI X3.131-1986
Connector type	50-pin half pitch (pin type)
Electrical specifications	Single-ended. See the chart below for pin assignments. A terminator is built-in.

Pin No.	Signal Name	Pin No.	Signal Name
1 to 12	GND	38	TERMPWR
13	NC	39, 40	GND
14 to 25	GND	41	-ATN
26	-DB0	42	GND
27	-DB1	43	-BSY
28	-DB2	44	-ACK
29	-DB3	45	-RST
30	-DB4	46	-MSG
31	-DB5	47	-SEL
32	-DB6	48	-C/D
33	-DB7	49	-REQ
34	-DBP	50	-I/O
35 to 37	GND	-	-

### Necessities when connecting a SCSI device

#### SCSI cable

Use a commercially sold cable that is 3 m or less in length, that has a ferrite core on each end of the cable, and that has a characteristic impedance between 90 and 132  $\Omega$ .

### Connection Procedure

1. Connect the SCSI cable to the SCSI connector on the back of the instrument.
2. Turn ON the SCSI device and this instrument.  
To format a medium, follow the steps given in section 12.4, "Formatting the Disk."

#### SCSI devices that can be connected

Most SCSI devices (MO disk drive, hard disk, and ZIP) can be connected to the instrument, but there are some exceptions. For example, the maximum number of partitions that can be selected is ten<sup>\*1</sup> and each partition cannot exceed 2 GB. If the total capacity of all partitions exceeds 20 GB<sup>\*2</sup>, the hard disk cannot be formatted. For general handling precautions for the connected SCSI device, see the instruction manual that is provided with the device.

\*1 "5" for products (PZ4000) with firmware version before 2.01.

\*2 "10GB" for products (PZ4000) with firmware version before 2.01.

#### Note

When connecting multiple SCSI devices in a chain, attach a SCSI terminator to the device at the other end of the chain.

## 12.3 Changing the SCSI ID Number

### Keys

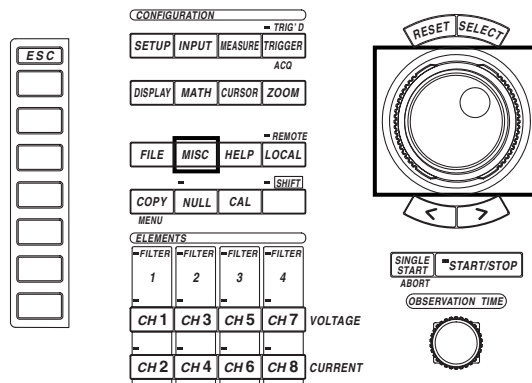

- The  mark indicates the keys that are used for the operation.
- To exit the menu during operation, press the ESC key.

### Procedure

1. Press the MISC key to display the Misc setting menu.
2. Press the [SCSI ID] soft key to display the SCSI number setting menu.
3. Press the [Own ID] soft key.
4. Turn the jog shuttle to select the ID from [0] to [7].
5. Press the [Initialize SCSI] soft key to change the SCSI ID to the selected ID number.

An  icon blinks in the upper right corner of the screen while the ID is being changed. The icon disappears when the changes are complete.

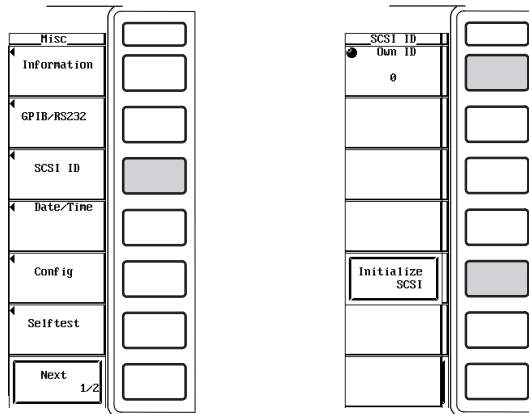

## 12.3 Changing the SCSI ID Number

---

### Explanation

The SCSI ID number is used to distinguish between the various devices connected to the SCSI chain. Make sure not use duplicate ID numbers on any of the connected devices. SCSI is an option.

### Range of SCSI ID numbers

Select the OWN ID (PZ4000) in the range from 0 to 7. The default value is 6.

### Note

- Assign numbers that are different from the ID number of the instrument for the external SCSI devices.
- When changing the SCSI ID number, make sure to press the [Initialize SCSI] soft key.
- The ID numbers of the external SCSI devices are automatically identified.

### Procedure to connect the PZ4000, SCSI device, and PC via SCSI

1. Check that the power switch of the PZ4000, SCSI device, and PC are OFF.
2. Connect the PZ4000 and the SCSI device and connect the SCSI device and the PC using SCSI cables.
3. Turn ON the SCSI device and then the PZ4000.
4. After the PZ4000 boots up, check that the PZ4000 detects the connected SCSI device.  
(Press the keys in the following sequence: File key, [Utility] soft key, [Function] soft key, and [Delete] soft key. The File List dialog box appears.) Check that the name of the medium inserted in the SCSI device appears in the File List dialog box.)
5. Turn ON the PC.



### Note

Note that the PZ4000 will not operate properly, if the PZ4000 is connected directly to a PC via SCSI cable without going through a SCSI device.

### About the files created using the PZ4000 over the SCSI connection

In some cases, the PC will not recognize a new file that is created by the PZ4000 on the SCSI device while the PZ4000, SCSI device, and PC are connected. In such case, reconnect the devices according to the procedures given in “Procedure to connect the PZ4000, SCSI device, and PC via SCSI” (see above).

However, if the PC is running Windows 95/98, the files will be recognized by taking the following steps.

1. On Windows 95/98, open the [Settings] tab in the [Properties] dialog box for the connected drive, and select the [Removable] check box.
  - \* Select [My Computer] → [Control Panel] → [System] → [Device Manager] → [Disk Drive]. Select the relevant drive from the drive list that appears when [Disk Drive] is opened. Open the [Properties] dialog box of the selected drive and select the [Settings] tab. A dialog box containing the [Removable] check box appears. The drive letter of the selected drive is displayed under [Current Drive] in the dialog box.
2. Reboot the PC.
3. After creating a new file with the PZ4000, select “Refresh” in the file list window (Explorer, for example).



# 12.4 Formatting the Disk

## Keys

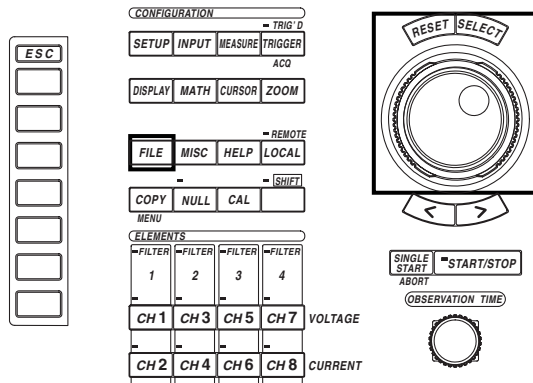

- The  mark indicates the keys that are used for the operation.
- To exit the menu during operation, press the ESC key.

## Procedure

1. Press the FILE key to display the File setting menu.
2. Press the [Utility] soft key to display the Utility setting menu and the File List dialog box.
3. Press the [Function] soft key to display the file function selection menu.

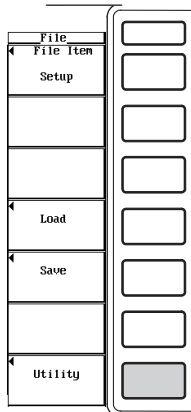

File List		
File Name	Size	Space
FD0	1457664	1307000
SC0	2146009000	2012315640

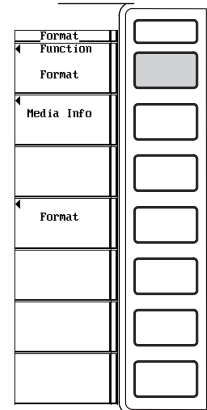

## 12.4 Formatting the Disk

### Selecting the medium to be formatted

- Press the [Format] soft key. A list of media is displayed in the File List dialog box.
- Turn the jog shuttle to select the medium to be formatted.  
If no external SCSI devices are identified and a floppy disk is inserted in the floppy disk drive, only [FD0] is displayed.

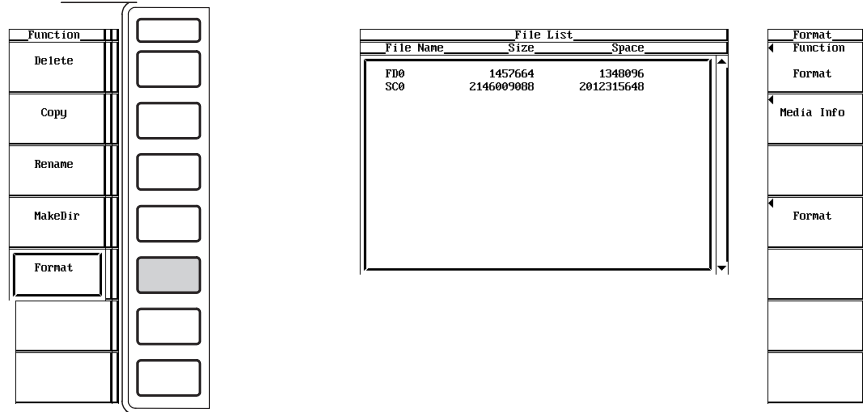

### Selecting the FD format

- Press the [Format] soft key to display the format selection menu.
- Turn the jog shuttle to select the format from [2DD 640K] to [2HD 1.44M].

Go to step 9.

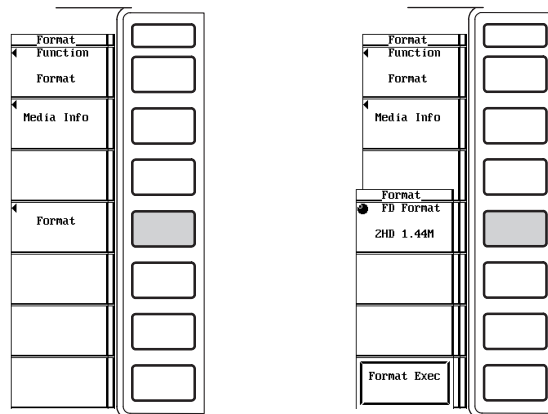

**Selecting the format type for the SCSI device**

6. Press the [Format] soft key to display the format selection menu.

- **Selecting the number of partitions**

7. Turn the jog shuttle to select the number from [1] to [10].

\* "5" for products (PZ4000) with firmware version before 2.01.

- **Selecting the format type**

8. Press the [Format Type] soft key to select [Normal] or [Quick].

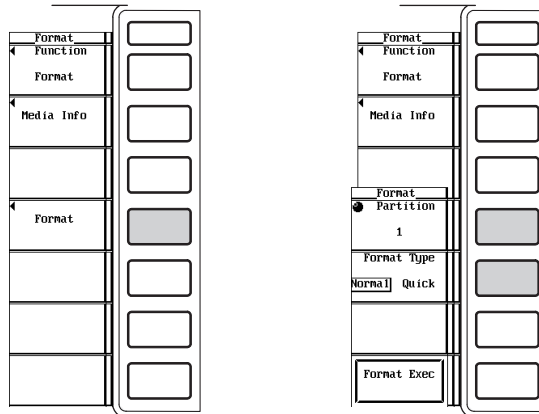
**Executing and Canceling the format operation**

9. Press the [Format Exec] soft key. An Alert dialog box is displayed.

10. Turn the jog shuttle to select [OK] or [Cancel].

11. Selecting [OK] and pressing the SELECT key executes the format operation. Selecting [Cancel] and pressing the SELECT key will not format the medium.

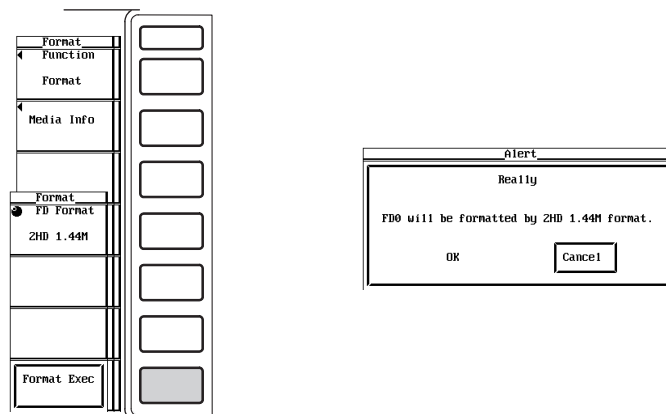
**Viewing the information about the medium**

6. Press the [Media Info] soft key to display the information about the medium that was selected in step 5.

### Explanation

---

#### CAUTION

- Never remove the medium (disk) or turn OFF the power while the access indicator or the  mark is blinking. It can damage the medium or destroy the data on the medium.
  - When the instrument cannot read a pre-formatted medium, reformat the medium on the instrument. Make sure to back up important data before formatting the medium. All data will be erased.
- 

#### Formatting a floppy disk

When using a new floppy disk, you must format it first. Select the appropriate format for the floppy disk from the following choices.

- 2DD 640K  
Formats the 2DD floppy disk to 640 KB/8 sectors.
- 2DD 720K  
Formats the 2DD floppy disk to 720 KB/9 sectors.
- 2HD 1.2M  
Formats the 2HD floppy disk to 1.2 MB/8 sectors.
- 2HD 1.44M  
Formats the 2HD floppy disk to 1.44 MB/18 sectors.

#### Formatting a disk

The formats of media connected via SCSI (option) are as follows.

- MO/PD  
Semi-IBM format. Handled as removable disk.
- ZIP/JAZ  
Hard disk format. Handled as fixed disk.

#### Hard disk format

The hard disk format is IBM compatible format.

#### Selecting the format mode

When formatting a medium in an external SCSI device, the following two format modes are available.

- Normal  
Executes physical format and logical format.
- Quick  
Executes only the logical format.

The estimated time it takes to format a medium is as follows. (The time varies depending on the SCSI device.)

Medium	Normal	Quick
MO (128 MB)	Approx. 10 min	Approx. 15 s
MO (230 MB)	Approx. 10 min	Approx. 15 s
External HDD (1 GB)	Approx. 20 min	Approx. 15 s

### Selecting the number of partitions

- The external hard disk can be divided into several partitions for use.
- Select the number of partitions in the range from 1 to 10\*. If the number of partitions is set to "2," the hard disk is divided into two partitions named "SC0" and "SC1."
  - \* "5" for products (PZ4000) with firmware version before 2.01.
- When formatting a large hard disk, select the number of partitions so that each partition does not exceed 2 GB.
- If the total capacity of all partitions exceeds 20 GB\*, the hard disk cannot be formatted.
  - \* "10GB" for products (PZ4000) with firmware version before 2.01.
- The selection of the number of partitions only applies to hard disk storage devices. For all other devices, it is handled as one partition.

### Information about the medium

The following information is listed for the selected medium.

- Media Name : Name of the medium
- Media Size : Total capacity
- Used Space : Used space
- Vacant Space : Free space
- Partition Size : Number of partitions

If you press the [Media Info] soft key when an MS-DOS formatted floppy disk is inserted in the floppy disk drive, the information about the floppy disk is displayed.

### Note

- Formatting a medium containing data erases the data completely.
- The time it takes to format a floppy disk is approximately one and a half minutes.
- A floppy disk cannot be formatted if it is write protected.
- Never format when the instrument is connected to a PC via a SCSI cable.
- Floppy disks having a format other than the ones listed in this section cannot be used.
- If an error message appears after the format operation, the floppy disk may be damaged.
- Disks formatted to MS-DOS format on a PC can also be used.
- The Quick (logical) format only clears (initializes) the directory entry and FAT information. If you need to check for bad tracks, do a physical format (Normal).
- When data are written to an external SCSI device that has bad tracks, an access error (604 Media failure) may occur in which case no more data can be written. When you are using a medium for the first time or if the medium can no longer be read, do a "Normal" format. If you want to format a disk that you have been using before, do a "Quick" format.
- On products (PZ4000) with firmware version 2.01 or later, quick format of DVD-RAM is possible. Physical format (Normal) is not possible.

## 12.5 Saving and Loading Setup Parameters

### Keys

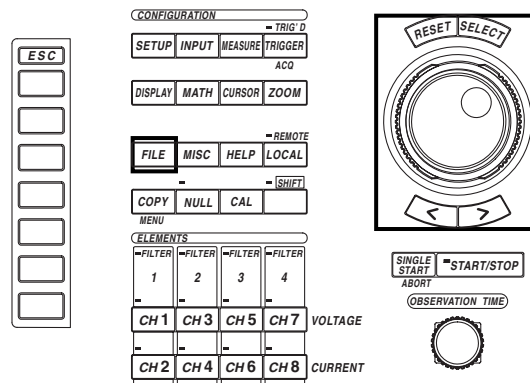

- The  mark indicates the keys that are used for the operation.
- To exit the menu during operation, press the ESC key.

### Procedure

1. Press the FILE key to display the File setting menu.
2. Press the [File Item] soft key to display the File Item setting menu.
3. Press the [Setup] soft key.

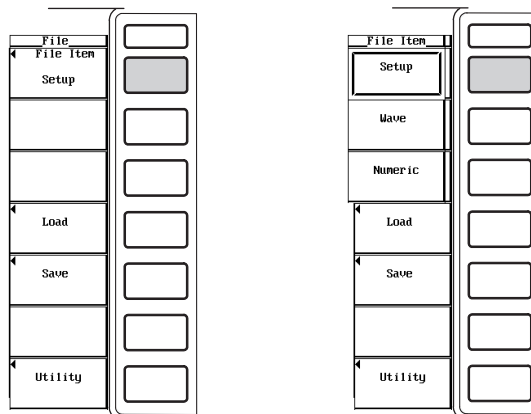

### Saving the Setup Parameters

- Press the [Save] soft key to display the save setting menu.

#### Selecting the destination medium

- Press the [File List] soft key to display the File List dialog box.
- Turn the jog shuttle to select the destination medium (displayed with [ ]).
- Press the SELECT key to confirm the selection.

#### Selecting the destination directory

(When there are directories on the medium)

- Turn the jog shuttle to select the destination directory (displayed with <>).
- Press the SELECT key to confirm the selection.

The [Path=.....] box on the top left corner of the File List dialog box displays the selected medium and directory.

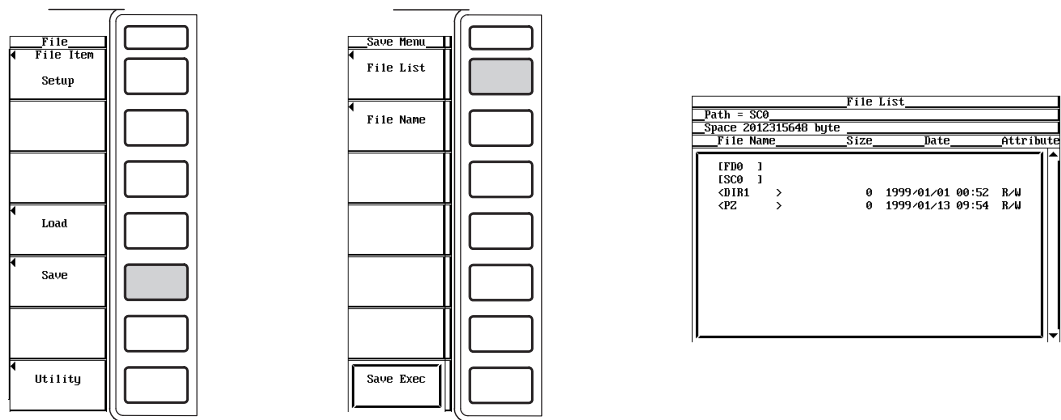

#### Setting the file name and comment

- Press the [File Name] soft key to display the file name setting dialog box.
- Turn the jog shuttle to select [Auto Naming].
- Press the SELECT key to select [ON] or [OFF].
- Turn the jog shuttle to select [File Name].
- Press the SELECT key. A keyboard appears.
- Use the keyboard to enter the file name.  
For keyboard operation, see section 4.1, "Entering Values and Strings."
- Similarly, enter the [Comment].
- Press the ESC key to close the file name setting dialog box.

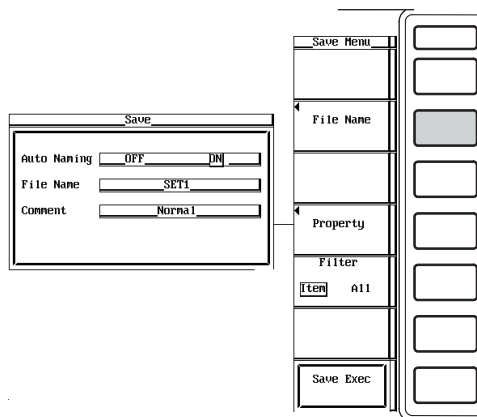

## 12.5 Saving and Loading Setup Parameters

### Saving the file

18. Press the [Save Exec] soft key to save the file to the directory indicated in [Path=.....]. The name of the [Save Exec] soft key changes to [Abort].

### Canceling the saving operation

19. Press the [Abort] soft key to cancel the save operation. The name of the [Abort] soft key changes to [Save Exec].

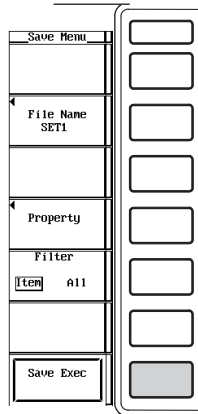

### Specifying the file to be displayed in the File List dialog box

10. Press the [Filter] soft key to select [Item] or [All].

### Viewing the properties

10. In the File List dialog box, turn the jog shuttle to select the desired file.
11. Press the [Property] soft key to display the property window of the file.
12. Press the ESC key to close the property window.

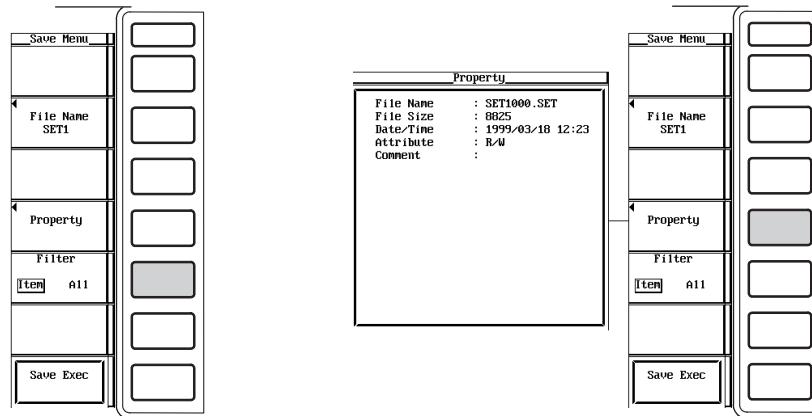



**Loading the Setup Parameters.**

4. Press the [Load] soft key to display the load setting menu and the File List dialog box.

**Selecting the source medium**

5. Turn the jog shuttle to select the source medium (displayed with [ ]).
6. Press the SELECT key to confirm the selection.

**Selecting the source directory**

**(When there are directories on the medium)**

7. Turn the jog shuttle to select the source directory (displayed with <>).
8. Press the SELECT key to confirm the selection.

The [Path=.....] box on the top left corner of the File List dialog box displays the selected medium/directory.

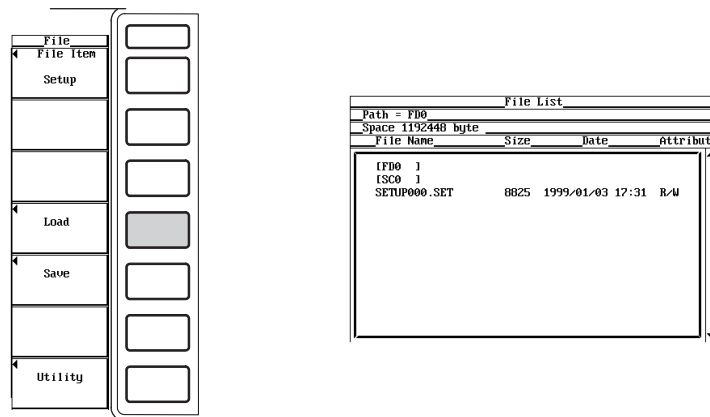

**Selecting the file to be loaded**

9. Turn the jog shuttle to select the file.

**Loading the file**

10. Press the [Load Exec] soft key to load the file from the directory indicated in [Path=.....]. The name of the [Load Exec] soft key changes to [Abort].

**Canceling the loading operation**

11. Press the [Abort] soft key to cancel the loading operation. The name of the [Abort] soft key changes to [Load Exec].

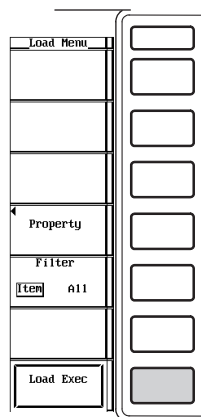

## 12.5 Saving and Loading Setup Parameters

---

### Specifying the file to be displayed in the File List dialog box

The procedures are the same as “Specifying the file to be displayed in the File List dialog box” on page 12-12.

### Viewing the properties

The procedures are the same as “Viewing the properties” on page 12-12.

### Explanation

---

#### CAUTION

Never remove the medium (disk) or turn OFF the power while the access indicator or the  mark is blinking. It can damage the medium or destroy the data on the medium.

---

### Setup Parameters that are saved

The setup parameters of each key existing at the time of the saving operation are saved. However, date and time, communication parameters, and SCSI ID numbers are not saved.

### Selecting the medium and directory

The media that are available are displayed in the File List dialog box.

### Examples

- [FD0] : Floppy disk
- [SC5] : SCSI device with an ID number of 5
- [SC5\_1] : The first partition of a SCSI device with an ID number of 5

### Data size

The data size corresponding to one set of setup parameters is approximately 20 KB.

### File name and comment

- You must specify a file name. Comment can be omitted.
- You cannot save to a file name that is already in use in the same directory (no overwriting).

### Number and types of characters that can be used

Item	Number of chars	Characters that can be used
File name	1 to 8 chars	0 to 9, A to Z, %, _, ( ) (parenthesis), -(minus sign)
Comment	0 to 25 chars	All characters (including spaces), The maximum length of the comment when saving a file is 20 characters.

### File extension

The File extension .set is automatically appended to the file.

### Auto naming function

When [Auto Naming] is turned ON, files with three digit numbers from 000 to 999 are automatically created. Specify the common name (maximum of five characters, specify at the Filename item) that is placed before the three digit number.

**Specifying the files to display in the File List dialog box**

You can specify the type of files to display.

- **Item**  
Displays only setup parameter files.
- **All**  
Displays all files on the medium.

**Properties**

Lists the file name, extension, file size, the date it was saved, the attribute, and the comment for the selected file.

**Note**

---

- You cannot save or load while the data acquisition is in progress (START/STOP indicator is ON).
  - If you change the file extension on a PC, for an example, you will not be able to load that file.
  - A maximum of 36 characters can be displayed in [Path].
  - For file names, upper and lower case letters are not distinguished. For comments, they are distinguished. In addition, the following file names cannot be used due to limitations of MS-DOS.  
AUX, CON, PRN, NUL, CLOCK
  - When using the GP-IB or serial interface commands to enter a file name, the following symbols that do not exist on the keyboard of this instrument can be used.  
{ }
  - When the setup parameters are loaded from a file, the setup parameters of each key are overwritten with the loaded settings and cannot be set back to their previous settings. It is recommended that the current setup parameters be saved before loading setup parameters from a file.
  - The date and time, communication parameters and SCSI ID numbers are not saved. Therefore, when setup parameters are loaded from a file, these parameters do not change.
  - The setup parameters cannot be loaded, if the record length or the module configuration differs from the setting that existed at the time the setup parameters were saved. This is also true if the setup parameters were saved using an incompatible version of firmware.
-

## 12.6 Saving and Loading Waveform Data

### Keys

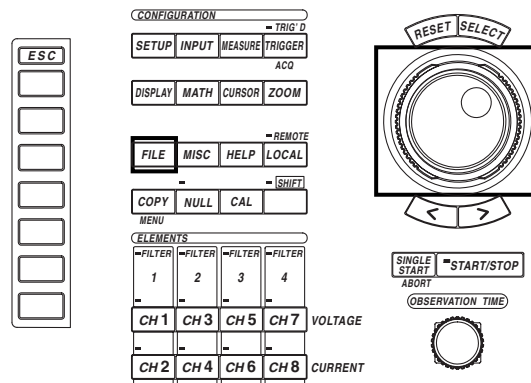

- The  mark indicates the keys that are used for the operation.
- To exit the menu during operation, press the ESC key.

### Procedure

1. Press the FILE key to display the File setting menu.
2. Press the [File Item] soft key to display the File Item setting menu.
3. Press the [Wave] soft key to select waveform data.

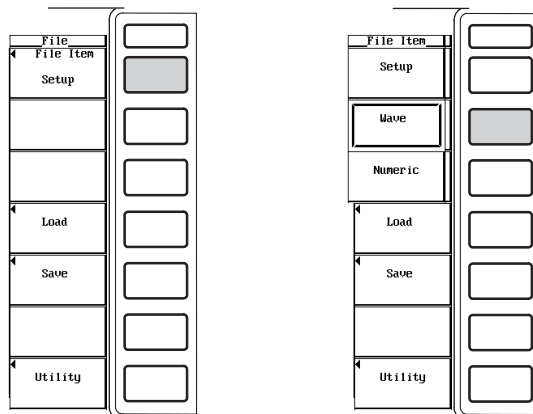

## Saving the Waveform Data

### Selecting the data type

4. Press the [Data Type] soft key to display the data type selection menu.
  5. Press one of the keys from [Binary] to [Float] to select the data type.
- \* Only the data that are saved in [Binary] can be loaded as described later.

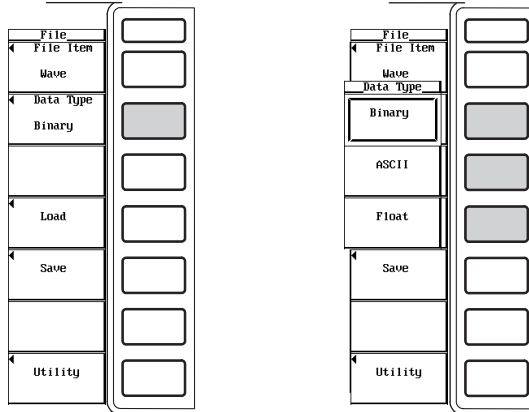

### Selecting the waveform to be saved

The waveform selection menu ([CH1] to [MATH2]) is displayed only when [Float] is selected in step 5. (If the data type is [Binary] or [ASCII], the displayed waveform is saved.)

6. Press the [Save] soft key to display the save setting menu.
7. Press the [Trace] soft key to display the waveform selection menu.
8. Press one of the soft keys from [CH1] to [Math2] to select the waveform to be saved.

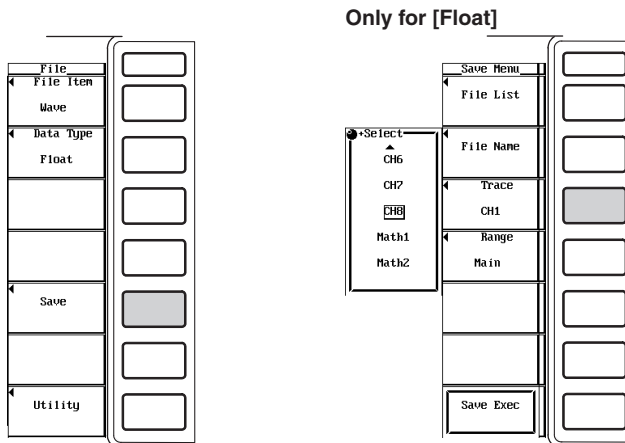

Only for [Float]

## 12.6 Saving and Loading Waveform Data

### Selecting the range of the waveform to be saved

9. Press the [Range] soft key to display the save range selection menu.
10. Press one of the soft keys from [Main] to [Z2] to select the range of the waveform to be saved.

\* Only the data that are saved for [Main] can be loaded as described later.

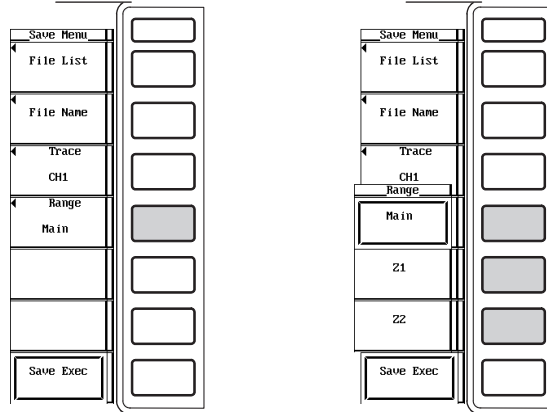

### Selecting the destination medium and directory

11. The procedures are the same as “Selecting the destination medium” and “Selecting the destination directory” in section 12.5.

### Setting the file name and comment

12. The procedures are the same as “Setting the file name and comment” in section 12.5.

### Saving the file

13. Press the [Save Exec] soft key to save the file to the directory indicated in [Path=.....]. The name of the [Save Exec] soft key changes to [Abort].

### Canceling the saving operation

14. Press the [Abort] soft key to cancel the saving operation. The name of the [Abort] soft key changes to [Save Exec].

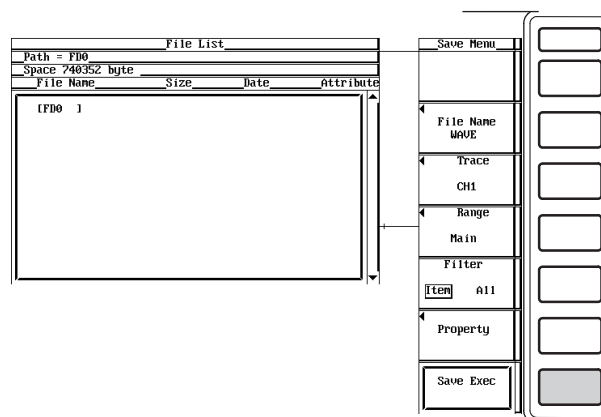

### Specifying the file to be displayed in the File List dialog box, viewing the properties

The procedures are the same as “Specifying the file to be displayed in the File List dialog box” and “Viewing the properties” in section 12.5.

### Loading the Waveform Data

Set the data type to [Binary]. For the procedures, see steps 4 and 5 in the paragraph “Saving the Waveform Data.”

4. Check that the [Data Type] is set to [Binary].
5. Press the [Load] soft key to display the load setting menu and the File List dialog box.

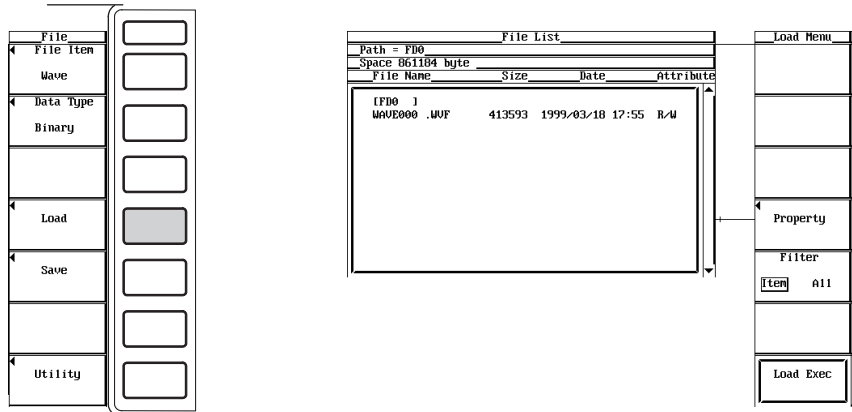

#### Selecting the source medium and directory

6. The procedures are the same as “Selecting the source medium” and “Selecting the source directory” in section 12.5.

#### Selecting the file to be loaded

7. Turn the jog shuttle to select the file.

#### Loading the file

8. Press the [Load Exec] soft key to load the file from the directory indicated in [Path=.....]. The name of the [load Exec] soft key changes to [Abort].

#### Canceling the loading operation

9. Press the [Abort] soft key to cancel the loading operation. The name of the [Abort] soft key changes to [Load Exec].

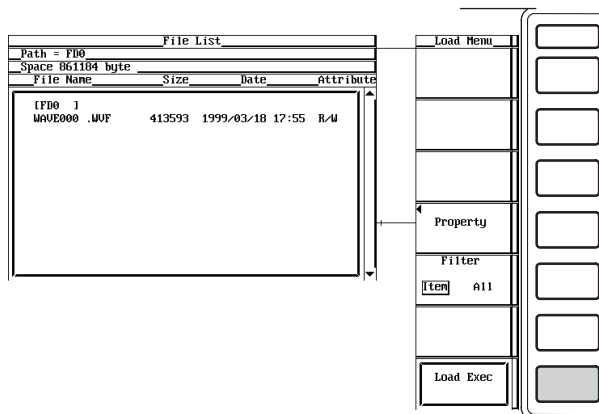

#### Specifying the file to be displayed in the File List dialog box, viewing the properties

The procedures are the same as “Specifying the file to be displayed in the File List dialog box” and “Viewing the properties” in section 12.5.

**Explanation**

**CAUTION**

Never remove the medium (disk) or turn OFF the power while the access indicator or the  mark is blinking. It can damage the medium or destroy the data on the medium.

**Selecting the data type, file extension, data size**

Select the data type from the following list of choices. The file extension is automatically attached to the file name.

- Binary
  - The sampled data in the acquisition memory are saved in binary format.
  - The data that are saved by selecting [Main] in “Selecting the range of the waveform to be saved” (described later) can be loaded to display the waveform and calculate numerical data.
  - A header file is automatically created. The header file is used when analyzing the waveform on a PC. The header file cannot be opened using this instrument. For the header file format, see Appendix 5, “ASCII Header File Format.”
- ASCII
  - The sampled data in the acquisition memory are saved in ASCII format. The data can be used to analyze the waveform on a PC.
  - Data in this format cannot be loaded on this instrument.
- Float
  - The sampled data in the acquisition memory are saved in 32-bit floating point format. The data can be used to analyze the waveform on a PC.
  - Data in this format cannot be loaded on this instrument.

**Data size**

• **For the normal measurement mode**

The following table shows the data size when the waveform data of CH1 to CH8 are saved with a record length of 100 k-words, observation time of 100 ms, and MATH1 and MATH2 turned OFF.

Data Type	Extension	Data Size (Bytes)
Binary	.WVF	Approx. 1.7 M (100 k-words × 8 channels × 2)
	.HDR	Approx. 7 K (approx. 8 K when Math1 and Math2 are ON)
ASCII	.CSV	Approx. 9 M (depends on the input signal conditions) Takes tens of minutes to save the data.
Float	.FLD	Approx. 400 K (100 k × 4)

• **For the harmonic measurement mode**

Same as in the normal measurement mode.

**Waveforms that are saved**

- When the data type is [Binary] or [ASCII], the displayed waveform is saved.
- When the data type is [Float], the selected waveform from CH1 to CH8, MATH1, and MATH2 can be saved.
- The setup parameters of the waveform, such as the vertical axis, the horizontal axis, and the trigger are also saved.
- To reproduce the computation result, [Binary] data of all channels are necessary. Save the data with the display of all channels turned ON.



**Selecting the range of the waveform to be saved**

Select the range (region) of the waveform from the following choices. The only data that can be loaded are those data that are saved by specifying [Binary] in “Selecting the data type, file extension, data size” (described earlier) and [Main] for the range.

- Main  
The range of the Main waveform. It is the range defined by the display record length (range displayed on the screen).
- Z1  
The range of zoom waveform Z1.
- Z2  
The range of zoom waveform Z2.

**Selecting the medium and directory**

See the explanation given in “Selecting the medium and directory” in section 12.5.

**File name and comment**

See the explanation given in “File name and comment” in section 12.5.

**Auto naming function**

See the explanation given in “Auto naming function” in section 12.5.

**Specifying the file to be displayed in the File List dialog box**

You can specify the type of files to display.

- Item  
Displays only the waveform data files (Binary, ASCII, or Float).
- All  
Displays all the files on the medium.

**Properties**

See the explanation given in “Properties” in section 12.5.

**Note**

- You cannot save or load while the data acquisition is in progress (START/STOP indicator is ON).
- If you change the file extension on a PC, for a example, you will not be able to load that file.
- A maximum of 36 characters can be displayed in [Path].
- For file names, upper and lower case letters are not distinguished. For comments, they are distinguished. In addition, the following file names cannot be used due to limitations of MS-DOS.  
AUX, CON, PRN, NUL, CLOCK
- When using the GP-IB or serial interface commands to enter a file name, the following symbols that do not exist on the keyboard of this instrument can be used.  
{ }
- The waveform data loaded from a file overwrites the data in the acquisition memory. Once the memory is overwritten, the old data cannot be recovered. It is recommended that the current waveform data be saved before loading data from a file.
- Even when the data type was set to [Binary], data cannot be loaded if the range of the waveform that was saved was [Z1] or [Z2].
- Waveform data cannot be loaded, if the record length or the module configuration differs from the setting that existed at the time the data were saved. This is also true if the waveform data were saved using an incompatible version of firmware.

# 12.7 Saving Numerical Data

## Keys

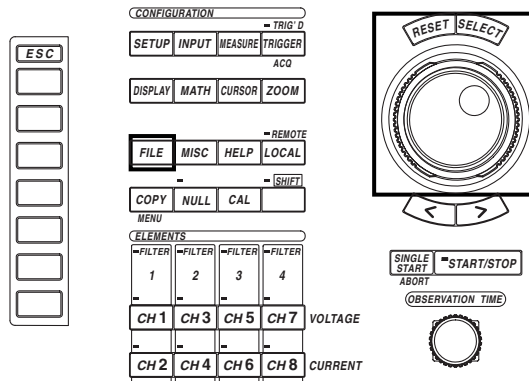

- The  mark indicates the keys that are used for the operation.
- To exit the menu during operation, press the ESC key.

## Procedure

1. Press the FILE key to display the File setting menu.
2. Press the [File Item] soft key to display the File Item setting menu.
3. Press the [Numeric] soft key to select numerical data.

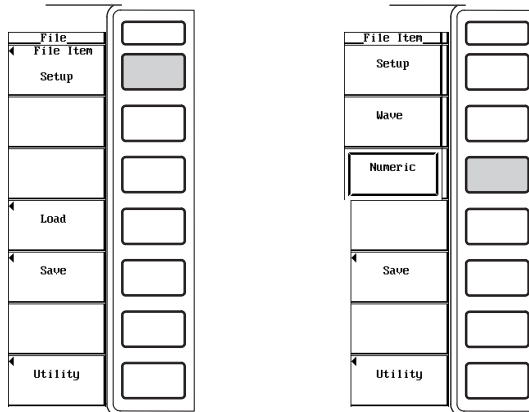

**Selecting the data type**

4. Press the [Data Type] soft key to display the data type selection menu.
5. Press the [ASCII] or [Float] soft key to select the data type.

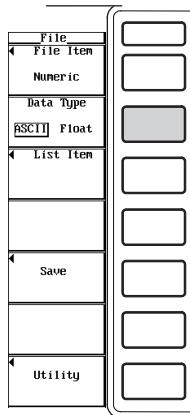

**Selecting the numerical data to be saved**

(The menu appears during the harmonic measurement mode. If the measurement mode is set to normal measurement, go to step 14. For the procedure related to setting the measurement mode, see section 5.1, “Setting the Measurement Mode.”)

6. Press the SETUP key to display the Setup menu. Confirm that [Mode] is set to [Harmonics].
7. Press the FILE key to display the File setting menu.
8. Press the [List Item] soft key to display the numerical data selection dialog box.

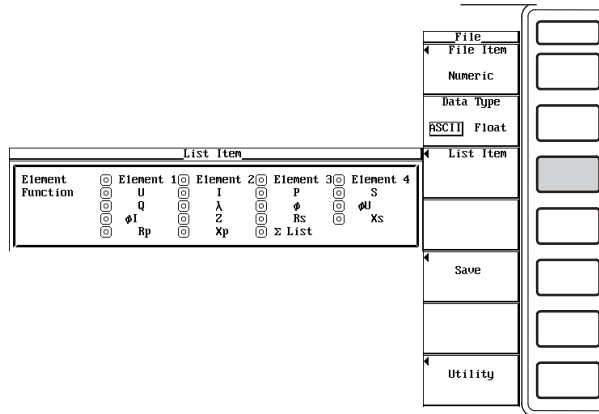

## 12.7 Saving Numerical Data

- **Selecting the element**

- Turn the jog shuttle to select the desired element from [Element1] to [Element4]. [Element4] cannot be selected when the motor module is installed in the element number 4 slot.
- Press the SELECT key. When the button to the left of the element in the numerical data selection dialog box is highlighted, the numerical data of that element will be saved. If the button is not highlighted, the numerical data of that element will not be saved.

- **Selecting the measurement function**

- Turn the jog shuttle to select the desired measurement function that is to be saved from [U] to [ $\Sigma$  List]. [Torque] can also be selected when the motor module is installed in the element number 4 slot.
- Press the SELECT key. When the button to the left of the measurement function in the numerical data selection dialog box is highlighted, the numerical data of that function will be saved. If the button is not highlighted, the numerical data of that measurement function will not be saved.

The numerical data of the measurement function that was highlighted in steps 11 and 12 of the element that was highlighted in steps 9 and 10, are saved.

- Press the ESC key to close the numerical data selection dialog box.

List Item				
Element	<input checked="" type="radio"/> Element 1	<input type="radio"/> Element 2	<input type="radio"/> Element 3	<input type="radio"/> Element 4
Function	<input checked="" type="radio"/> U	<input type="radio"/> I	<input type="radio"/> P	<input type="radio"/> S
	<input type="radio"/> Q	<input type="radio"/> $\lambda$	<input type="radio"/> $\phi$	<input type="radio"/> $\phi$ J
	<input type="radio"/> $\phi$ I	<input type="radio"/> Z	<input type="radio"/> RS	<input type="radio"/> Xs
	<input type="radio"/> Rp	<input type="radio"/> Xp	<input type="radio"/> $\Sigma$ List	

### Displaying the save setting menu

- Press the [Save] soft key to display the save setting menu.

File

File Item

Numeric

Data Type

Float

List Item

Save

Utility

Save Menu

File List

File Name

Save Exec

**Selecting the destination medium and directory**

15. The procedures are the same as “Selecting the destination medium” and “Selecting the destination directory” in section 12.5.

**Setting the file name and comment**

16. The procedures are the same as “Setting the file name and comment” in section 12.5.

**Saving the file**

17. Press the [Save Exec] soft key to save the file to the directory indicated in [Path=.....]. The name of the [Save Exec] soft key changes to [Abort].

**Canceling the saving operation**

18. Press the [Abort] soft key to cancel the saving operation. The name of the [Abort] soft key changes to [Save Exec].

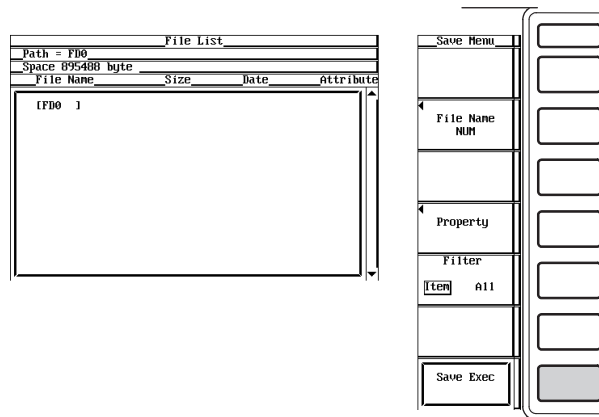
**Specifying the file to be displayed in the File List dialog box, viewing the properties**

- The procedures are the same as “Specifying the file to be displayed in the File List dialog box” and “Viewing the properties” in section 12.5.

**Explanation**

**CAUTION**

Never remove the medium (disk) or turn OFF the power while the access indicator or the  mark is blinking. It can damage the medium or destroy the data on the medium.

**Selecting the data type, file extension, data size**

Select the data type from the following list of choices. The file extension is automatically attached to the file name.

- ASCII
  - The sampled data in the acquisition memory are saved in ASCII format. The data can be used to analyze the waveform on a PC.
  - Data in this format cannot be loaded on this instrument.
- Float
  - The sampled data in the acquisition memory are saved in 32-bit floating point format. The data can be used to analyze the waveform on a PC.
  - Data in this format cannot be loaded on this instrument.

**Data size**

The following table shows the data size when the numerical data of CH1 to CH8 are saved with a record length of 100 k-words, observation time of 100 ms, and MATH1 and MATH2 turned OFF.

• **For the normal measurement mode**

Data Type	Extension	Data Size (Bytes)
ASCII	.CSV	Approx. 6 K (depends on the input signal conditions)
Float	.FLD	Approx. 1 K (43 functions × 6 elements × 4)

• **For the harmonic measurement mode**

Data Type	Extension	Data Size (Bytes)
ASCII	.CSV	Approx. 50 K (when there is one measurement function for each element) (depends on the input signal conditions)
Float	.FLD	<ul style="list-style-type: none"> <li>• When the measurement function is U, I, or P: Approx. 4 K ((502 + 501) × 4)</li> <li>• When the measurement function is other than U, I, or P: Approx. 2K (502 × 4)</li> </ul>

**Numerical data to be saved**

For the meanings of the measurement function symbols, see section 1.2, “Measurement Modes and Measurement/Computation Periods,” 1.7 “Numerical Computation,” appendix 2 “Symbols and Determination of Measurement Functions,” and appendix 3 “Determination of Delta Functions.” For the wiring methods of A and B, see section 5.2, “Selecting the Wiring Method.”

• **For normal measurement mode**

Data of all measurement functions are saved. The numerical data of delta computation and of user-defined functions are also saved.

- **For harmonic measurement mode**
  - The data in the range from Total or dc (0th order) up to 500th order of the selected elements and measurement functions are saved.
    - Select the element from [Element1], [Element2], [Element3], and [Element4].
    - Select the measurement function from U, I, P, S, Q,  $\lambda$ ,  $\phi$ ,  $\phi U$ ,  $\phi I$ , Z, Rs, Xs, Rp, Xp, Torque<sup>2</sup>, and  $\Sigma$  List (all  $\Sigma$ functions).
      - \* This is applicable to products (PZ4000) with firmware version 2.01 or later when the motor module is installed in the element number 4 slot.
  - The numerical data of the measurement functions, fU (or fI), Uthd, lthd, Pthd, Uthf, lthf, Utif, ltif, hvf, and hcf, are saved regardless of the selection made in the previous section.

#### Selecting the medium and directory

See the explanation given in “Selecting the medium and directory” in section 12.5.

#### File name and comment

See the explanation given in “File name and comment” in section 12.5.

#### Auto naming function

See the explanation given in “Auto naming function” in section 12.5.

#### Specifying the file to be displayed in the File List dialog box

You can specify the type of files to display.

- Item  
Displays only the numerical data files.
- All  
Displays all the files on the medium.

#### Properties

See the explanation given in “Properties” in section 12.5.

#### Note

- You cannot save or load while the data acquisition is in progress (START/STOP indicator is ON).
- For the meanings of the measurement function symbols, see section 1.2, “Measurement Modes and Measurement/Computation Periods,” 1.7 “Numerical Computation,” appendix 2 “Symbols and Determination of Measurement Functions,” and appendix 3 “Determination of Delta Functions.”
- For details regarding the wiring methods, A and B, see section 5.2, “Selecting the Wiring Method.”
- In the places where a measurement function is not selected or where there is no numerical data, the following data are saved:
  - For ASCII files: A character string “NAN.”
  - For Float files: 0x7FC00000
- If you change the file extension on a PC, for an example, you will not be able to load that file.
- A maximum of 36 characters can be displayed in [Path].
- For file names, upper and lower case letters are not distinguished. For comments, they are distinguished. In addition, the following file names cannot be used due to limitations of MS-DOS.  
AUX, CON, PRN, NUL, CLOCK
- When using the GP-IB or serial interface commands to enter a file name, the following symbols that do not exist on the keyboard of this instrument can be used.  
{ }

# 12.8 Changing the File Attribute, Deleting Files

## Keys

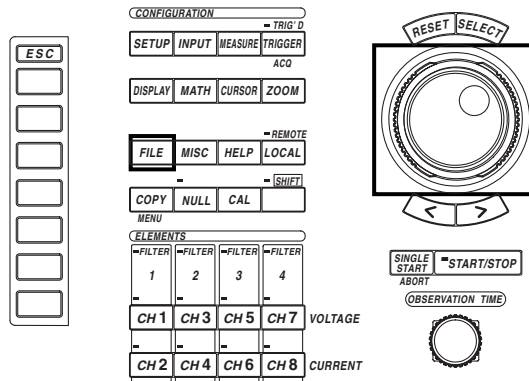

- The  mark indicates the keys that are used for the operation.
- To exit the menu during operation, press the ESC key.

## Procedure

1. Press the FILE key to display the File setting menu.
2. Press the [Utility] soft key to display the Utility setting menu and the File List dialog box.
3. Press the [Function] soft key to display the file function selection menu.
4. Press the [Delete] soft key to display the delete setting menu.

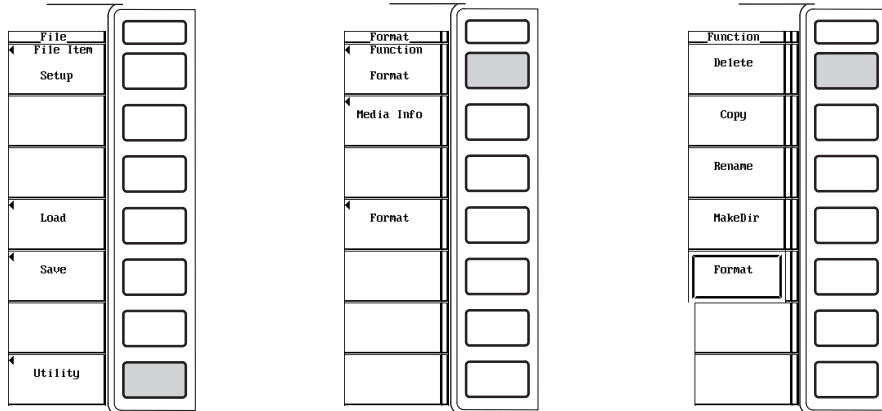



**Selecting the medium and directory**

- The procedures are the same as “Selecting the source medium” and “Selecting the source directory” in section 12.5.

**Changing the file attribute**

- Turn the jog shuttle to select a file
- Press the [Attribute] soft key. The attribute of the selected file changes to [R] or [R/W].

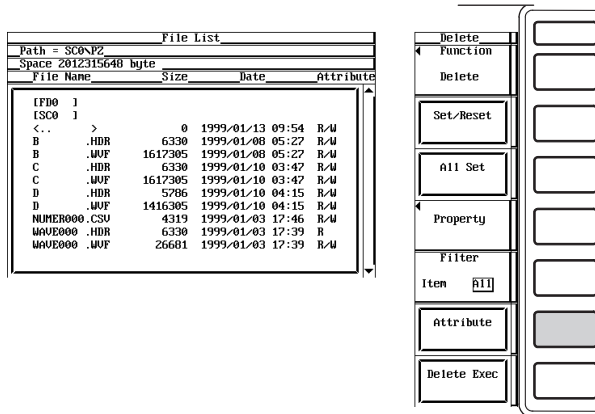

**Selecting the file to be deleted one at a time**

- Turn the jog shuttle to select a file.
- Press the [Set/Reset] soft key. If an [\*] mark is displayed to the left of the file name in the File List dialog box, the file will be deleted. If the [\*] is not displayed, the file will not be deleted.

Go to step 11.

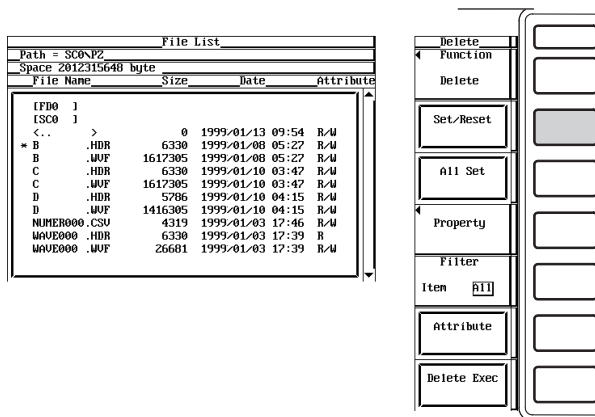

## 12.8 Changing the File Attribute, Deleting Files

### Selecting all files to be deleted

8. Turn the jog shuttle to select a file, directory, or a medium.
9. Press the [All Set] soft key. Depending on whether a file, directory or medium is selected before pressing the [All Set] key, the [\*] marks are either displayed to the left of the directory containing the selected file and all files in that directory, displayed next to the selected directory and all files in that directory, or displayed next to all directories and files on the selected medium (see the Explanation). These directories and files will be deleted. The name of the [All Set] soft key changes to [All Reset].
10. Press the [All Reset] soft key. The previously set [\*] marks are removed. The directories and files will not be deleted. The name of the [All Reset] soft key changes to [All Set].

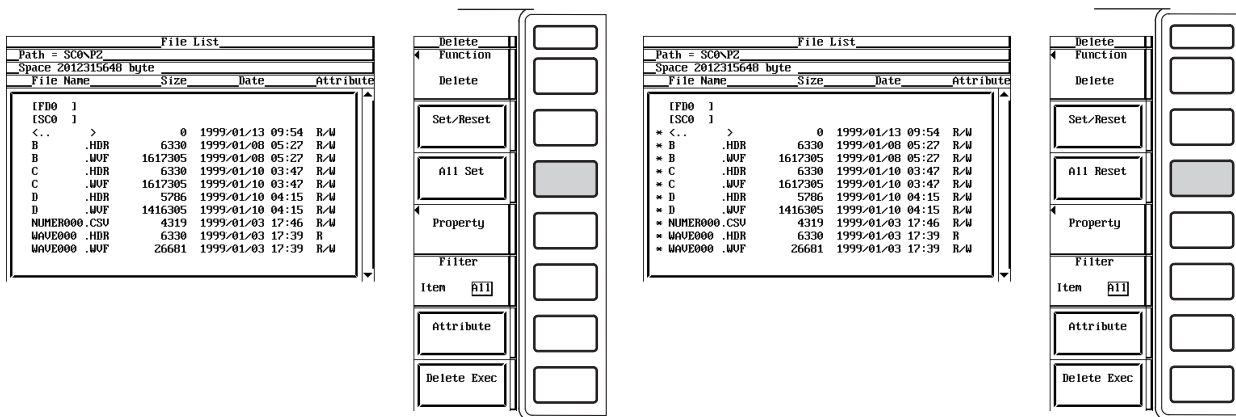

### Deleting the files

11. Press the [Delete Exec] soft key. All files with the [\*] marks are deleted.

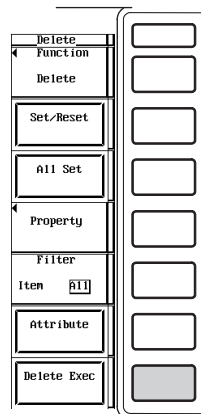

### Specifying the file to be displayed in the File List dialog box, viewing the properties

The procedures are the same as "Specifying the file to be displayed in the File List dialog box" and "Viewing the properties" in section 12.5.

**Explanation****CAUTION**

Never remove the medium (disk) or turn OFF the power while the access indicator or the  mark is blinking. It can damage the medium or destroy the data on the medium.

**Selecting the medium and directory**

See the explanation given in “Selecting the medium and directory” in section 12.5.

**Selecting the file attribute**

Select the attribute for each file from the following choices.

- R/W  
Read and write possible.
- R  
Read only. Cannot write to the file or delete the file.

**Selecting the files to be deleted**

You can delete all files that have a [\*] mark to the left of the file name. There are two methods available to select the files that are to be deleted.

- **Selecting the files one at a time**  
Place [\*] marks to the left of the file names one at a time, using the [Set/Reset] soft key.
- **Selecting all files at once**  
Place [\*] marks to the left of the file names all at once, using the [All Set] soft key. There are three methods to place the marks all at once.
  - Selecting a file and pressing the [All Set] soft key places [\*] marks on the directory containing the selected file and all files in that directory.
  - Selecting a directory and pressing the [All Set] soft key places [\*] marks on the selected directory and all files in that directory.
  - Selecting a medium and pressing the [All Set] soft key places [\*] marks on all the directories and files on the selected medium.

**Specifying the file to be displayed in the File List dialog box**

You can specify the type of files to display.

- Item  
Displays only the data file that was selected in the File Item selection menu and the data type selection menu.
- All  
Displays all the files on the medium.

## 12.8 Changing the File Attribute, Deleting Files

---

### Properties

See the explanation given in “Properties” in section 12.5.

### Note

---

- You cannot delete files while data acquisition is in progress (START/STOP indicator is ON).
  - Deleted data cannot be recovered. Make sure not to erase the wrong files.
  - Directories can be deleted if there are not files in them.
  - If an error occurs while deleting multiple files, the files after the error will not be deleted.
  - Directory attributes cannot be changed.
  - When [File Item] is [Wave], [Data Type] is [Binary], and [Filter] is [Item], deleting a file with a .WVF extension that has a [\*] mark causes the file with the same name with the .HDR extension to be deleted. When [Filter] is [All], only the files that have the [\*] marks are deleted.
-

## 12.9 Copying Files

### Keys

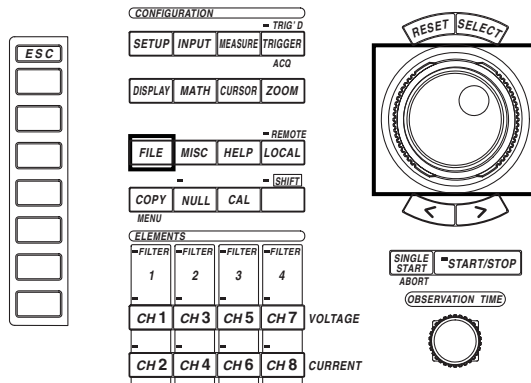

- The  mark indicates the keys that are used for the operation.
- To exit the menu during operation, press the ESC key.

### Procedure

1. Press the FILE key to display the File setting menu.
2. Press the [Utility] soft key to display the Utility setting menu and the File List dialog box.
3. Press the [Function] soft key to display the file function selection menu.
4. Press the [Copy] soft key to display the copy setting menu.

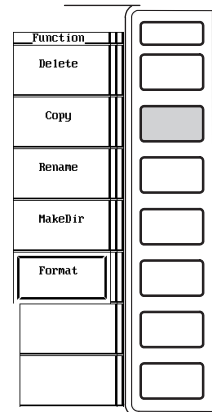
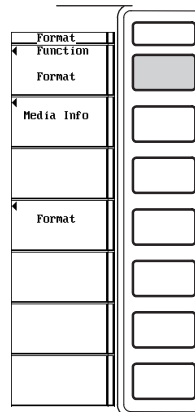
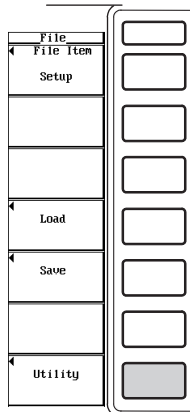

**Selecting the source medium and directory**

- The procedures are the same as “Selecting the source medium” and “Selecting the source directory” in section 12.5.

**Changing the file attribute**

- The procedures are the same as “Changing the file attribute” in section 12.8.

**Selecting the source file one at a time**

- Turn the jog shuttle to select a file.
- Press the [Set/Reset] soft key. If an [\*] mark is displayed to the left of the file name in the File List dialog box, the file will be copied. If the [\*] is not displayed, the file will not be copied.

Go to step 12.

**Selecting all copy source files at once**

- Turn the jog shuttle to select a file, directory, or a medium.
- Press the [All Set] soft key. Depending on whether a file, directory or medium is selected before pressing the [All Set] key, the [\*] marks are either displayed to the left of the directory containing the selected file and all files in that directory, displayed next to the selected directory and all files in that directory, or displayed next to all directories and files on the selected medium (see the Explanation). These directories and files will be copied. The name of the [All Set] soft key changes to [All Reset].
- Press the [All Reset] soft key. The previously set [\*] marks are removed. The directories and files will not be copied. The name of the [All Reset] soft key changes to [All Set].

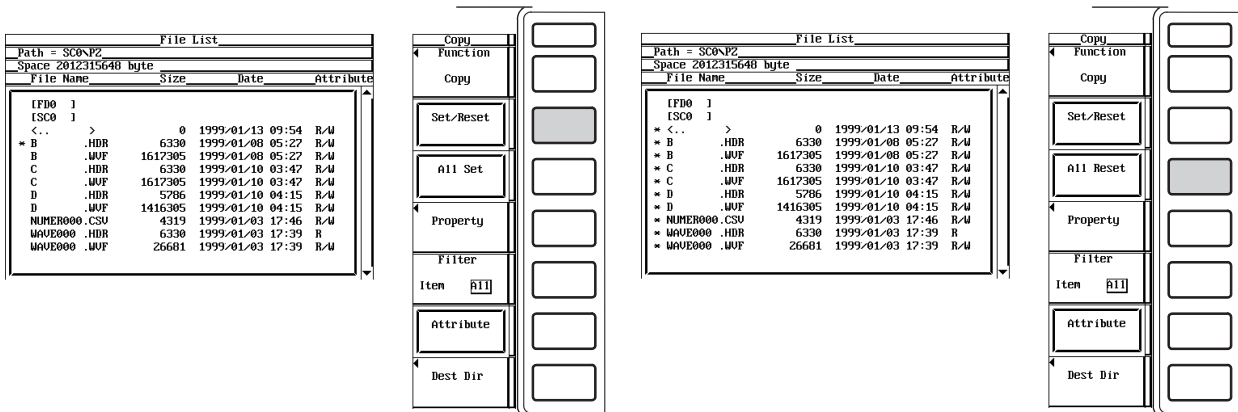

**Selecting the copy destination**

- Press the [Dest Dir] soft key to display the copy execution menu and the copy destination file list dialog box.

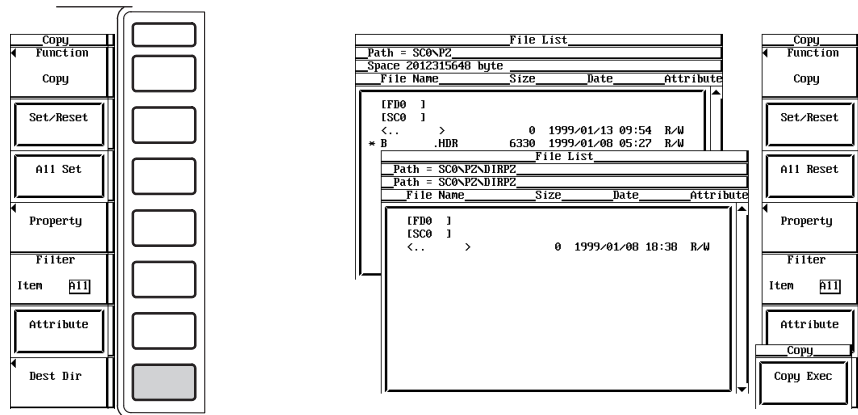

**Selecting the destination medium and directory**

- The procedures are the same as “Selecting the destination medium” and “Selecting the destination directory” in section 12.5.

**Executing the copy operation**

- Press the [Copy Exec] soft key to copy all source files that have [\*] marks.

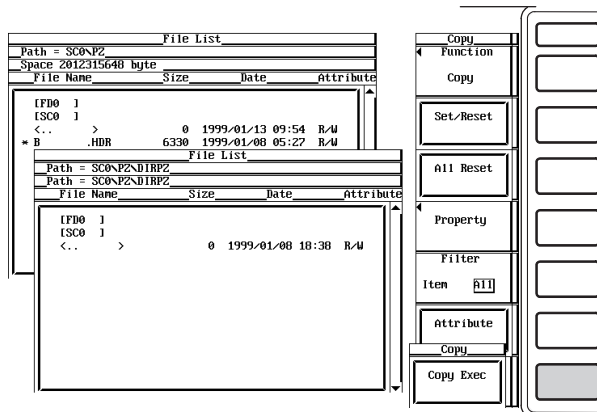

**Specifying the file to be displayed in the File List dialog box, viewing the properties**

- The procedures are the same as “Specifying the file to be displayed in the File List dialog box” and “Viewing the properties” in section 12.5.

### Explanation

---

#### CAUTION

Never remove the medium (disk) or turn OFF the power while the access indicator or the  mark is blinking. It can damage the medium or destroy the data on the medium.

---

#### Selecting the medium and directory of the copy source and copy destination

See the explanation given in “Selecting the medium and directory” in section 12.5.

#### Selecting the file attribute

See the explanation given in “Selecting the file attribute” in section 12.8.

#### Selecting the copy source files

You can copy all files that have a [\*] mark to the left of the file name. There are two methods available to select the files that are to be copied.

- **Selecting the file one at a time**

Place [\*] marks to the left of the file names one at a time, using the [Set/Reset] soft key.

- **Selecting all files at once**

Place [\*] marks to the left of the file names all at once, using the [All Set] soft key. There are three methods to place the marks all at once.

- Selecting a file and pressing the [All Set] soft key places [\*] marks on the directory containing the selected file and all files in that directory.
- Selecting a directory and pressing the [All Set] soft key places [\*] marks on the selected directory and all files in that directory.
- Selecting a medium and pressing the [All Set] soft key places [\*] marks on all the directories and files on the selected medium.

#### Specifying the file to be displayed in the File List dialog box

See the explanation given in “Specifying the file to be displayed in the File List dialog box” in section 12.8.

#### Properties

See the explanation given in “Properties” in section 12.5.

#### Note

---

- You cannot copy files while the data acquisition is in progress (START/STOP indicator is ON).
  - If an error occurs while copying multiple files, the files after the error will not be copied.
  - Directory attributes cannot be changed.
  - If a file with the same name exists at the destination, copying is not allowed.
  - You cannot copy the same files to another directory immediately after copying those files. You must again select the files you wish to copy.
  - When [File Item] is [Wave], [Data Type] is [Binary], and [Filter] is [Item], copying a file with a .WVF extension that has a [\*] mark causes the file with the same name with the .HDR extension to be copied. When [Filter] is [All], only the files that have the [\*] marks are copied.
-



# 12.10 Changing the Directory/File Name, Creating a Directory

## Keys

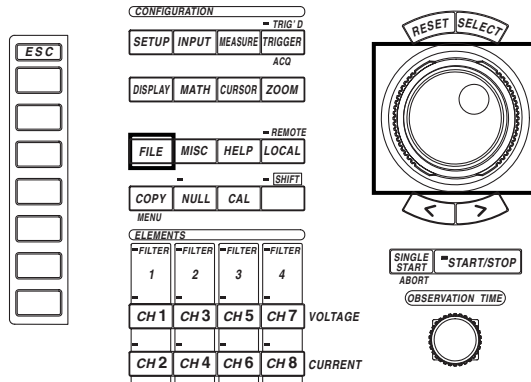

- The  mark indicates the keys that are used for the operation.
- To exit the menu during operation, press the ESC key.

## Procedure

1. Press the FILE key to display the File setting menu.
2. Press the [Utility] soft key to display the Utility setting menu and the File List dialog box.
3. Press the [Function] soft key to display the file function selection menu.

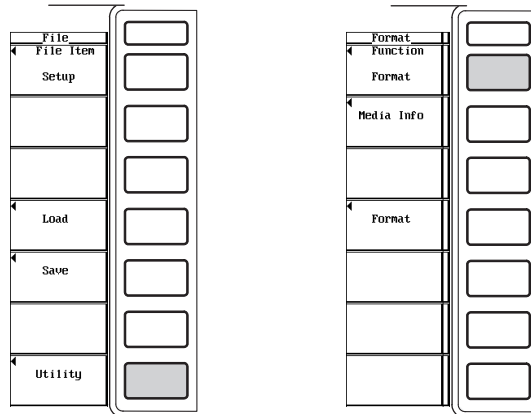

## 12.10 Changing the Directory/File Name, Creating a Directory

### Changing the Directory/File Name

- Press the [Rename] soft key to display the rename menu.

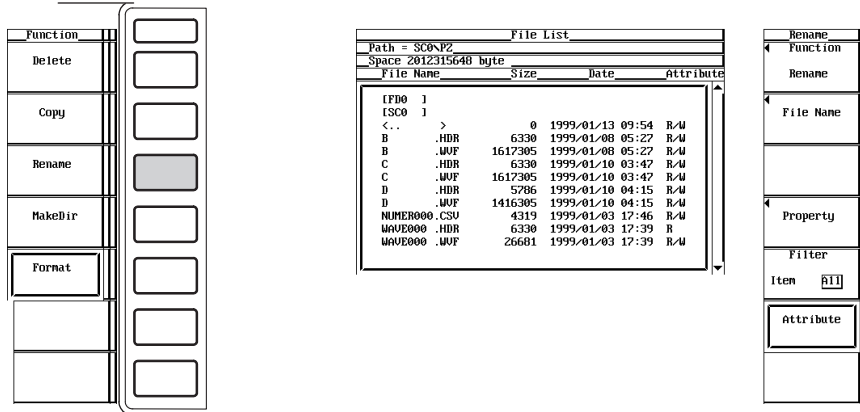

#### Selecting the medium/directory

- The procedures are the same as “Selecting the source medium” and “Selecting the source directory” in section 12.5.

#### Changing the file attribute

- The procedures are the same as “Changing the file attribute” in section 12.8.

#### Changing the directory/file name

- Turn the jog shuttle to select a directory or a file.
- Press the [File Name] soft key. A keyboard appears. The name of the directory/file is displayed in the entry box of the keyboard.
- Use the keyboard to enter the directory/file name.

For keyboard operation, see section 4.1, “Entering Values and Strings.”

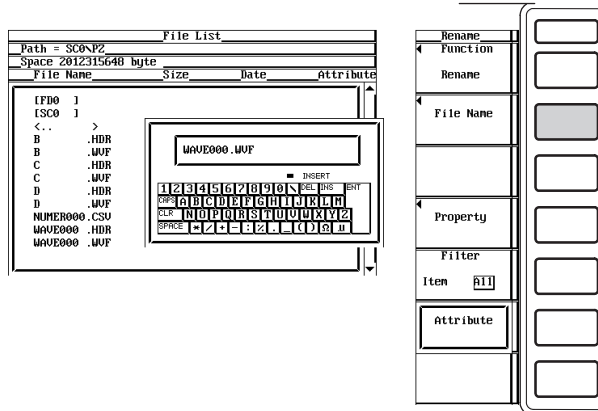

#### Specifying the file to be displayed in the File List dialog box, viewing the properties

- The procedures are the same as “Specifying the file to be displayed in the File List dialog box” and “Viewing the properties” in section 12.5.

Creating a Directory

- Press the [MakeDir] soft key to display the menu for creating a directory.

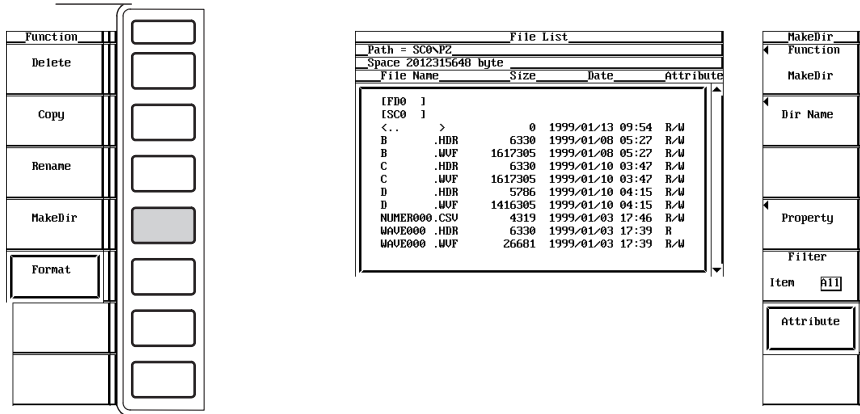

Selecting the medium and directory

- The procedures are the same as “Selecting the source medium” and “Selecting the source directory” in section 12.5.

Changing the file attribute

- The procedures are the same as “Changing the file attribute” in section 12.8.

Creating the directory

- Turn the jog shuttle to select a medium or a directory.
- Press the [Dir Name] soft key. A keyboard appears.
- Use the keyboard to enter a directory name.

For keyboard operation, see section 4.1, “Entering Values and Strings.”

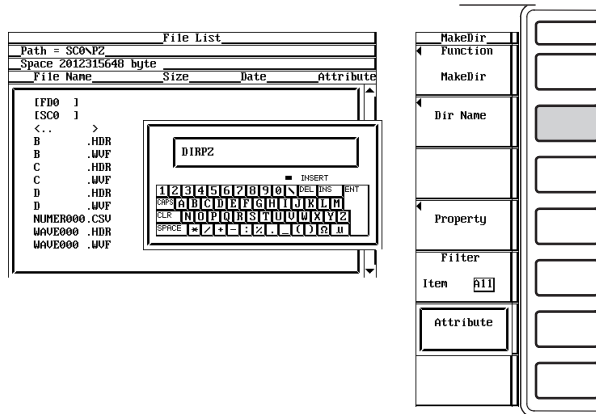

Specifying the file to be displayed in the File List dialog box, viewing the properties

The procedures are the same as “Specifying the file to be displayed in the File List dialog box” and “Viewing the properties” in section 12.5.

### Explanation

---

#### **CAUTION**

Never remove the medium (disk) or turn OFF the power while the access indicator or the  mark is blinking. It can damage the medium or destroy the data on the medium.

---

#### **Selecting the medium and directory**

See the explanation given in “Selecting the medium and directory” in section 12.5.

#### **Selecting the file attribute**

See the explanation given in “Selecting the file attribute” in section 12.8.

#### **Changing the medium/directory/file name**

The assignment of names when changing the medium/directory/file name is the same as the explanation given in “File name/comment” in section 12.5.

#### **Creating a directory**

A new directory can be created on a medium. The assignment of the directory when creating a new directory is the same as the explanation given in “File name/comment” in section 12.5.

#### **Specifying the file to be displayed in the File List dialog box**

See the explanation given in “Specifying the file to be displayed in the File List dialog box” in section 12.8.

#### **Properties**

See the explanation given in “Properties” in section 12.5.

#### **Note**

---

- You cannot rename a directory/file or create a new directory while the data acquisition is in progress (START/STOP indicator is ON).
  - Directory attributes cannot be changed.
  - If a file with the same name exists in the same directory, renaming is not allowed.
  - If a directory with the same name exists in the same directory, the directory cannot be created.
  - When [File Item] is [Wave], [Data Type] is [Binary], and [Filter] is [Item], renaming the name of the selected file with a .WVF extension causes the file with the same name with the .HDR extension to be changed. When [Filter] is [All], only the selected files are changed.
-

## 13.1 Installing the Paper Roll into the Built-in Printer (Option), Paper Feeding

### Paper Roll for Printing

The printer uses a dedicated roll of paper provided by YOKOGAWA. Do not use any other type of paper roll. When using the printer for the first time, use the roll of paper that is included in the package. Order extra rolls from your nearest YOKOGAWA dealer as listed on the back cover of this manual.

Part No.	: B9850NX
Specifications	: Thermal-sensitive paper, 30 m
Sold in Packs of	: 5 rolls

### Handling the Roll of Paper

The paper is a thermal-sensitive paper that changes color with the application of heat. Take note of the following points.

#### Storage precautions

The paper starts changing color at around 70°C. It is affected by heat, humidity, light, and chemicals regardless of whether the paper has been used or not. Note the following points.

- Store the paper in a cool, dry, and dark place.
- After opening the package, use it quickly.
- If the paper is left in contact for long periods of time with plastic film (such as a vinyl chloride film or Scotch tape) containing plasticizers, the paper will lose some of its ability to reproduce color. As a result, for example, if you are going to store the paper in a folder, use a folder made of polypropylene.
- When using glue on the paper, do not use a glue containing organic solvents such as alcohol or ether, as they will change the color of the paper.
- For prolonged storage, we suggest you copy the roll chart. Due to the characteristics of the thermal-sensitive paper, the recording section may lose color over time.

#### Precautions on use

- Use only rolls of paper provided by YOKOGAWA.
- Touching the paper with sweaty hands can leave finger print marks or blur the printing.
- Rubbing the surface with a hard object can cause the paper to change color due to the heat caused by friction.
- If chemicals, oil, or other liquids come in contact with the paper, the paper may change color or the printing may fade.

### Installing the Paper Roll

1. Open the printer cover by pulling up on the handle on the left side of the printer while pressing the lock release lever towards the arrow indicated by "OPEN."

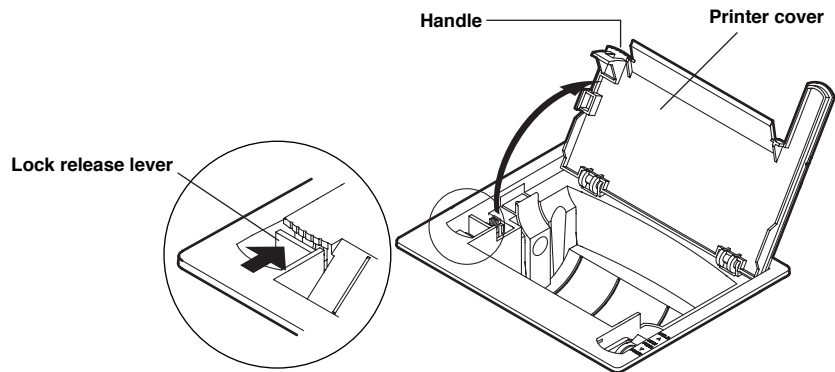

2. Move the release arm located near the right front to the "MAN FEED" position. Hold the roll of paper so that the inside of the paper (not the glossy side) is facing up. While pressing the movable holder on the left side of the roll storage space to the left, set the core in the right holder. Then, release the movable holder.

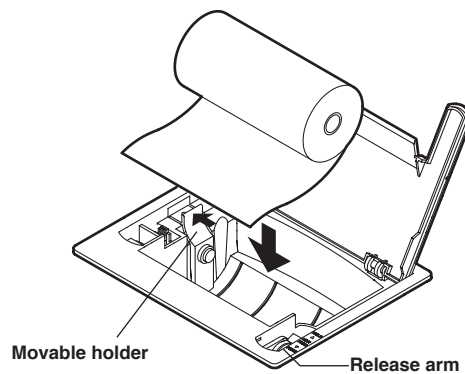

3. Insert the tip of the roll chart evenly in the space between the roller and the black guide and turn the feed knob away from you until 10 cm of the roll chart is showing at the top of the roller.

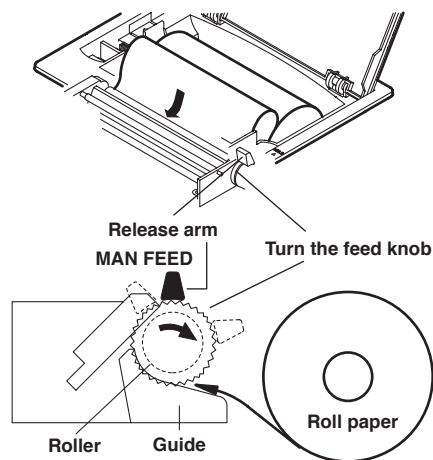

---

### 13.1 Installing the Paper Roll into the Built-in Printer (Option), Paper Feeding

4. Move the release arm to the "Free" position and straighten the roll chart. Then, move the release arm to the "HOLD" position. If the release arm is not in the "HOLD" position, an error message will be displayed at the time of printing. In this case, you will not be able to print.

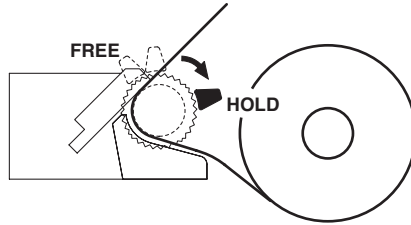

5. Move the printer cover from the back to the front and close the cover. Make sure that the tip of the roll sheet is showing from the opening in the printer cover. When closing the printer cover, press the cover firmly until it clicks.

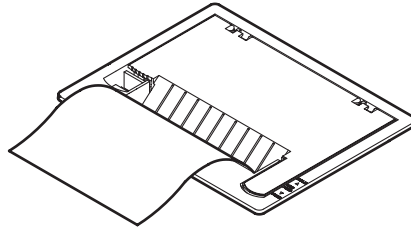

---

**Note**

After the paper roll is installed, follow the steps on the next page to check that the paper is feeding properly. If it is not feeding evenly, continue to feed the paper for another 30 cm. The paper will straighten out.

---

## 13.1 Installing the Paper Roll into the Built-in Printer (Option), Paper Feeding

### Paper Feeding

#### Keys

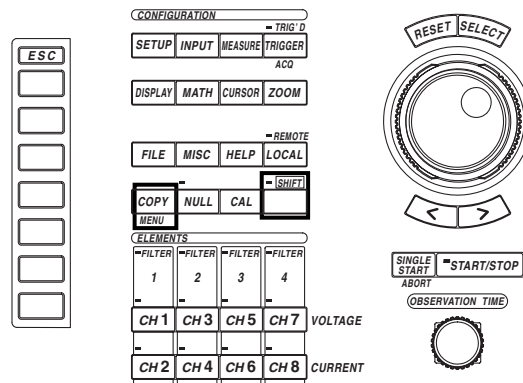

- The  mark indicates the keys that are used for the operation.
- To exit the menu during operation, press the ESC key.

#### Procedure

1. Press the SHIFT+COPY(MENU) to display the Copy setting menu.
2. Press the [Copy to] soft key to display the output medium selection menu.
3. Press the [Printer] soft key.
4. Press the [Paper Feed] soft key. The paper is fed while the [Paper Feed] soft key is being pressed.

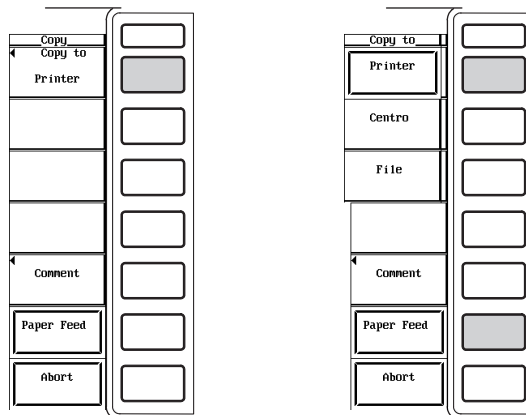

#### Explanation

You can feed the chart when checking to see whether the roll of paper is properly installed or when you want to skip over a dirty section.

#### Note

You cannot feed the paper while the data acquisition is in progress (START/STOP indicator is ON).



## 13.2 Printing to the Built-in Printer (Option)

### Keys

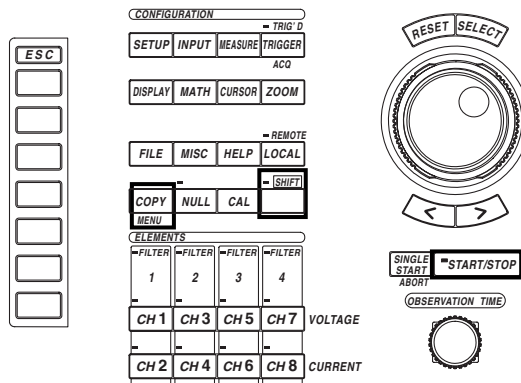

- The  mark indicates the keys that are used for the operation.
- To exit the menu during operation, press the ESC key.

### Procedure

1. Press the SHIFT+COPY(MENU) to display the Copy setting menu.
2. Press the [Copy to] soft key to display the output medium selection menu.
3. Press the [Printer] soft key.

#### Outputting screen image data

- **Setting comment**
4. Press the [Comment] soft key. A keyboard appears.
  5. Use the keyboard to enter a comment.

For keyboard operation, see section 4.1, "Entering Values and Strings."

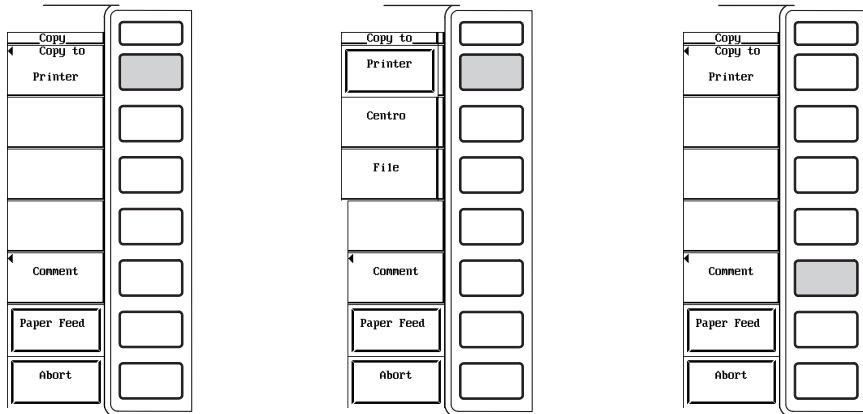

## 13.2 Printing to the Built-in Printer (Option)

---

- **Printing**

6. Display the screen that you wish to print.
7. Press the START/STOP key to stop the data acquisition.  
Check that the START/STOP indicator is OFF.
8. Press the COPY key to print the screen image.

- **Canceling the printing operation**

9. Press the [Abort] soft key in the Copy setting menu.

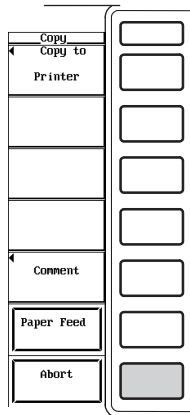

### Outputting numerical data lists (applicable to products (PZ4000) with firmware version 2.01 or later)

- **Outputting the list**

4. Press the START/STOP key to stop the data acquisition.  
Check that the indicator above the START/STOP key is turned OFF.
5. Press the [Print Data List Exec] soft key to output the numerical data list.

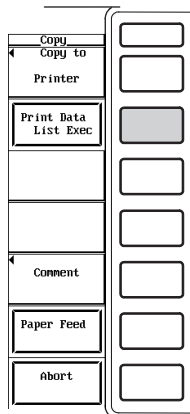

- **Canceling the output operation**

6. Press the [Abort] soft key in the Copy setting menu.

**Explanation****Outputting screen image data****Setting comment**

The comments appear at the bottom of the screen. The comments are also output as screen image data.

**Number and types of characters that can be used**

Item	Number of characters	Characters that can be used
Comment	0 to 25 characters	All characters (including spaces)

**Outputting numerical data list**

Outputs the numerical data according to the specified number of displayed digits (see section 8.1). This is applicable to products (PZ4000) with firmware version 2.01 or later.

- **Data list of normal measurement**

- Output when the measurement mode is normal.
- Elements are listed horizontally and measurement functions are listed vertically.
- When the number of displayed digits is 6, the elements are printed using two columns. Accordingly, the measurement function list is also printed using two columns.

- **Data list of harmonic measurement**

- Output when the measurement mode is harmonic.
- Elements and measurement functions of the [Dual List] specified in section 8.5 are listed horizontally and the harmonic order is listed vertically.
- The range of harmonic order is the range specified by [Min Order] and [Max Order] in section 10.7.

- **Header**

Outputs the observation time (----- is printed during the harmonic measurement mode), sampling rate, date, time, and the measurement range of each element.

**Note**

You cannot print while the data acquisition is in progress (START/STOP indicator is ON).

# 13.3 Printing to an External Centronics Printer

## Keys

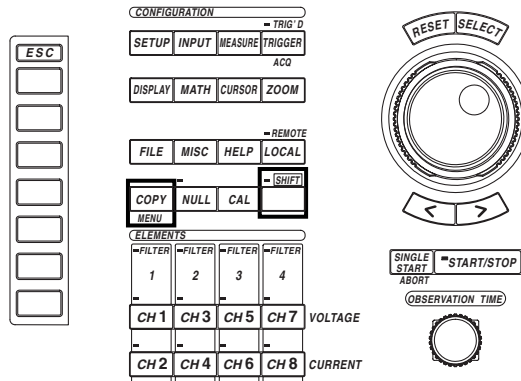

- The  mark indicates the keys that are used for the operation.
- To exit the menu during operation, press the ESC key.

## Procedure

1. Press the SHIFT+COPY(MENU) to display the Copy setting menu.
2. Press the [Copy to] soft key to display the output medium selection menu.
3. Press the [Centro] soft key.

### Selecting output command type

4. Press the [Format] soft key to display the output command selection menu.
5. Press one of the keys from [ESC-P] to [PR201] to select the output command type.  
 If you select [ESC-P], [ESC-P2], [BJ], or [PCL5], go to step 6.  
 If you select [LIPS3] or [PR201], go to step 7.

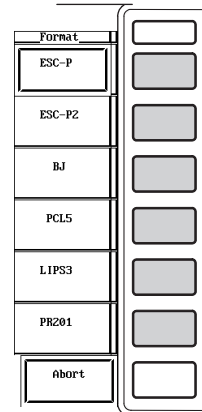
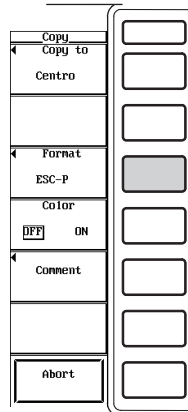
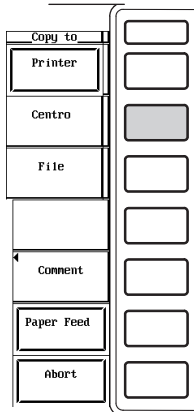
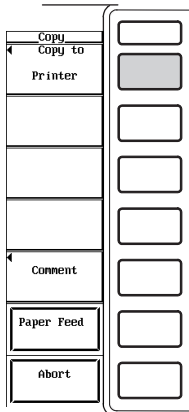

**Select whether or not to print in color (ON/OFF)**

(This step applies if you selected [ESC-P], [ESC-P2], [BJ], or [PCL5] in step 5.)

6. Press the [Color] soft key to select [ON] or [OFF].

**Setting comment**

7. Press the [Comment] soft key. A keyboard appears.
8. Use the keyboard to enter a comment.

For keyboard operation, see section 4.1, "Entering Values and Strings."

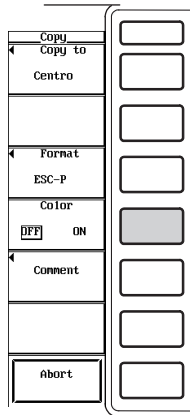

**Printing**

9. Display the screen that you wish to print.
10. Press the START/STOP key to stop the data acquisition.  
Check that the START/STOP indicator is OFF.
11. Press the COPY key to print the screen image.

**Canceling the printing operation**

12. Press the [Abort] soft key in the Copy setting menu.

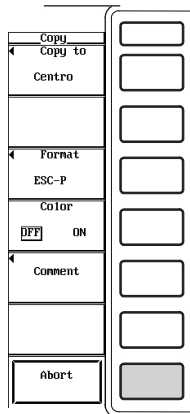

### 13.3 Printing to an External Centronics Printer

#### Explanation



You can send the screen image data to an external printer via the Centronics interface.

#### CAUTION

Use a 25-pin D-Sub cable for connecting the external printer and this instrument. If the cable is not connected properly, damage to this instrument and to other connected devices may result.

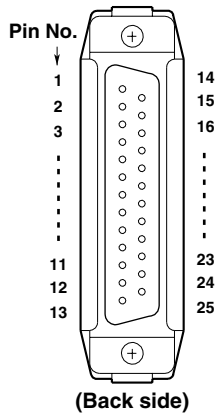

#### Centronics interface specifications

Pin No.	Signal	Pin No.	Signal
1	STROBE	10	ACK (acknowledge)
2	DATA0 (Print data bit 0)	11	BUSY
3	DATA1 (Print data bit 1)	12	PE (Paper end)
4	DATA2 (Print data bit 2)	13	SLCT (select)
5	DATA3 (Print data bit 3)	14	AFDXT (auto feed transfer)
6	DATA4 (Print data bit 4)	15	Error (Printer error)
7	DATA5 (Print data bit 5)	16	INIT (initializing of printer)
8	DATA6 (Print data bit 6)	17	SLCTIN (select in)
9	DATA7 (Print data bit 7)	18 to 25	GND

#### Selecting the output command type

Select the output command type for the external printer from the following list of choices.

- ESC-P
- ESC-P2 (for printers that support ESC/P raster commands)
- BJ
- PCL5
- LIPS3
- PR201 (PC-PR201)

#### Turning ON/OFF the color output

When the output command type is [ESC-P], [ESC-P2], [BJ], or [PCL5], select whether or not to print in color.

- OFF  
Prints the waveforms in black and white.
- ON  
Prints the waveforms in color (256 colors).

#### Setting comment

See the explanation given in "Setting Comment" in section 13.2.

#### Note

You cannot print while the data acquisition is in progress (START/STOP indicator is ON).

# 13.4 Saving Screen Images to Floppy Disk and SCSI Device

## Keys

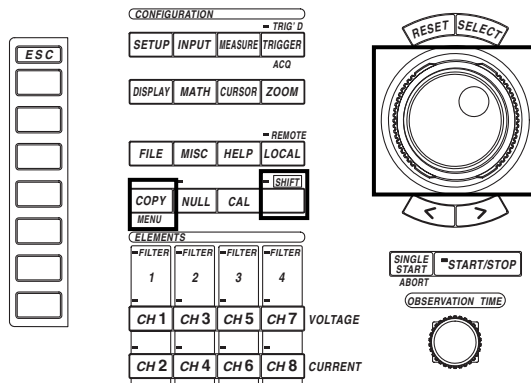

- The  mark indicates the keys that are used for the operation.
- To exit the menu during operation, press the ESC key.

## Procedure

1. Press the SHIFT+COPY(MENU) to display the Copy setting menu.
2. Press the [Copy to] soft key to display the output medium selection menu.
3. Press the [File] soft key.

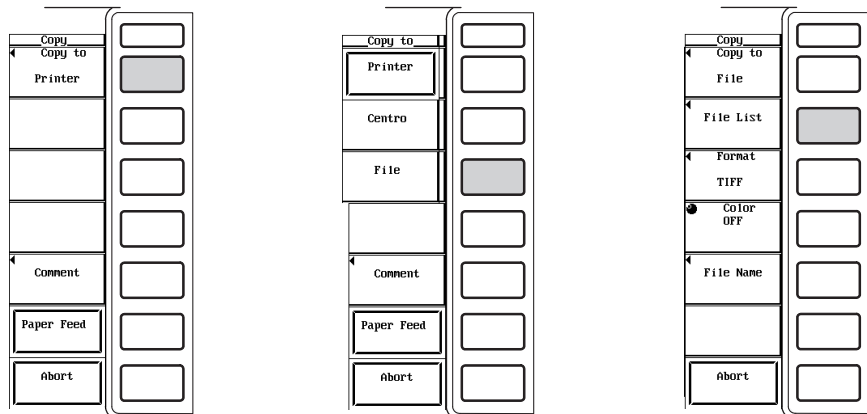

### Selecting the destination medium and directory

4. Press the [File List] soft key to display the File List dialog box.
5. The procedures are the same as "Selecting the source medium" and "Selecting the source directory" in section 12.5.
6. Press the ESC key to close the File List dialog box.

File List				
Path = F00				
Path = F00				
File Name	Size	Date	Attribute	
[F00 ]				
Ta_000 .TIF	38574	1999/03/02 16:31	R/W	

## 13.4 Saving Screen Images to Floppy Disk and SCSI Device

### Selecting the data format

7. Press the [Format] soft key to display the data format selection menu.
8. Press one of the keys from [TIFF] to [Post Script] to select the data format.  
If you select [TIFF] or [BMP], go to step 9.  
If you select [Post Script], go to step 11.

### Selecting color output

(This step applies if [TIFF] or [BMP] was selected in step 8.)

9. Turn the jog shuttle to select from [Color] to [OFF].  
If you select [Color] or [Reverse], go to step 10.  
If you select [OFF], go to step 11.

### Select whether or not to compress the data (ON/OFF)

(This step applies if [Color] was selected in step 9.)

10. Press the [Compression] soft key to select [ON] or [OFF].

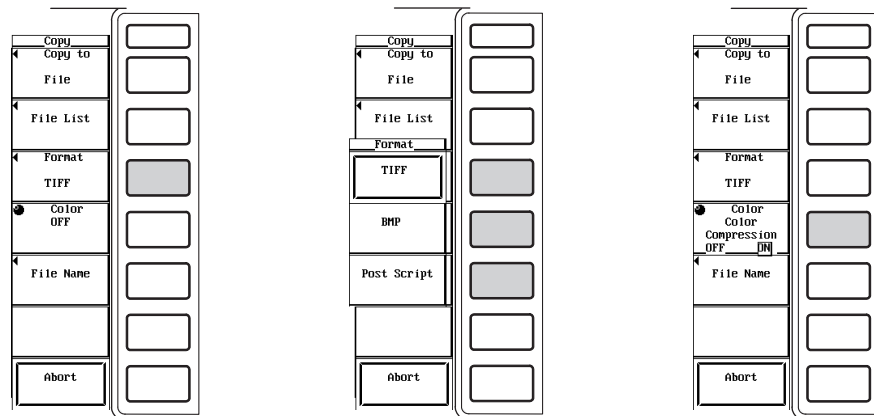

### Setting the file name and comment

11. The procedures are the same as "Setting the file name and comment" in section 12.5.

### Printing

12. Display the screen that you wish to save.
13. Press the START/STOP key to stop the data acquisition.  
Check that the START/STOP indicator is OFF.
14. Press the COPY key to save the screen image.

### Canceling the save operation

15. Press the [Abort] soft key in the Copy setting menu.

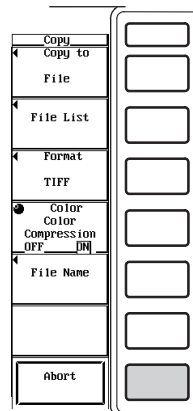



**Explanation**

The screen image can be saved to a floppy disk or to a SCSI device.

**Selecting the destination medium and directory.**

See the explanation given in “Selecting the medium and directory” in section 12.5.

**Selecting the data format, file extension, and data size**

Select the data format from the following list of choices. The file extension is automatically attached to the file name.

Data Type	Extension	Data Size (Bytes)
TIFF	.TIF	Approx. 350 K (Color, data compression OFF)
BMP	.BMP	Approx. 50 K (Color, data compression ON)
PostScript	.PS	Approx. 80 K

\* These are reference values. For PostScript, there are no color and data compression selections.

**Selecting color output**

When the data format is [TIFF] or [BMP], select from the following list of choices

- Color  
Saves the screen image data in color (256 colors).
- Reverse  
Saves the screen image in color with the background and text set to white and black, respectively.
- OFF  
Saves the screen image data in black and white.

**Turning ON/OFF the data compression**

When the data format is [TIFF] or [BMP], select from the following list of choices.

- OFF  
Saves without compressing the data.
- ON  
Saves by compressing the data using LZW and RLE for TIFF and BMP formats, respectively.

**File name and comment**

See the explanation given in “File name and comment” in section 12.5.

**Auto naming function**

See the explanation given in “Auto naming function” in section 12.5.

**Note**

You cannot save while the data acquisition is in progress (START/STOP indicator is ON).

# 14.1 External Trigger Output



## CAUTION

Do not apply an external voltage to the external trigger output connector. It may damage the instrument.

### Trigger output terminal

A CMOS level signal is output when a trigger occurs. The level is normally high, but goes low when a trigger occurs.



### Specifications

Item	Specification
Connector type	BNC connector
Output level	CMOS
Output logic	⌋ (negative logic)
Output delay time	within (1 μs+1 sampling period)
Output hold time	200 ns or more at low level

### Output Circuit Diagram/Timing Chart

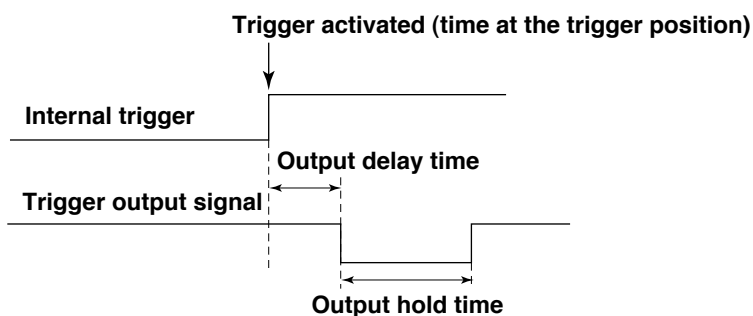
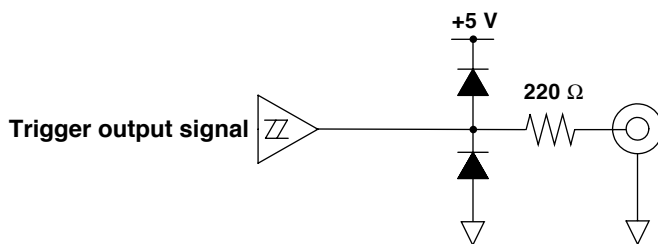

**Note**

For the handling of the external trigger input, see section 7.2, “Selecting the Trigger Source.”

## 14.2 Selecting the Message Language/Setting the Brightness of the Screen

### Keys

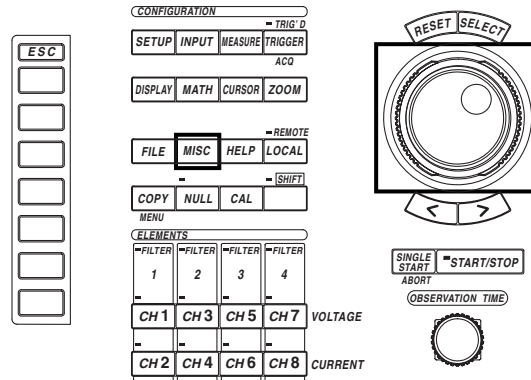

- The  mark indicates the keys that are used for the operation.
- To exit the menu during operation, press the ESC key.

### Procedure

1. Press the MISC key to display the Misc menu.
2. Press the [Config] soft key to display the configuration menu.

#### Selecting the message language

3. Press the [Message] soft key to display the message language selection menu.
4. Press [ENG] or [JPN] to select the language.

#### Setting the brightness of the screen

3. Turn the jog shuttle to select the [LCD Brightness] value from [-1] to [3].

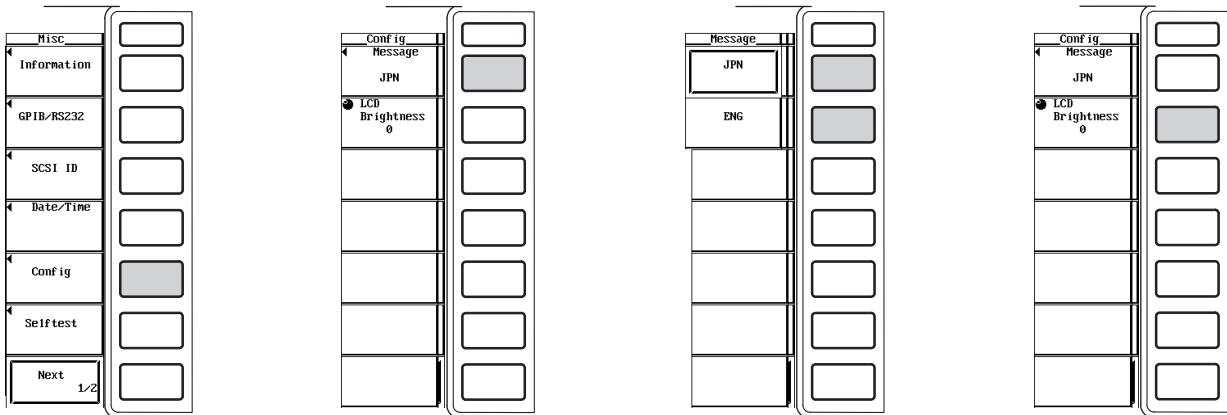

### Explanation

#### Selecting the message language

An error message is displayed when an error occurs. Select the language to use to display the message from the following choices. The error codes for the error messages are the same. For details on the error messages, see section 16.2.

- ENG  
Displays the messages in English.
- JPN  
Displays the messages in Japanese.

#### Setting the brightness of the screen

Set the brightness of the screen between -1 and 3. The darkest setting is [-1] and the brightest is [3].

# 14.3 Setting the Display Colors of the Screen

## Keys

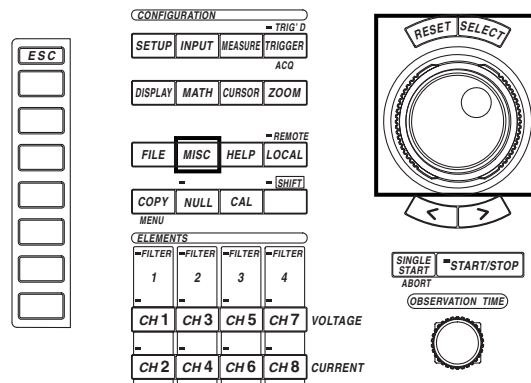

- The  mark indicates the keys that are used for the operation.
- To exit the menu during operation, press the ESC key.

## Procedure

1. Press the MISC key to display the Misc menu.
2. Press the [Next 1/2] soft key to display the [Next 2/2] menu.

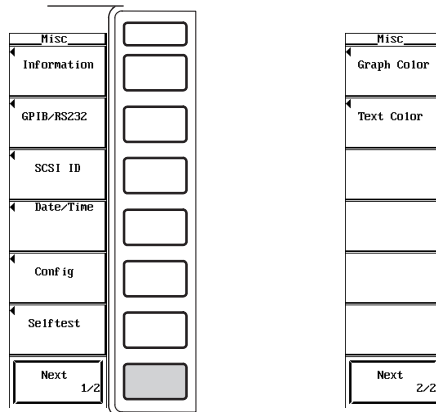

**Setting the color of graphical items**

- **Selecting default or user**

3. Press the [Graph Color] soft key to display the graphics color setting menu.
4. Turn the jog shuttle to set the [Mode] to [Default] or [User].

- **Setting user colors**

5. Press the [User Color] soft key to display the graphics color setting dialog box.
6. Turn the jog shuttle to select the item you wish to set.
7. Press the SELECT key. The color level setting box appears.
8. Turn the jog shuttle to select the color level from [0] to [7].
9. Press the SELECT key or the ESC key to close the setting box.

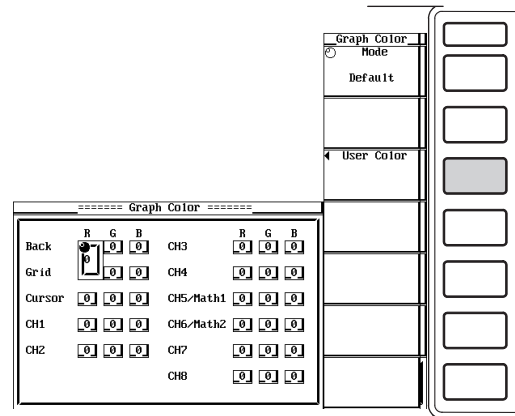
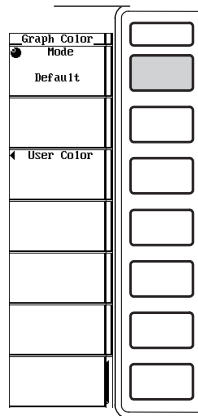
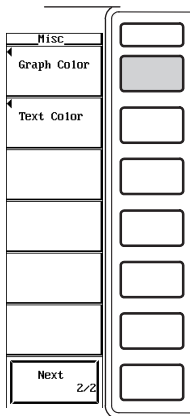

## 14.3 Setting the Display Colors of the Screen

### Setting the text color

- **Selecting preset or user**
  3. Press the [Text Color] soft key to display the text color setting menu.
  4. Turn the jog shuttle to select the [Mode] from [Preset1] to [User].
- **Setting user colors**
  5. Press the [User Color] soft key to display the text color setting dialog box.
  6. Turn the jog shuttle to select the item you wish to set.
  7. Press the SELECT key. The color level setting box appears.
  8. Turn the jog shuttle to select the color level from [0] to [7].
  9. Press the SELECT key or the ESC key to close the setting box.

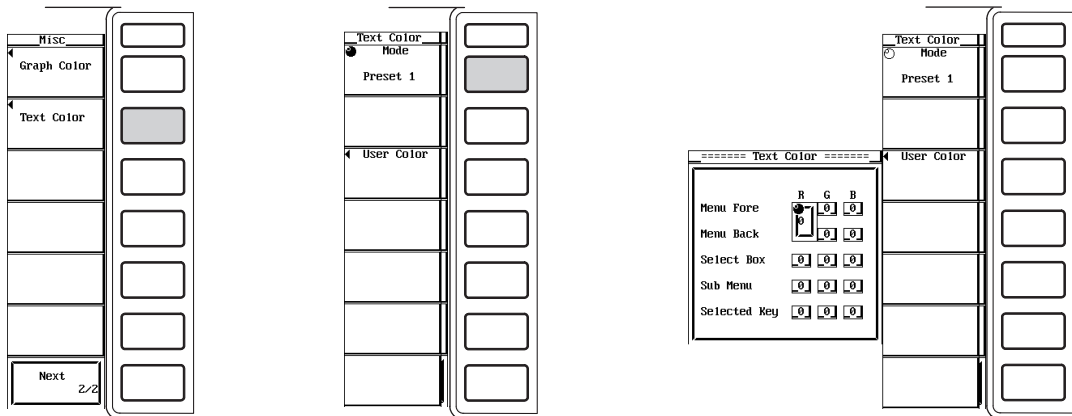

### Explanation

You can set the display color for different items on the screen. The color is set using ratios (0 to 7) of red (R), green (G), and blue (B).

### Setting the graphics color

Select either the default or user setting.

For the user setting, the display color can be set on the following items.

- Back  
Sets the background color within the waveform display frame.
- Grid  
Sets the color of the menu frame.
- Cursor  
Sets the color of the marker and cursor.
- CH1 to CH8  
Sets the colors of the waveform. The colors for Math1 and Math2 are set to the same colors as CH5 and CH6, respectively.

### Setting the text color

Select the text color from presets 1 to 3 or the user setting.

For the user setting, the display color can be set on the following items.

- **Menu Fore**  
Sets the color of the menu, dialog box, window, and other text that is displayed on the screen.
- **Menu Back**  
Sets the color of the waveform display frame and the background color for the text on the screen.
- **Select Box**  
Sets the background color inside the selected menu frame or box.
- **Sub Menu**  
Sets the color of the selected dialog box and window.
- **Selected Key**  
Sets the color of the selected soft key.



# 14.4 Setting the Action-on-Trigger

## Keys

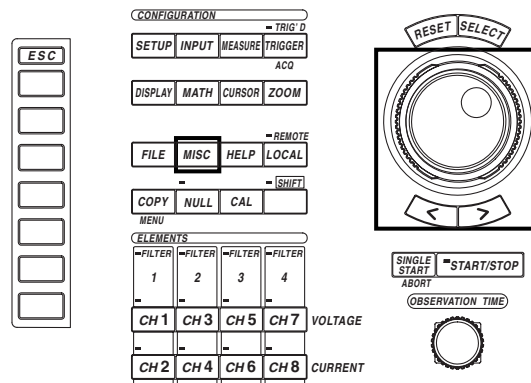

- The  mark indicates the keys that are used for the operation.
- To exit the menu during operation, press the ESC key.

## Procedure

1. Press the MISC key to display the Misc menu.
2. Press the [Next 1/2] soft key to display the [Next 2/2] menu.
  - \* Action-on-trigger is applicable to products (PZ4000) with firmware version 2.01 or later.)

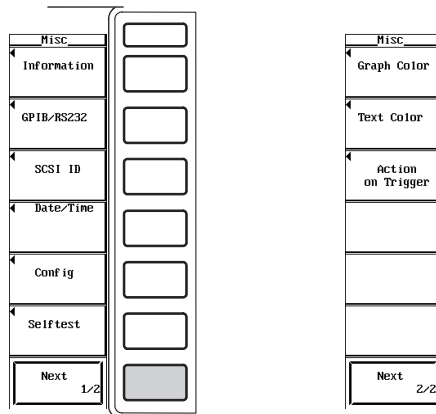

**Turning ON/OFF the action used to save the numerical data, waveform data, and setup parameters**

3. Press the [Save to File] soft key to select [ON] or [OFF].

**Turning ON/OFF the action used to output (or save) the screen image data**

4. Press the [Hard Copy] soft key to select [ON] or [OFF].

**Setting the number of times to perform the action**

5. Turn the jog shuttle to set the action count.

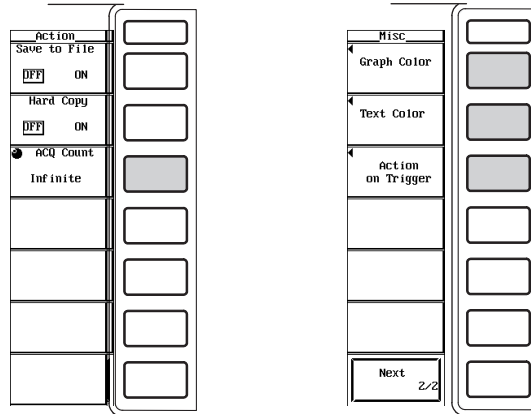

**Executing/Stopping action-on-trigger**

Press the START/STOP key to execute action-on-trigger. Action-on-trigger stops when the START/STOP key is pressed again to stop the data acquisition or after performing the action the specified number of times. When the SINGLE START key is pressed, the action-on-trigger is carried out once.

### Explanation

You can have a specified action to be carried out when a trigger occurs.

#### **Saving the numerical data, waveform data, and setup parameters**

You can select whether or not to save the data specified in chapter 12 (numerical data, waveform data, or setup parameters) when a trigger occurs. The save destination is the medium specified in chapter 12.

- ON: Saves the data.
- OFF: Does not save the data.

#### **Outputting or saving screen image data**

You can select whether or not to output (or save) the screen image data when a trigger occurs. The output (save) destination is the destination specified in chapter 13.

- ON: Outputs (or saves) the data.
- ON: Does not output (or save) the data.

#### **Action count**

- 1 to 65536  
Action-on-trigger terminates after performing the action the specified number of times.
- Infinite  
The action is repeated until the data acquisition is stopped with the START/STOP key.
- The action count cannot be changed while action-on-trigger is in progress.

#### **Executing/Stopping action-on-trigger**

- Executing action-on-trigger  
Action-on-trigger is executed when waveform acquisition is started with the START/STOP or SINGLE START key. When the SINGLE START key is pressed, the action-on-trigger is carried out once.
- Stopping action-on-trigger  
Press the START/STOP key to stop the data acquisition.

#### **Name of the file for saving data**

- Files are automatically named with three digit numbers from 000 to 999. You can specify a common name (up to five characters) that is placed before the three digit number. The common name (up to five characters) is the file name that is specified during the save operation of various data (see chapters 12 and 13).
- If a file with the same name exists at the destination, an error message is displayed and the file is not saved.

#### **Note**

---

The number of files that can be saved varies depending on the data size of the file and the free space at the save destination.

---

## 15.1 Inputting Signals of rotating speed and Torque

Signals from revolution sensors and torque meters can be input to channels 7 and 8 of the PZ4000. For revolution sensors, the signal is the DC voltage (analog signal) or the pulse count that are proportional to the rotating speed of the motor. For torque meters, it is the DC voltage (analog signal) that is proportional to the torque of the motor. By using the active power and frequency that are measured using the power measurement module and the rotating speed and torque data input through the motor module, the PZ4000 can compute parameters such as motor output, synchronous speed, slip, motor efficiency, and total efficiency.

### CAUTION

When the PZ4000 is ON, do not apply a voltage that exceeds the maximum allowable input of 50 Vpk or 25 Vrms to the sensor input connector. When the PZ4000 is OFF, turn off the power supplied to the sensor input connector.

### Revolution Sensor Signal Input Channel (CH7)

Input the signal output from the revolution sensor (a DC voltage (analog signal) or a pulse signal that is proportional to the rotating speed of the motor) according to the following specifications.

#### DC voltage (analog input)

Item	Specifications
Connector type	BNC connector
Measurement range	50 Vpk, 20 Vpk, 10 Vpk, 5 Vpk, 2 Vpk, and 1 Vpk
Effective input range	±100% of the measurement range
Input impedance	Approx. 1 MΩ and 17 pF
Maximum allowable input	50 Vpk or 25 Vrms, whichever is less
Continuous maximum common mode voltage	600 Vrms (CAT II)

\* For other specifications, see chapter 17.

#### Pulse input

Item	Specifications
Connector type	BNC connector
Frequency range	1 Hz to 200 kHz
Amplitude input range	±5 V
Effective amplitude	1 V (Peak-to-Peak) or more
Input waveform	50% duty cycle square wave

### Torque Meter Signal Input Channel (CH8)

Input the signal output from the torque meter (a DC voltage (analog signal) that is proportional to the torque of the motor) according to the following specifications.

Item	Specifications
Connector type	BNC connector
Measurement range	50 Vpk, 20 Vpk, 10 Vpk, 5 Vpk, 2 Vpk, and 1 Vpk
Effective input range	±100% of the measurement range
Input impedance	Approx. 1 MΩ and 17 pF
Maximum allowable input	50 Vpk or 25 Vrms, whichever is less
Continuous maximum common mode voltage	600 Vrms (CAT II)

\* For other specifications, see chapter 17.

### Precautions when displaying the measurement functions of the motor module in the harmonic measurement mode

For the meanings of the measurement function symbols used in the explanation below, see section 15.2 and the following sections or appendix 2.

- The numerical data of Speed, Torque, Sync, Slip, Pm,  $\eta mA$ , and  $\eta mB$  are 0th order (DC) components. The default setting of the minimum order (Min Order) in the harmonic measurement mode is 1. To display the numerical data of Speed, Torque, Sync, Slip, Pm,  $\eta mA$ , and  $\eta mB$ , the minimum order must be set to 0.
- The numerical data of Torque in the normal measurement mode are simple averaged values. The numerical data of each harmonic component and the total of Torque in the harmonic measurement mode are RMS values. The numerical data that correspond to the same value as the normal measurement mode are displayed at Trq(dc).
- The 0th (DC) component of Speed and Pm are displayed as total numerical data.
- The numerical data of Sync and Slip are displayed only when the PLL source (PII Source) and frequency synchronization source (Sync Speed Source) are set to the same channel.
- $\eta mA$  displays the ratio of Pm total with respect to  $P\Sigma A$  total;  $\eta mB$  displays the ratio of Pm total with respect to  $P\Sigma B$  total.

# 15.2 Setting the Input Range of Revolution Sensor and Torque Meter Signals

## Keys

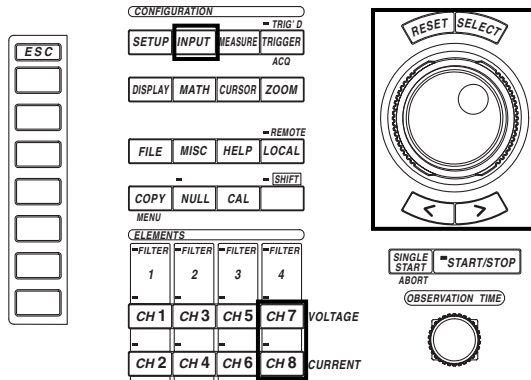

- The   mark indicates the keys that are used for the operation.
- To exit the menu during operation, press the ESC key.

## Procedure

### Setting the Input Range Using the Full Screen Menu

1. Press the INPUT key to display the Input setting menu.
2. Press the [Motor Module] soft key to display the motor module setting dialog box.

On products (PZ4000) with firmware version before 2.01, only the [Power Module] soft key appears and you cannot set the motor module. In addition, if the motor module is not installed in the element number 4 slot, the [Motor Module] menu does not appear.

### Selecting the input range of the revolution sensor signal

- When [Analog] is selected in the latter section “Selecting the revolution sensor signal type”
3. Turn the jog shuttle to select [Range] under Speed(Ch7).
  4. Press the SELECT key to display the input range selection box.
  5. Turn the jog shuttle to select the range from [50Vpk] to [1Vpk] and [Auto].
  6. Press the SELECT key to confirm the new input range.
- When [Pulse] is selected in the latter section “Selecting the revolution sensor signal type”
- The input range is fixed to [5Vpk].

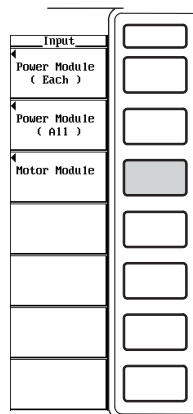

Selectable when the revolution sensor signal type is [Analog].

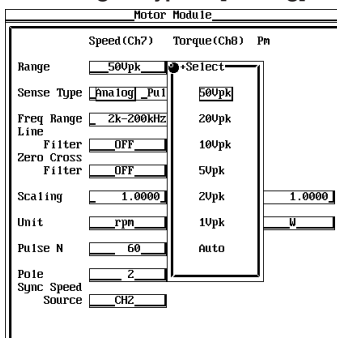

Fixed to [5Vpk] when the revolution sensor signal type is [Pulse].

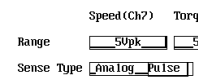

## 15.2 Setting the Input Range of Revolution Sensor and Torque Meter Signals

### Selecting the input range of the torque meter signal

7. Turn the jog shuttle to select [Range] under Torque(Ch8).
8. Press the SELECT key to display the input range selection box.
9. Turn the jog shuttle to select the range from [50Vpk] to [1Vpk] and [Auto].
10. Press the SELECT key to confirm the new input range.

### Selecting the revolution sensor signal type

11. Turn the jog shuttle to select [Sense Type].
12. Press the SELECT key to select [Analog] or [Pulse].

### Selecting the frequency input range of the revolution sensor signal

(The selection made here takes effect when [Pulse] is selected in the previous section “Selecting the revolution sensor signal type”)

13. Turn the jog shuttle to select [Freq Range].
14. Press the SELECT key to display the frequency input range selection box.
15. Turn the jog shuttle to select the range from [2k-200kHz] to [1-40Hz] and [Auto].
16. Press the SELECT key to confirm the new frequency input range.

Motor Module

Speed (Ch7) Torque (Ch8) Pn

Range 50pk 50pk Select

Sense Type Analog Pulse

Freq Range 2k-200kHz

Filter OFF

Zero Cross Filter OFF

Scaling 1.0000 1.0000

Unit rpm Nm

Pulse N 60

Pole 2

Sync Speed Source CHZ

50pk  
200pk  
100pk  
50pk  
20pk  
10pk  
Auto

Motor Module

Speed (Ch7) Torque (Ch8) Pn

Range 50pk 50pk

Sense Type Analog Pulse

Freq Range 2k-200kHz Select

Filter OFF

Zero Cross Filter OFF

Scaling 1.0000 16-800 Hz 1.0000

Unit rpm 1-40 Hz U

Pulse N 60 Auto

Pole 2

Sync Speed Source CHZ

### Setting the Input Range of the Revolution Sensor Signal Using the Channel Setting Menu

1. Press the CH7 key to display the channel setting menu.  
On products (PZ4000) with firmware version before 2.01 or when the motor module is not installed in the element number 4 slot, the revolution sensor input range setting menu does not appear.

#### Selecting the revolution sensor signal type

2. Press the [Sense Type] key to select [Analog] or [Pulse].

#### Selecting the input range of the revolution sensor signal

- When [Analog] is selected in the previous section “Selecting the revolution sensor signal type”

3. Press the [Sensor Range] soft key to display the input range selection box.
4. Turn the jog shuttle to select the range from [50Vpk] to [1Vpk] and [Auto].
5. Press the SELECT key to confirm the new input range.

- When [Pulse] is selected in the previous section “Selecting the revolution sensor signal type”

The input range is fixed to [5Vpk].

#### Selecting the frequency input range of the revolution sensor signal

(The menu appears when [Pulse] is selected in the previous section “Selecting the revolution sensor signal type”)

6. Press the [Freq Range] soft key to display the frequency input range selection box.
7. Turn the jog shuttle to select the range from [2k-200kHz] to [1-40Hz] and [Auto].
8. Press the SELECT key to confirm the new frequency input range.

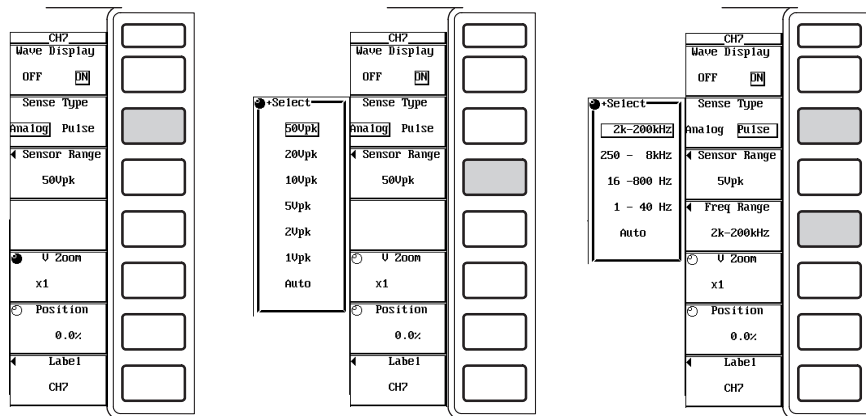



**Setting the Input Range of the Torque Meter Signal Using the Channel Setting Menu**

1. Press the CH8 key to display the channel setting menu.  
 On products (PZ4000) with firmware version before 2.01 or when the motor module is not installed in the element number 4 slot, the torque meter input range setting menu does not appear.

**Selecting the input range of the torque meter signal**

2. Press the [Sensor Range] soft key to display the input range selection box.
3. Turn the jog shuttle to select the range from [50Vpk] to [1Vpk] and [Auto].
4. Press the SELECT key to confirm the new input range.

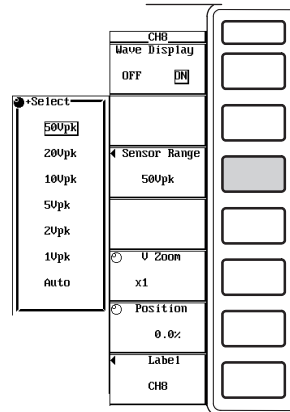

**Explanation**

Signals from revolution sensors and torque meters can be input to channels 7 and 8 of the PZ4000 for making measurements. For revolution sensors, the signal is the DC voltage (analog signal) or the pulse count that are proportional to the rotating speed of the motor. For torque meters, it is the DC voltage (analog signal) that is proportional to the torque of the motor.

**Selecting the revolution sensor signal type**

Select from the following list of choices:

- Analog  
 Select this when the revolution sensor signal type is a DC voltage (analog signal).
- Pulse  
 Select this when the revolution sensor signal type is a pulse signal.

**Selecting the input range of the revolution sensor signal**

Two types of range settings are available: fixed range and auto range.

- **Fixed range**
  - When the revolution sensor signal type is [Analog]  
 Select from the following input ranges:  
 50Vpk, 20Vpk, 10Vpk, 5Vpk, 2Vpk, and 1Vpk.
  - When the revolution sensor signal type is [Pulse]  
 Fixed to 5Vpk.
- **Auto range**  
 Select [Auto] for the input range setting to enable auto range. The range changes automatically depending on the amplitude of the input signal. The switching conditions and precautions are the same as the descriptions given in section 5.3, "Setting the Measurement Range during Direct Input." The different ranges used in the auto mode are the same as those available for fixed range.

**Selecting the frequency input range of the revolution sensor signal**

The selection made here takes effect when the revolution sensor signal type is set to [Pulse]. Two types of range settings are available: fixed range and auto range.

• **Fixed range**

Select from the following frequency input ranges:  
2k-200kHz, 250-8kHz, 16-800Hz, and 1-40Hz.

• **Auto range**

Select [Auto] for the frequency input range setting to enable auto range. The range changes automatically depending on the frequency of the input signal. The switching conditions and precautions are indicated below. The different ranges used in the auto mode are the same as those available for fixed range.

Frequency Input Range	Conditions for Stepping Up or Down the Range
2k-200kHz	Stepping down There is at least one data point that is less than or equal to 2 kHz within the observation time. No change All data points are greater than 2 kHz within the observation time.
250-8kHz	Stepping up There is at least one data point that is greater than or equal to 5 kHz within the observation time. Stepping down There is at least one data point that is less than or equal to 250 Hz within the observation time. No change • All data points are greater than 250 Hz and less than 5 kHz within the observation time. or • There is at least one data point that is less than or equal to 250 Hz and another point that is greater than or equal to 5 kHz within the observation time.
16-800Hz	Stepping up There is at least one data point that is greater than or equal to 312.5 Hz within the observation time. Stepping down There is at least one data point that is less than or equal to 15.625 Hz within the observation time. No change • All data points are greater than 15.625 Hz and less than 312.5 Hz within the observation time. or • There is at least one data point that is less than or equal to 15.625 Hz and another point that is greater than or equal to 312.5 kHz within the observation time.
1-40Hz	Stepping up There is at least one data point that is greater than or equal to 19.53125 Hz within the observation time. No change All data points are less than 19.53125 Hz within the observation time.

**Note**

- When a frequency below the lower limit of each frequency input range (16 Hz of range [16-800Hz], for example) is input, [-----] may be displayed. During cursor measurement, zero may be displayed.
- When a signal with a frequency higher than the frequency input range is input, the frequency cannot be measured correctly due to aliasing (see section 1.6). This may cause erroneous operation to go undetected. Consequently, the measurement functions related to the revolution sensor signal may not be determined correctly. Always input a signal within the selected frequency input range.

## 15.2 Setting the Input Range of Revolution Sensor and Torque Meter Signals

---

### Selecting the input range of the torque meter signal

Two types of range settings are available: fixed range and auto range.

- **Fixed range**

Select from the following input ranges:

50Vpk, 20Vpk, 10Vpk, 5Vpk, 2Vpk, and 1Vpk.

- **Auto range**

Select [Auto] for the input range setting to enable auto range. The range changes automatically depending on the amplitude of the input signal. The switching conditions and precautions are the same as the descriptions given in section 5.3, "Setting the Measurement Range during Direct Input." The different ranges used in the auto mode are the same as those available for fixed range.

# 15.3 Selecting the Input Filter

## Keys

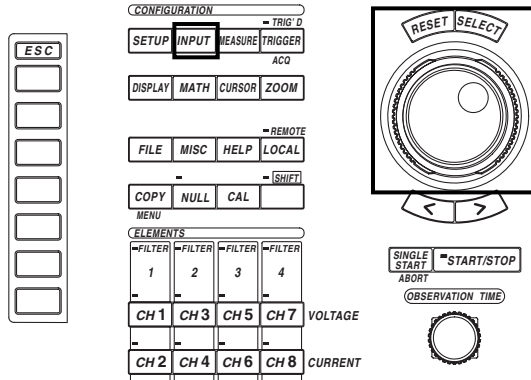

- The   mark indicates the keys that are used for the operation.
- To exit the menu during operation, press the ESC key.

## Procedure

1. Press the INPUT key to display the Input setting menu.
2. Press the [Motor Module] soft key to display the motor module setting dialog box.

On products (PZ4000) with firmware version before 2., only the [Power Module] soft key appears and you cannot set the motor module. In addition, if the motor module is not installed in the element number 4 slot, the [Motor Module] menu does not appear.

### Selecting the line filter

3. Turn the jog shuttle to select [Line Filter].
4. Press the SELECT key to display the line filter selection box.
5. Turn the jog shuttle to select the filter from [OFF] to [500Hz].
6. Press the SELECT key to confirm the line filter. The same filter is set for CH7 and CH8.

### Selecting the zero crossing filter

3. Turn the jog shuttle to select [Zero Cross Filter].
4. Press the SELECT key to display the zero crossing filter selection box.
5. Turn the jog shuttle to select the filter from [OFF] to [500Hz].
6. Press the SELECT key to confirm the zero crossing filter. The same filter is set for CH7 and CH8.

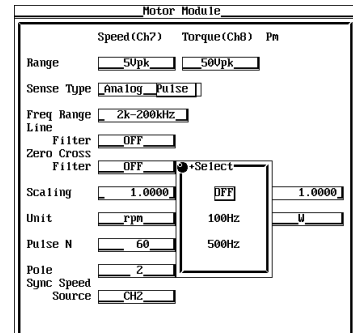
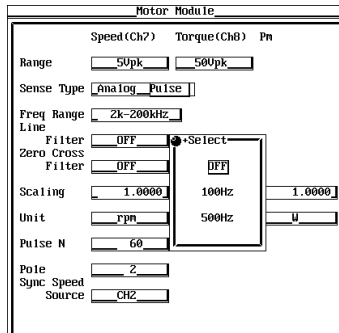
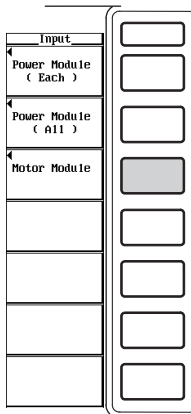

## 15.3 Selecting the Input Filter

---

### Explanation

The following two types of filters are available on the motor module.

#### Selecting the line filter

This filter is inserted into the circuit (CH7 and CH8) that measures the revolution sensor and torque meter signals. It eliminates harmonic noise. The cutoff frequency can be selected from the list of choices below. Selecting OFF disables the filter. OFF, 100Hz, and 500Hz.

#### Selecting the zero crossing filter

This filter is inserted only into the frequency measurement circuit. Zero crossing refers to the point at which the input signal crosses the center level of the amplitude. This filter is used to accurately detect the zero cross point. This instrument detects the zero crossing point with a hysteresis of approximately 3.5% of the specified input range of the revolution sensor signal or torque meter signal (see section 15.2). The cutoff frequency can be selected from the list of choices below. When the zero crossing filter is OFF and the line filter (above) is ON, the cutoff frequency specified by the line filter is used as a zero crossing filter. OFF, 100Hz, and 500Hz.

#### Note

---

- The line filter and zero crossing filter functions of CH7 do not operate when the signal type of the revolution sensor is set to [Pulse].
  - The input filter can be used to remove the noise from the signal when the revolution sensor signal or torque meter signal is used as a PLL source (see section 6.4) for harmonic measurement.
-

# 15.4 Setting the Scaling Factor, the Pulse Count, and Unit Used to Measure the rotating speed

## Keys

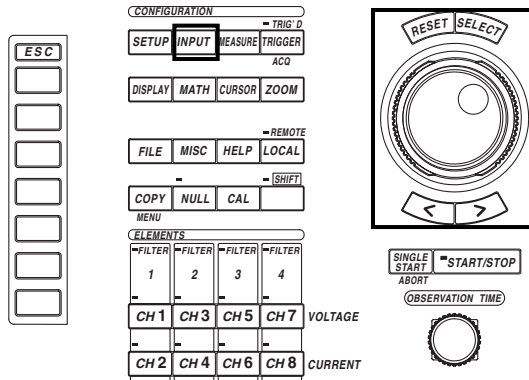

- The   mark indicates the keys that are used for the operation.
- To exit the menu during operation, press the ESC key.

## Procedure

1. Press the INPUT key to display the Input setting menu.
2. Press the [Motor Module] soft key to display the motor module setting dialog box.

On products (PZ4000) with firmware version before 2.01, only the [Power Module] soft key appears and you cannot set the motor module. In addition, if the motor module is not installed in the element number 4 slot, the [Motor Module] menu does not appear.

### Setting the scaling factor used to transform the revolution sensor signal

3. Turn the jog shuttle to select [Scaling] under Speed(Ch7).
4. Press the SELECT key to display the scaling factor setting box.
5. Turn the jog shuttle to set the scaling factor.  
For the procedures related to entering values using the jog shuttle, see section 4.1, "Entering Values and Strings."
6. Press the SELECT key or the ESC key to close the setting box.

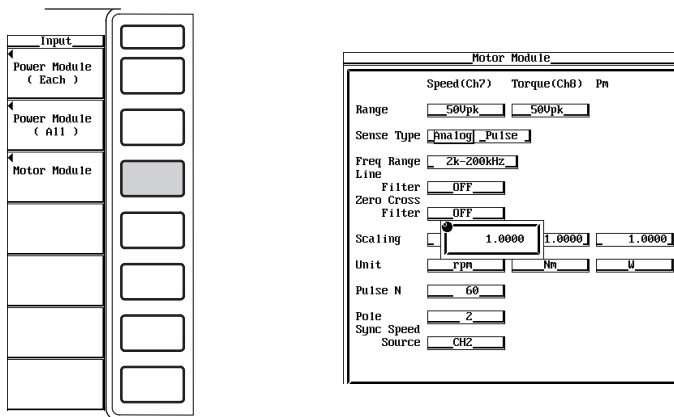

## 15.4 Setting the Scaling Factor, the Pulse Count, and Unit Used to Measure the rotating speed

### Setting the pulse count per rotation when the revolution sensor signal type is set to [Pulse]

3. Turn the jog shuttle to select [Pulse N].
4. Press the SELECT key to display the pulse count setting box.
5. Turn the jog shuttle to set the pulse count.  
For the procedures related to entering values using the jog shuttle, see section 4.1, "Entering Values and Strings."
6. Press the SELECT key or the ESC key to close the setting box.

The screenshot shows the 'Motor Module' settings interface. The 'Sense Type' is set to 'Pulse'. The 'Pulse N' field is currently set to 60. Other settings include: Range (50Upk), Torque (50Upk), Freq Range (2k-200kHz), Filter (OFF), Zero Cross Filter (OFF), Scaling (1.0000), Unit (rpm), Pole (2), and Sync Speed Source (CH2).

### Setting the unit of rotating speed

3. Turn the jog shuttle to select [Unit] under Speed(Ch7).
4. Press the SELECT key. A keyboard appears.
5. Use the keyboard to set the unit.  
For keyboard operation, see section 4.1, "Entering Values and Strings."

The screenshot shows the 'Motor Module' settings interface with a keyboard overlay. The 'Unit' field is highlighted, and the keyboard shows 'rpm' entered. The keyboard also displays numbers 1-0, letters A-Z, and function keys like INSERT, DEL, and ESC.

**Explanation**

**Setting the scaling factor**

You can specify the scaling factor used to transform the revolution sensor signal. Select the scaling factor in the range from 0.0001 to 99999.9999.

- **When the revolution sensor signal type is [Analog]**

By setting the number of rotations per volt of input voltage, the rotating speed is derived from the following equation.

$$\begin{aligned} &\text{Speed (rotating speed)} \\ &= \text{Scaling factor} \times \text{Input voltage from the revolution sensor} \end{aligned}$$

- **When the revolution sensor signal type is [Pulse]**

The value is used as a scaling factor in the equation given in the next item "Setting the pulse count."

**Setting the pulse count**

Set the pulse count per rotation. Select the value in the range from 1 to 9999. This takes effect when the revolution sensor signal type is set to [Pulse] in section 15.2.

$$\begin{aligned} &\text{Speed (rotating speed)} \\ &= \frac{\text{Number of input pulses from the revolution sensor}^{*1}}{\text{Pulse count (pulse count per revolution)}} \times \text{Scaling factor}^{*2} \end{aligned}$$

\*1 When the number of input pulses from the revolution sensor is measured in one minute intervals, the unit of rotating speed is rpms.

\*2 When the revolution sensor signal is a changed signal, you can set the scaling factor (see previous item) to determine the rotating speed before the change.

**Setting the unit of rotating speed**

- Number of characters  
Eight characters or less.
- Types of characters  
Characters that are displayed on the keyboard or a space.



# 15.5 Setting the Scaling Factor and Unit Used to Measure the Torque

## Keys

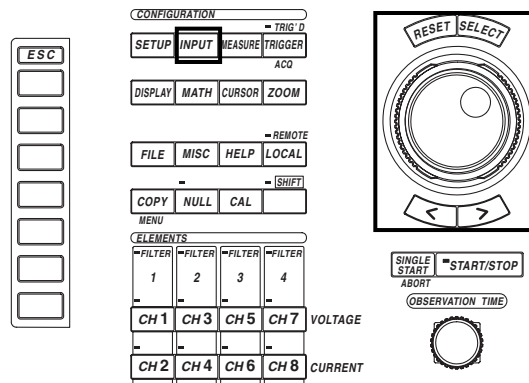

- The   mark indicates the keys that are used for the operation.
- To exit the menu during operation, press the ESC key.

## Procedure

1. Press the INPUT key to display the Input setting menu.
2. Press the [Motor Module] soft key to display the motor module setting dialog box.
 

On products (PZ4000) with firmware version before 2.01, only the [Power Module] soft key appears and you cannot set the motor module. In addition, if the motor module is not installed in the element number 4 slot, the [Motor Module] menu does not appear.

### Setting the scaling factor used to transform the torque meter signal

3. Turn the jog shuttle to select [Scaling] under Torque(Ch8).
4. Press the SELECT key to display the scaling factor setting box.
5. Turn the jog shuttle to set the scaling factor.
 

For the procedures related to entering values using the jog shuttle, see section 4.1, "Entering Values and Strings."
6. Press the SELECT key or the ESC key to close the setting box.

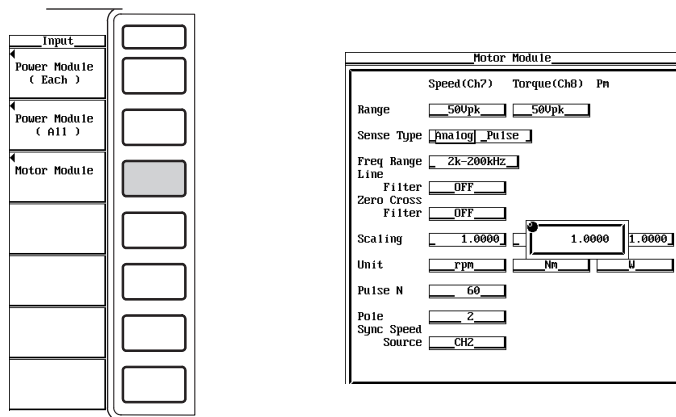

**Setting the unit of torque**

3. Turn the jog shuttle to select [Unit] under Torque(Ch8).
4. Press the SELECT key. A keyboard appears.
5. Use the keyboard to set the unit.

For keyboard operation, see section 4.1, "Entering Values and Strings."

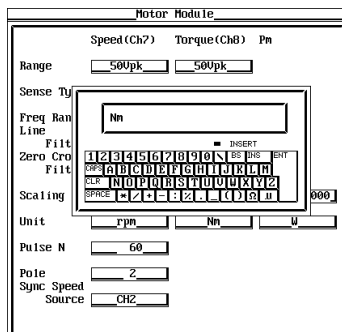

**Explanation**

**Setting the scaling factor**

You can specify the scaling factor used to transform the torque meter signal to the torque of the motor. Select the value in the range from 0.0001 to 99999.9999. By setting the torque per volt of input voltage, the torque is derived from the following equation.

$$\text{Torque} = \text{Scaling factor} \times \text{Input voltage from the torque meter}$$

**Setting the unit of torque**

- Number of characters  
Eight characters or less.
- Types of characters  
Characters that are displayed on the keyboard or a space.

**Note**

- To set the unit of the motor output that is determined in section 15.7 to "Ω," set the unit of torque to Nm.
- When the unit of torque is set to "Nm" (see section 15.5), the motor output is determined in terms of "Ω." If the unit of torque is set to some other unit, the unit of motor output can be converted to "Ω" by multiplying the conversion value in the table below.

Unit of Torque	Conversion Value
Nm	1.0000
kgfm	9.80665
ftlb	1.35582
ozin	0.00706155
lbin	0.112985

# 15.6 Setting the Motor's Number of Poles Used to Compute the Synchronous Speed and the Slip

## Keys

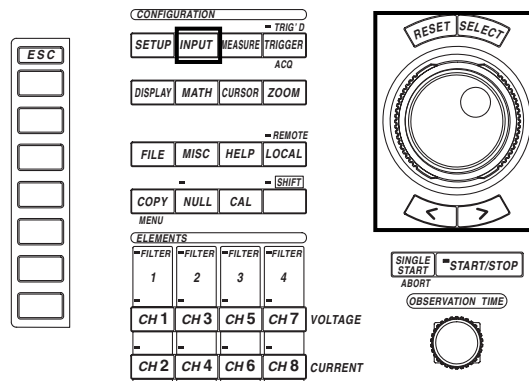

- The   mark indicates the keys that are used for the operation.
- To exit the menu during operation, press the ESC key.

## Procedure

1. Press the INPUT key to display the Input setting menu.
2. Press the [Motor Module] soft key to display the motor module setting dialog box.
 

On products (PZ4000) with firmware version before 2.01, only the [Power Module] soft key appears and you cannot set the motor module. In addition, if the motor module is not installed in the element number 4 slot, the [Motor Module] menu does not appear.

### Setting the motor's number of poles

3. Turn the jog shuttle to select [Pole].
4. Press the SELECT key to display the motor's number of poles selection box.
5. Turn the jog shuttle to set the number of poles.
 

For the procedures related to entering values using the jog shuttle, see section 4.1, "Entering Values and Strings."
6. Press the SELECT key or the ESC key to close the setting box.

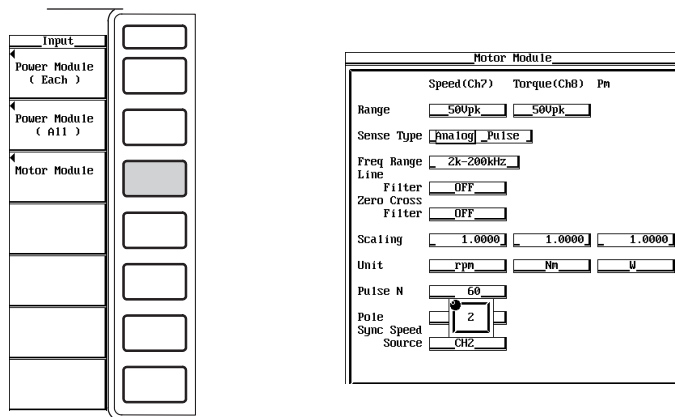

**Setting the frequency measurement source (input channel for the voltage or current supplied by the motor)**

3. Turn the jog shuttle to select [Sync Speed Source].
4. Press the SELECT key to display the frequency measurement source setting box.
5. Turn the jog shuttle to select the channel from [CH1] to [CH8].
6. Press the SELECT key to confirm the new frequency measurement source.

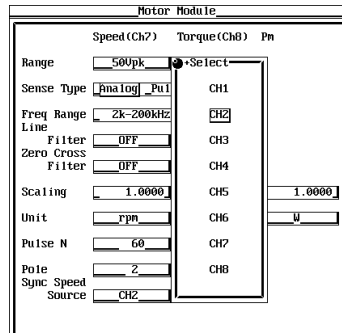

**Explanation**

**Setting the motor's number of poles**

Select the value in the range from 1 to 99. This sets the number of poles for the motor being measured.

**Setting the frequency measurement source**

Select from the following list of choices:

- CH1 to CH6  
Normally, set the input channel for the voltage or current supplied by the motor. If a frequency other than that of the voltage and current supplied by the motor is specified, the synchronous speed may not be determined correctly.
- CH7 or CH8  
Normally, the rotating speed and torque signals are input to CH7 and CH8. You can select the signal input to these channels as the frequency measurement source, but the synchronous speed will not be determined correctly.

**Equation for deriving the synchronous speed**

The equation when the unit of synchronous speed (Sync) is rpms is indicated below.

$$\text{Sync (rpm)} = \frac{120 \times \text{Frequency of the frequency measurement source (Hz)}}{\text{Motor's number of poles}}$$

**Equation for deriving the slip**

The equation when the unit of rotating speed or synchronous speed is rpms is indicated below.

$$\text{Slip (\%)} = \frac{\text{Synchronous speed (rpm)} - \text{Rotating speed}^* (\text{rpm})}{\text{Synchronous speed (rpm)}} \times 100$$

\* Rotating speed derived in section 15.4.

**Note**

Please select a stable voltage or current (supplied by the motor) with small distortion or noise for the frequency measurement source. Set the zero crossing filter (see section 5.6) as necessary.

# 15.7 Setting the Scaling Factor and Unit Used to Compute the Motor Output

## Keys

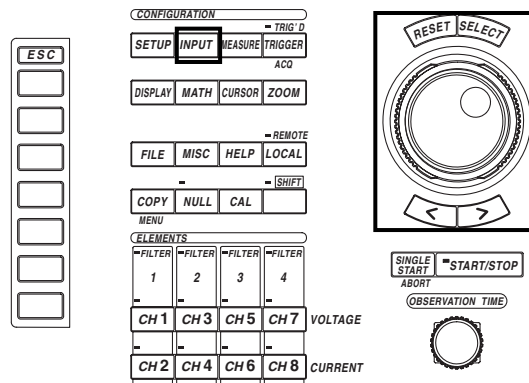

- The   mark indicates the keys that are used for the operation.
- To exit the menu during operation, press the ESC key.

## Procedure

1. Press the INPUT key to display the Input setting menu.
2. Press the [Motor Module] soft key to display the motor module setting dialog box.
 

On products (PZ4000) with firmware version before 2.01, only the [Power Module] soft key appears and you cannot set the motor module. In addition, if the motor module is not installed in the element number 4 slot, the [Motor Module] menu does not appear.

### Setting the Scaling Factor Used to Compute the Motor Output

3. Turn the jog shuttle to select [Scaling] under Pm.
4. Press the SELECT key to display the scaling factor setting box.
5. Turn the jog shuttle to set the scaling factor.
 

For the procedures related to entering values using the jog shuttle, see section 4.1, "Entering Values and Strings."
6. Press the SELECT key or the ESC key to close the setting box.

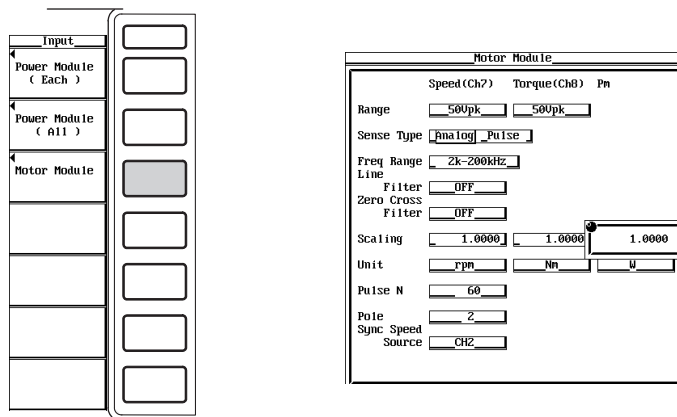

**Setting the unit of motor output**

3. Turn the jog shuttle to select [Unit] under Pm.
4. Press the SELECT key. A keyboard appears.
5. Use the keyboard to set the unit.

For keyboard operation, see section 4.1, "Entering Values and Strings."

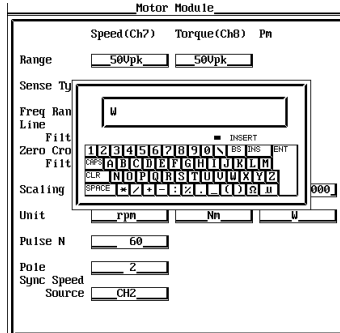

**Explanation**

**Setting the scaling factor**

You can specify the scaling factor used to compute the motor output (mechanical power) from the rotating speed and torque. Select the value in the range from 0.0001 to 99999.9999. The equation is indicated below. When the scaling factor is "1" in the following equation, the normal motor output is determined.

$$\text{Motor output Pm(W)} = \text{Scaling factor} \times \text{Torque}^*1 \text{ (N}\cdot\text{m)} \times \frac{2 \times \pi \times \text{Rotating speed}^*2 \text{ (rpm)}}{60}$$

\*1 Torque derived in section 15.5.

\*2 Rotating speed derived in section 15.4.

**Setting the unit of motor output**

- Number of characters  
Eight characters or less.
- Types of characters  
Characters that are displayed on the keyboard or a space.

**Note**

- To set the unit of the motor output that is determined in section 15.7 to "Ω," set the unit of torque to Nm.
- When the unit of torque is set to "Nm" (see section 15.5), the motor output is determined in terms of "Ω." If the unit of torque is set to some other unit, the unit of motor output can be converted to "Ω" by multiplying the conversion value in the table below.

Unit of Torque	Conversion Value
Nm	1.0000
kgfm	9.80665
ftlb	1.35582
ozin	0.00706155
lbin	0.112985

## 15.8 Computing the Motor Efficiency and Total Efficiency

From the active power measured by the power measurement module and the motor output determined in section 15.7, the PZ4000 can compute the motor efficiency (ratio of the motor output versus the power consumption by the motor) and total efficiency (ratio of the motor output versus the power consumption by the motor as well as the converter through which power is fed to the motor). Computation examples are indicated below.

### When the Motor Input Is a Three-Phase Four-Wire System (3P4W)

- Wire (see chapter 3) the motor input to elements 1, 2, and 3.
- Select [3P4W] for the wiring method (see sections 3.7 and 5.2).

$$\text{Motor efficiency } \eta_{mA}(\%) = \frac{\text{Motor output}^* (W)}{\Sigma A(W)} \times 100$$

\* Motor output derived in section 15.7.

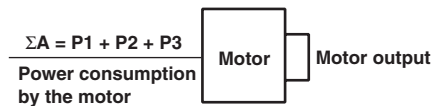

### When the Converter Input and Motor Input Are Both Single-Phase Two-Wire Systems (1P2W)

- Wire the converter input to element 1 and the motor input to element 2.
- Select [1P2W-1P2W] for the wiring method.

$$\text{Motor efficiency } \eta_{mB}(\%) = \frac{\text{Motor output}^* (W)}{\Sigma B(W)} \times 100$$

$$\text{Total efficiency } \eta_{mA}(\%) = \frac{\text{Motor output}^* (W)}{\Sigma A(W)} \times 100$$

\* Motor output derived in section 15.7.

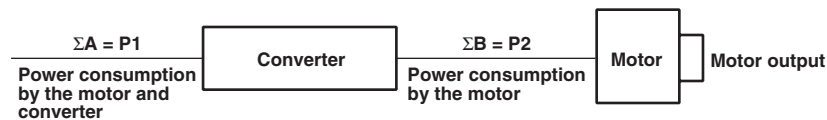

### When the Converter Input Is a Single-Phase Two-Wire System (1P2W) and the Motor Input Is a Three-Phase Three-Wire System (3P3W)

- Wire the converter input to element 1 and the motor input to elements 2 and 3.
- Select [1P2W-3P3W] for the wiring method.

$$\text{Motor efficiency } \eta_{mB}(\%) = \frac{\text{Motor output}^* (W)}{\Sigma B(W)} \times 100$$

$$\text{Total efficiency } \eta_{mA}(\%) = \frac{\text{Motor output}^* (W)}{\Sigma A(W)} \times 100$$

\* Motor output derived in section 15.7.

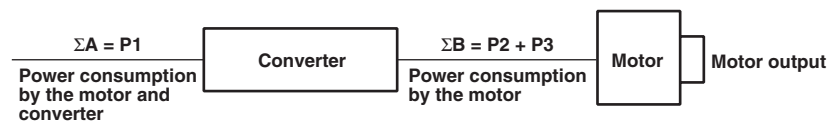

**When the Converter Input Is a Single-Phase Two-Wire System (1P2W) and the Motor Input Is a Three-Phase Three-Wire System (3P3W)**

- Wire the motor input to elements 1 and 2 and the converter input to element 3.
- Select [3P3W-1P2W] for the wiring method.

$$\text{Motor efficiency } \eta_{mA}(\%) = \frac{\text{Motor output}^* (W)}{\Sigma A(W)} \times 100$$

$$\text{Total efficiency } \eta_{mA}(\%) = \frac{\text{Motor output}^* (W)}{\Sigma B(W)} \times 100$$

\* Motor output derived in section 15.7.

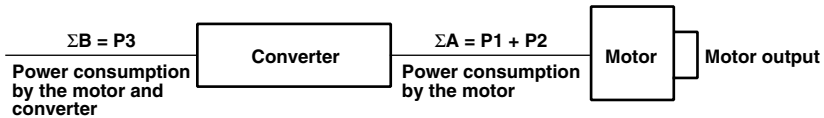

**Note**

With this wiring method, delta computation function (see section 10.2) can be used to carry out 3P3W>3V3A transformation or Delta>Star transformation.

- From the 3P3W>3V3A transformation, you can determine one set of line voltage and common mode current that is not being measured.
- From the Delta>Star transformation, three common mode voltages can be determined from three line voltages.

**When the Converter Input Is a Three-Phase Three-Wire System (3P3W) and the Motor Input Is a Single-Phase Two-Wire System (1P2W)**

- Wire the converter input to elements 1 and 2 and the motor input to element 3.
- Select [3P3W-1P2W] for the wiring method.

$$\text{Motor efficiency } \eta_{mB}(\%) = \frac{\text{Motor output}^* (W)}{\Sigma B(W)} \times 100$$

$$\text{Total efficiency } \eta_{mA}(\%) = \frac{\text{Motor output}^* (W)}{\Sigma A(W)} \times 100$$

\* Motor output derived in section 15.7.

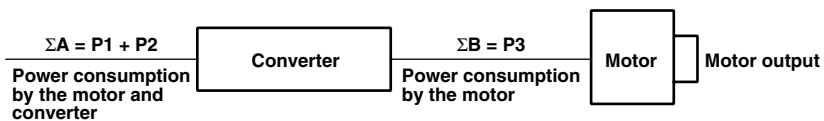



# 16.1 Troubleshooting

## Troubleshooting

- For the appropriate corrective actions when a message appears on the screen, see the following pages.
- If servicing is required or if the instrument does not operate properly after taking the following corrective actions, contact your nearest YOKOGAWA dealer.

Problem and Corrective Action	Sections
Nothing is displayed when the power is turned ON.	
Securely connect the power cord to the power connector of the instrument and the power outlet.	3.6
Set supply voltage within the permitted range.	3.6
Check the display settings.	14.3
Check that the fuse is not blown.	15.5
The displayed data are not correct.	
Check that the ambient temperature and humidity are within the specifications.	3.2
Check that noise is not affecting the measurement.	3.1, 3.4
Check the wiring of the measurement cable.	3.4 to 3.10
Check the wiring method.	3.7 to 3.10, 5.3
Check that the line filter is turned OFF.	5.7
Check the measurement/computation period settings.	10.1
Reboot the instrument.	3.11
Keys do not work.	
Check the REMOTE indicator. If the REMOTE indicator is ON, press the LOCAL key to turn it OFF.	—
Do a key test. If it is abnormal, the instrument needs servicing.	15.3
Triggering does not occur.	
Check the trigger conditions.	chap. 7
Check that the trigger source is being applied.	7.2
Cannot make harmonic measurements.	
Check the PLL source settings.	6.4
Check that the PLL source input signal is within the specifications.	6.4, chap. 17
Cannot print.	
The printer head may be damaged or worn out. The instrument needs servicing.	—
Cannot recognize the medium.	
Check that the cables are properly connected.	12.2
Check the format of the medium. If necessary, format the medium.	12.4
The medium may be damaged.	—
Cannot save data to the selected medium.	
Check the format of the medium. If necessary, format the medium.	12.4
Check that the write-protect is disabled.	—
Check the free space on the medium. Remove unnecessary files as necessary or use a new medium.	12.4
Cannot set or control the instrument via the communication interface.	
Check that the GP-IB address or the parameter settings of the serial interface satisfy the specifications.	—*
Check that the interface satisfies the electrical and mechanical specifications.	—*

\* See the Communication Interface User's Manual, IM253710-11E.

## 16.2 Error Messages and Corrective Actions

### Error Messages

There are cases in which error messages are displayed on the screen during operation. This section describes the meanings of the messages and the appropriate corrective actions. The messages can be displayed in English or Japanese (see section 15.2). If the corrective action indicates servicing, contact your nearest YOKOGAWA dealer for repairs.

In addition to the error messages listed in this section, there are also communication related error messages. These messages are described in the Communication Interface User's Manual (IM253710-11E).

### Error in Execution

Codes	Messages	Actions	Sections
601	Invalid file name or SCSI ID.	Check file name or SCSI ID.	12.3, 12.5
602	No media inserted or no SCSI device.	Make sure that the storage medium is inserted (if applicable), and check the SCSI device connection and the SCSI ID.	12.1 to 12.3
603	No SCSI device or no media inserted.	Check the SCSI device connection and the SCSI ID, and make sure that the storage medium is inserted (if applicable).	12.1 to 12.3
604	Media failure.	Check the storage medium.	—
605	File not found.	Check the file name and the storage medium.	—
606	Media is protected.	Set the disk's (medium's) write protect switch to OFF.	—
607	Media was removed while accessing.	Check the storage medium.	—
608 , 609	File already exists.	—	12.5
610	Contains invalid characters.	—	12.5
611, 612	Media full.	Delete unnecessary file(s) or use another disk.	12.4 to 12.7
613	File system failure.	Check using another disk. If the same message still appears, maintenance service is required.	—
614	File is protected.	—	12.8
615	Physical format error.	Reformat the medium. If the same error occurs, the instrument is probably unable to execute a format on this medium.	12.4
616 to 620	File system failure.	Check using another disk. If the same message still appears, maintenance service is required.	—
621	File is damaged.	Check the file.	—
622 to 641	File system failure.	Check using another disk. If the same message still appears, maintenance service is required.	—
642	No media exists in SCSI device.	Check that the storage medium is correctly inserted in the SCSI device.	—
643 to 653	Media failure.	Check the medium.	—
654	Media failure.	Check the format type of the floppy disk.	—
656 to 664	File system failure.	Check using another disk. If the same message still appears, maintenance service is required.	—
665	Cannot load this file format. File was stored on other models or other versions.	—	—
666	File is now being accessed.	Execute after access is made.	—
667	Cannot be executed while running.	Press START/STOP key to stop acquisition.	4.3
668	Cannot find '.HDR' file.	Check the file.	12.6

## 16.2 Error Messages and Corrective Actions

Codes	Messages	Actions	Sections
669	Cannot find '.INF' file.	Check the file.	—
670	No ch is displayed.	Turn ON the display of the appropriate channel.	9.1
671	Save data not found.	Check for presence of data.	12.5 to 12.7
672	This model does not have the SCSI interface.	—	page ii
673	SCSI controller failure.	Maintenance service is required.	—
674	Initializing file system.	Please wait.	—
675	Cannot load this file.	—	—
679	Printer error.	Maintenance service is required.	—
680	Move the release arm to the "HOLD" position.	—	13.1
681	Paper empty.	Load a roll chart.	13.1
682, 683	Printer over heat.	Power off immediately.	—
684	No built-in printer on this model.	Check the specifications to see whether or not the optional printer is provided.	page ii
685	Printer time out.	Maintenance service is required.	—
686	Centronics printer error.	Turn the power of the printer from OFF to ON.	—
687	Centronics printer off-line.	—	—
688	No paper.	—	—
689	Centronics interface in use.	—	—
690	Can't detect printer.	Turn ON the printer. Check connectors.	—
701, 702	Cannot be executed while running.	Press START/STOP key to stop acquisition.	4.3
703	There is no undo-data.	Undo is not possible since data which was present before initialization and auto set-up is now not available.	—
704	Can not be executed while running.	Press START/STOP key to stop acquisition.	4.3
705	Can not operate while accessing medium.	Wait until access has completed.	—
706	Can not operate during hard copy.	Wait until output has completed.	—
707	Can not Start while data out.	Wait until output is completed.	—
708	Can not data out while running.	Press START/STOP key to stop acquisition.	4.3
709	Unable to start. Accessing the medium.	Wait until the access to the medium completes.	—
710	File not found.	Check the file.	—
711	File operation not allowed during hard copy.	Wait until the hard copy completes.	—
712	Can not compress this hardcopy image.	Turn off compression switch.	13.4
713	Not enough data points for taking the FFT.	Make the observation time longer or widen the computation region.	11.1, 11.3

### Error in Setting

Codes	Messages	Actions	Sections
800	Illegal date-time.	Set the correct date and time.	3.12
801	Illegal file name.	The file name contains characters which are not allowed or the file name is not a valid MS-DOS file name. Enter another file name.	12.5
802	Cannot be set in the normal measurement mode.	Set the measurement mode to harmonic.	5.1
803	Cannot be set in the harmonic measurement mode.	Set the measurement mode to normal.	5.1
804	Cannot change this parameter while running.	Press the START/STOP key to stop acquisition.	4.3
805	Cannot change this parameter when averaging is ON.	Turn OFF the averaging function.	10.5
806	Cannot change this parameter when any of the user-defined functions is ON.	Turn OFF all user-defined functions.	10.3
807	Cannot change this parameter when either MATH1 or MATH2 is ON.	Turn OFF both MATH1 and MATH2.	11.2

## 16.2 Error Messages and Corrective Actions

Codes	Messages	Actions	Sections
808	Cannot change this parameter during numerical display.	—	—
809	Cannot change this parameter during vector display.	—	—
810	Cannot change this parameter during bar graph display.	—	—
814	Duplicated Name.	Change the label string.	9.7
817	Cannot change.	Please change X Trace in the X-Y menu.	9.11
819	Cannot change when Channel Display is OFF or Math settings are invalid.	Set the channel display ON or make appropriate Math settings.	9.1
823	Cannot change when started.	—	—
827	Illegal math expression.	Input a correct computing equation.	10.3, 11.2
834	Duplicate SCSI ID.	Set different ID numbers.	12.3
840	Illegal input value.	—	—

### Error in System Operation

Codes	Messages	Actions	Sections
901	Failed to backup setup data.	Will initialize.	3.11
902	System RAM failure.	Maintenance service is required.	—
903	System ROM failure.	Maintenance service is required.	—
904	System RAM failure.	Maintenance service is required	—
905	System failure.	Install the input modules correctly.	3.3
906	Fan stopped.	Power off immediately. Maintenance service is required.	—
907	Backup battery is flat.	Maintenance service is required to replace the backup battery.	—
908	Internal temperature is too high.	Power off immediately. Maintenance service is required.	—
909	Illegal SUM value.	Maintenance service is required.	—
910	RAM read/write error.	Maintenance service is required.	—
911	Memory bus error.	Maintenance service is required.	—
912	Fatal error in Communication-driver.	Maintenance service is required.	—
914	Time out occurs in Communications.	—	—
915	EEPROM SUM error.	EEPROM may be damaged. Maintenance service is required.	—
917	No module installed.	Install the module.	3.3
919	Module installation condition and setup parameters do not match.	The instrument is initialized.	—
920	SUM error of NULL value.	The Null value is reset to 0.	—

#### **Note**

If the corrective action indicates maintenance service, try initializing the instrument. It may recover from the error.

## 16.3 Performing a Self-test

### Keys

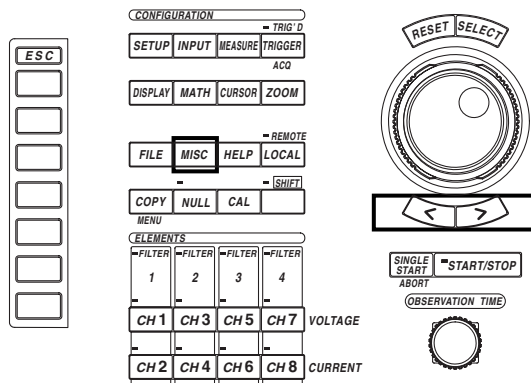

- The  mark indicates the keys that are used for the operation.
- To exit the menu during operation, press the ESC key.

### Procedure

1. Press the MISC key to display the Misc menu.
2. Press the [Selftest] soft key to display the self-test menu.
3. Press the [Test Item] soft key to display the test item selection menu.
4. Press the [Memory] or [Key Board] soft key to select the test item.  
If you selected [Memory], go to paragraph "Testing the memory" on the next page.  
If you selected [Key Board], go to paragraph "Testing the keys and the keyboard" on the next page.

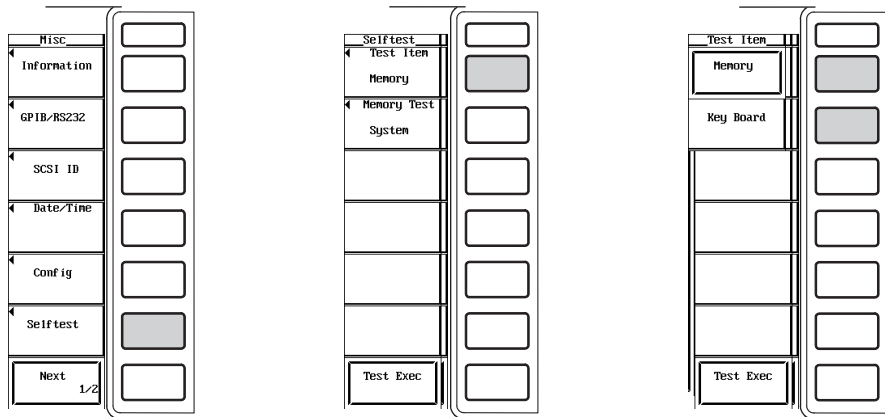

## 16.3 Performing a Self-test

### Testing the memory

5. Press the [Memory Test] soft key to display the memory selection menu.
6. Press one of the soft keys from [System] to [VRAM] to select the memory.
7. Press the [Test Exec] soft key to execute the test.

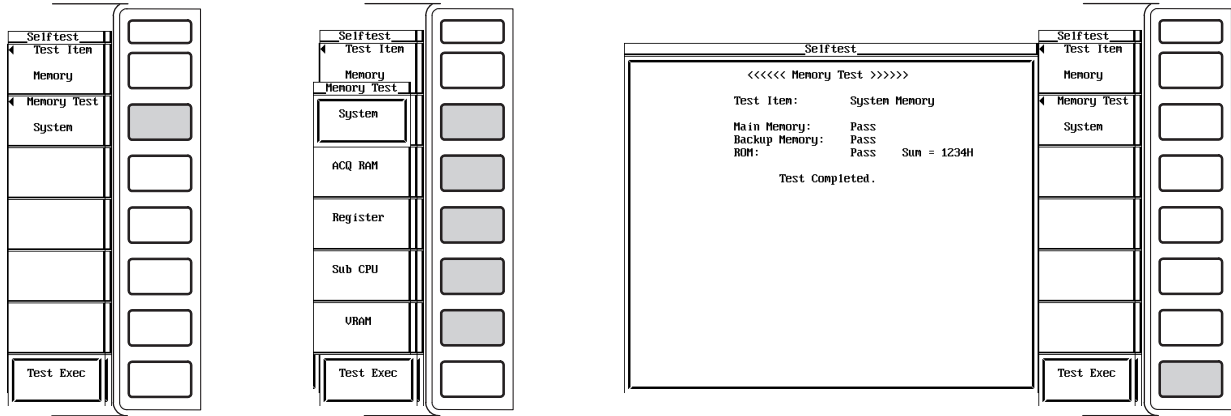

### Testing the keys and the keyboard

#### • Testing the keys

5. Press the [Test Exec] soft key.
6. Press the keys on the front panel to test them.
7. Press the arrow keys (< or >). The indicator lights one by one each time an arrow key is pressed.
8. Press the ESC key twice to exit from the key test.

#### • Testing the keyboard

9. Press the [Soft Key] soft key. A keyboard is displayed.
10. Operate the keyboard. Check that the characters entered on the keyboard are correctly displayed in the entry box of the keyboard.

For keyboard operation, see section 4.1, "Entering Values and Strings."

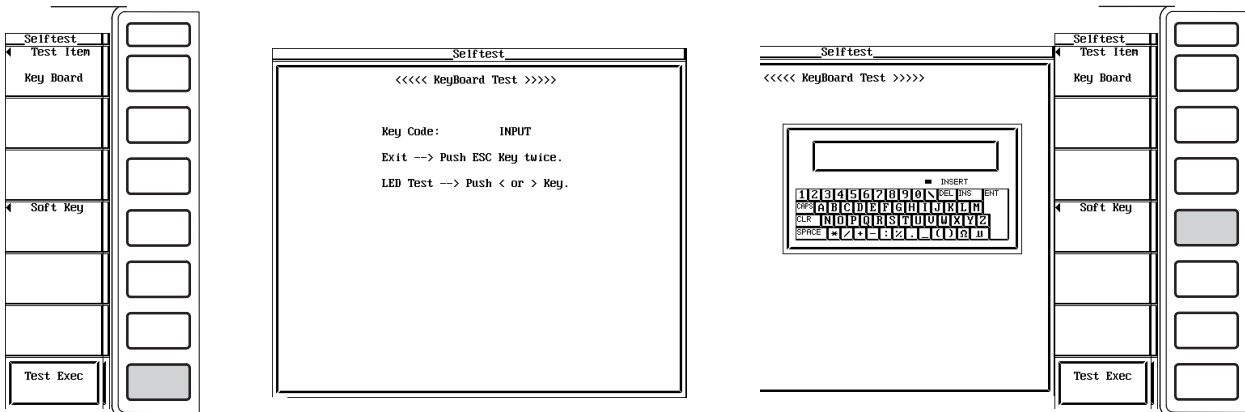

**Explanation****Testing the memory**

Tests whether or not the internal ROM or RAM is operating correctly. If [Pass] is displayed, it is operating correctly. If [Failed] is displayed, contact your nearest YOKOGAWA dealer.

**Testing the keys and the keyboard**

- Tests whether or not the front panel keys are operating properly. If the name of the key being pressed appears on the screen, it is operating correctly.
- If the indicator turns ON/OFF when the arrow keys (< or >) are pressed, the keys are operating correctly.
- To exit from the key test, press the ESC key twice.
- If the keys are not operating correctly, contact your nearest YOKOGAWA dealer.

## 16.4 Checking the System Conditions

### Keys

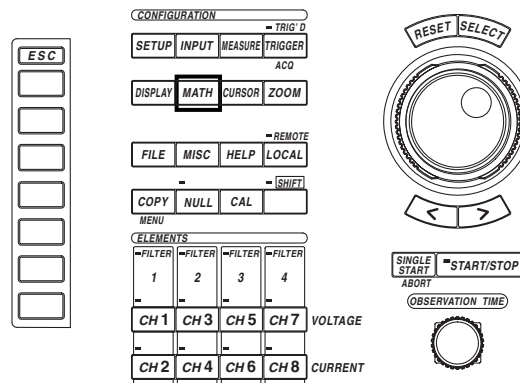

- The  mark indicates the keys that are used for the operation.
- To exit the menu during operation, press the ESC key.

### Procedure

1. Press the MISC key to display the Misc menu.
2. Press the [Information] soft key to display the information window.

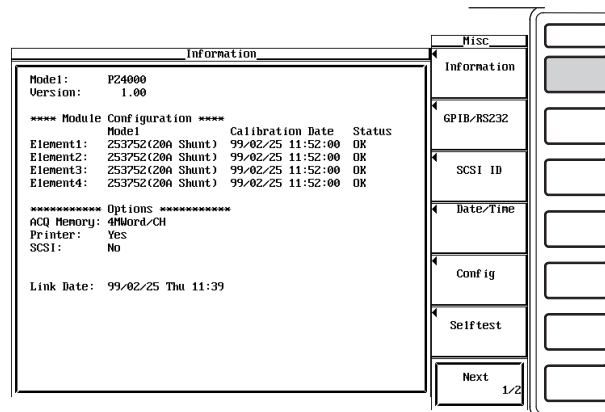

### Explanation

#### Displaying the system conditions

You can check the model, ROM version, module configuration, and the existence of options.



## 16.5 Replacing the Power Fuse



### WARNING

- To prevent the possibility of fire, use only a fuse having the specified rating (voltage, current, and type).
- Make sure to turn OFF the instrument and unplug the power cord before replacing the fuse.
- Never short the fuse holder.

### Specified Rating

The power fuse used on this instrument is specified as follows.

- Maximum rated voltage : 250 V
- Maximum rated current : 6.3 A
- Type : Time lag
- Standard : UL/VDE certified
- Part number : A1354EF

### Replacement Procedures

Follow the procedures below to replace the power fuse.

1. Turn OFF the power switch.
2. Unplug the power cord from the power outlet.
3. Place the tip of a Philips screwdriver in the dented section of the fuse holder on the power connector side and move the driver in the direction of the arrow to remove the fuse holder.
4. Take out the shortened fuse that is attached to the tip of the fuse holder.
5. Attach a new fuse to the holder and then place the fuse holder back in its original position.

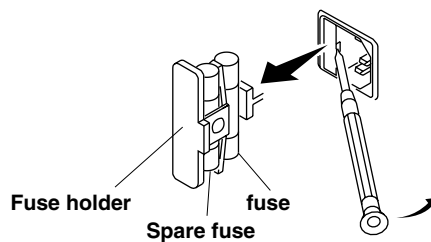

### Note

The user cannot replace the fuse that is located inside the case. If you believe the fuse inside the case is blown, contact your nearest YOKOGAWA dealer.

The ratings of the fuse that is used inside the case are shown below.

Location	Max. Rated Voltage	Max. Rated Current	Type	Standard
SCSI board	250 V	800 mA	Time lag	VDE/SEMKO certified

---

## 16.6 Recommended Replacement Parts

The three-year warranty applies only to the main unit of the instrument (starting from the day of delivery) and does not cover any other items nor expendable items (items which wear out). The replacement period for expendable items varies depending on the conditions of use. Refer to the table below as a general guideline. Contact your nearest YOKOGAWA dealer for replacement parts.

<b>Part Name</b>	<b>Recommended Replacement Period</b>
Built-in printer	Under normal usage, 120 rolls of paper (part No. : B9850NX)
Cooling fan	10000 hours
LCD backlight	3 years
Backup battery (Lithium battery)	3 years

## 17.1 Input

Item	Specification
Input type	Plug-in input
Number of slots	4
Maximum record length	100 k word/CH 1 M word/CH (option) 4 M word/CH (option)

## 17.2 Display

Item	Specification
Display	6.4" color TFT LCD monitor
Display resolution of entire screen*	640 (H) × 480 (V) dots
Display resolution waveform display*	501 (H) × 432 (V) dots
Display update rate	Depends on the observation time and record length. Approx. 2 s when the observation time is 100 ms, record length is 100 k-word, number of channels is eight, numerical computation is ON, and waveform computation is OFF in normal measurement mode. Approx. 2 s when the observation time is 100 ms, record length is 100 k-word, number of channels is eight, numerical computation is ON, and waveform computation is OFF in harmonic measurement mode.

\* In some cases, up to 0.02% of the total number of pixels of the LCD can be defective.

## 17.3 Time Axis

Item	Specification
Observation time	Normal measurement mode 10 μs to 1 ks (1, 2, 4 and their ten-fold multiples) Harmonic measurement mode Approx. 0.5 to 1.6 s when the record length is 100 k-word. Approx. 4.9 to 16.3 s when the record length is 1 M-word. Approx. 19.5 to 65.1 s when the record length is 4 M-word.
Time axis accuracy*	±0.005%
External clock input (EXT CLK IN)	connector type : BNC connector Frequency range : 1 kHz to 250 kHz Input level : CMOS Minimum pulse width : 1 μs for both High and Low.

\* Measured value under standard operating conditions (see section 17.13).

## 17.4 Measurement Function (Measurement Item)

### Measurement function in the normal measurement mode

Measurement functions that are determined for each element (power measurement module).

(For details related to the determination of and the equations of measurement functions, see “Appendix 2.”)

Item	Symbol and Meaning
Voltage (V)	Urms : true rms value, Umn : rectified mean value calibrated to the rms value, Udc : simple average, Uac : AC component
Current (A)	Irms : true rms value, Imn : rectified mean value calibrated to the rms value, Idc : simple average, Iac : AC component
Active power (W)	P
Apparent power (VA)	S
Reactive power(var)	Q
Power factor	$\lambda$
Phase difference (°)	$\phi$
Frequency (Hz)	fU : voltage frequency, fI : current frequency
Voltage max. and min. (V)	U+pk : Voltage maximum, U-pk : Voltage minimum
Current max. and min. (A)	I+pk : Current maximum, I-pk : Current minimum
Crest factor	CfU : Voltage crest factor, CfI : Current crest factor
Form factor	FfU : Voltage form factor, FfI : Current form factor
Impedance ( $\Omega$ ) of the load circuit	Z
Resistance and reactance ( $\Omega$ ) of the load circuit	Rs : Resistance of the load circuit that has a resistor R, inductor L, and capacitor C connected in series Xs : Reactance of the load circuit that has a resistor R, inductor L, and capacitor C connected in series Rp : Resistance of the load circuit that has a R, L, and C connected in parallel Xp : Reactance of the load circuit that has a R, L, and C connected in parallel
Corrected Power (W) (Applicable standard IEC76-1(1976), IEEE C57.12.90-1993, IEC76-1(1993))	Pc

### Measurement functions ( $\Sigma$ functions) that are determined for each selected wiring method (A, B)

(For details related to the determination of and the equations of  $\Sigma$ functions, see “Appendix 2.”)

Item	Symbol and Meaning
Voltage (V)	Urms $\Sigma$ : true rms value, Umn $\Sigma$ : rectified mean value calibrated to the rms value, Udc $\Sigma$ : simple average, Uac $\Sigma$ : AC component
Current (A)	Irms $\Sigma$ : true rms value, Imn $\Sigma$ : rectified mean value calibrated to the rms value, Idc $\Sigma$ : simple average, Iac $\Sigma$ : AC component
Active power (W)	P $\Sigma$
Apparent power (VA)	S $\Sigma$
Reactive power (var)	Q $\Sigma$
Power factor	$\lambda\Sigma$
Phase difference(°)	$\phi\Sigma$
Impedance ( $\Omega$ ) of the load circuit	Z $\Sigma$
Resistance and reactance ( $\Omega$ ) of the load circuit	Rs $\Sigma$ : Resistance of the load circuit that has a resistor R, inductor L, and capacitor C connected in series Xs $\Sigma$ : Reactance of the load circuit that has a resistor R, inductor L, and capacitor C connected in series Rp $\Sigma$ : Resistance of the load circuit that has a R, L, and C connected in parallel Xp $\Sigma$ : Reactance of the load circuit that has a R, L, and C connected in parallel
Corrected Power (W) (Applicable standard IEC76-1(1976), IEEE C57.12.90-1993, IEC76-1(1993))	Pc $\Sigma$
Efficiency 1	$\eta$ : Efficiency of wiring B with respect to wiring A
Efficiency 2	1/ $\eta$ : Efficiency of wiring A with respect to wiring B

**Measurement function of the motor module**

(For details related to the determination and equations of measurement functions, see “Chapter 15.”)

Motor modules can be used on only products (PZ4000) with firmware version 2.01 or later.

Item	Symbol and Meaning
Rotating speed	Speed: Motor's rotating speed
Torque	Torque: Motor's torque
Synchronous speed	Sync
Slip	Slip
Motor output	Pm: Motor's mechanical output (mechanical power)
Motor efficiency*	$\eta_{mA}$ or $\eta_{mB}$ : Ratio of the motor output versus the power consumption of the motor
Total efficiency*	$\eta_{mA}$ or $\eta_{mB}$ : Ratio of the motor output versus the power consumed by the motor as well as the converter through which power is fed to the motor

\* The symbols  $\eta_{mA}$  and  $\eta_{mB}$  are assigned to either the motor efficiency or total efficiency depending on the circuit wiring to elements 1, 2, and 3, and the selected wiring method (A-B). For details, see section 15.8.

## 17.4 Measurement Function (Measurement Item)

### Measurement function in the harmonic measurement mode

Measurement functions that are determined for each element (power measurement module).

(For details related to the determination of and the equations of measurement functions, see “Appendix 2.”)

Item	Symbol and Meaning
Voltage (V)	$U(k)$ : rms value of the harmonic voltage of order $k$ <sup>*1</sup> , $U$ : Total rms value of the voltage signal <sup>*2</sup>
Current (A)	$I(k)$ : rms value of the harmonic current of order $k$ , $I$ : Total rms value of the current signal
Active power (W)	$P(k)$ : Active power of the harmonic signal of order $k$ , Total active power
Apparent power (VA)	$S(k)$ : Apparent power of the harmonic signal of order $k$ , $S$ : Total apparent power
Reactive power (var)	$Q(k)$ : Reactive power of the harmonic signal of order $k$ , $Q$ : Total reactive power
Power factor	$\lambda(k)$ : Power factor of the harmonic signal of order $k$ , $\lambda$ : Total power factor
Phase difference (°)	$\phi(k)$ : Phase difference between the harmonic voltage and current of order $k$ , $\phi$ : Total phase difference $\phi(k)$ : Phase difference of each harmonic voltage $U(k)$ with respect to the fundamental signal $U(1)$ $\phi I(k)$ : Phase difference of each harmonic current $I(k)$ with respect to the fundamental signal $I(1)$
Impedance ( $\Omega$ ) of the load circuit	$Z(k)$ : Impedance of the load circuit observed by the $k$ th order harmonic signal.
Resistance and reactance ( $\Omega$ ) of the load circuit	$R_s(k)$ : Resistance observed by the $k$ th order harmonic signal of the load circuit that has a resistor $R$ , inductor $L$ , and capacitor $C$ connected in series $X_s(k)$ : Reactance observed by the $k$ th order harmonic signal of the load circuit that has a resistor $R$ , inductor $L$ , and capacitor $C$ connected in series $R_p(k)$ : Resistance observed by the $k$ th order harmonic signal of the load circuit that has a resistor $R$ , inductor $L$ , and capacitor $C$ connected in parallel $X_p(k)$ : Reactance observed by the $k$ th order harmonic signal of the load circuit that has a resistor $R$ , inductor $L$ , and capacitor $C$ connected in parallel
Harmonic distortion factor [%]	$U_{hdf}(k)$ : The ratio of the harmonic voltage $U(k)$ to $U(1)$ or $U$ expressed as a percentage. $I_{hdf}(k)$ : The ratio of the harmonic current $I(k)$ to $I(1)$ or $I$ expressed as a percentage. $P_{hdf}(k)$ : The ratio of the active power $P(k)$ of the harmonic signal to $P(1)$ or $P$ expressed as a percentage.
Total harmonic distortion [%]	$U_{thd}$ : The ratio of the total harmonic voltage to $U(1)$ or $U$ <sup>*3</sup> expressed as a percentage. $I_{thd}$ : The ratio of the total harmonic current to $I(1)$ or $I$ expressed as a percentage. $P_{thd}$ : The ratio of the active power of the total harmonic signal to $P(1)$ or $P$ expressed as a percentage.
Telephone harmonic factor <sup>*4</sup> (Applicable standard IEC34-1(1996))	$U_{thf}$ : Telephone harmonic factor of voltage, $I_{thf}$ : Telephone harmonic factor of current
Telephone influence factor <sup>*4</sup> (Applicable standard IEEE Std 100(1996))	$U_{tif}$ : Telephone influence factor of voltage, $I_{tif}$ : Telephone influence factor of current
Harmonic voltage factor <sup>*4</sup> (Applicable standard IEC34-1(1996))	$h_{vf}$
Harmonic current factor <sup>*4</sup> (Determined in the same way as $h_{vf}$ )	$h_{cf}$
PLL source frequency	$f_U$ or $f_I$ . Displays the frequency of the signal selected for the PLL source. The unselected signal displays no data [-----].

\*1  $k$  is an integer in the range from 0 to the upper limit of the harmonic analysis. 0th order is the DC component. The upper limit is determined automatically (maximum is 500) by the frequency of the PLL source.

\*2 Total is a value determined according to the equation given in “Appendix 2” from the fundamental signal (1st order) and all harmonic components (2nd to the upper limit). The DC component can also be included.

\*3 Total harmonic is a value determined according to the equation given in “Appendix 2” from all harmonic components (2nd to the upper limit).

\*4 Measurement functions specific to the IEC or IEEE standard. For details, see “Appendix 2.”

**Measurement function indicating the phase difference of the fundamental voltage and current between elements 1 to 3**

Item	Symbol and Meaning
Phase difference U1-U2 (°)	$\phi_{U1-U2}$ : Phase difference of the fundamental voltage (U2(1)) of element 2 with respect to the fundamental voltage (U1(1)) of element 1.
Phase difference U1-U3 (°)	$\phi_{U1-U3}$ : Phase difference of the fundamental voltage (U3(1)) of element 3 with respect to U1(1).
Phase difference U1-I1 (°)	$\phi_{U1-I1}$ : Phase difference of the fundamental current (I1(1)) of element 1 with respect to U1(1).
Phase difference U1-I2 (°)	$\phi_{U1-I2}$ : Phase difference of the fundamental current (I2(1)) of element 2 with respect to U1(1).
Phase difference U1-I3 (°)	$\phi_{U1-I3}$ : Phase difference of the fundamental current (I3(1)) of element 3 with respect to U1(1).

**Measurement functions ( $\Sigma$ functions) that are determined for each selected wiring method (A, B)**  
**(For details related to the determination of and the equations of  $\Sigma$ functions, see “Appendix 2.”)**

Item	Symbol and Meaning
Voltage (V)	$U_{\Sigma}(k)$ : rms value of the order harmonic voltage of order $k^1$ , $U_{\Sigma}$ : Total rms value of the voltage signal <sup>*2</sup>
Current (A)	$I_{\Sigma}(k)$ : rms value of the harmonic current of order $k$ , $I_{\Sigma}$ : Total rms value of the current signal
Active power (W)	$P_{\Sigma}(k)$ : Active power of the harmonic signal of order $k$ , $P_{\Sigma}$ : Total active power
Apparent power (VA)	$S_{\Sigma}(k)$ : Apparent power of the harmonic signal of order $k$ , $S_{\Sigma}$ : Total apparent power
Reactive power (var)	$Q_{\Sigma}(k)$ : Reactive power of the harmonic signal of order $k$ , $Q_{\Sigma}$ : Total reactive power
Power factor	$\lambda_{\Sigma}(k)$ : Power factor of the harmonic signal of order $k$ , $\lambda_{\Sigma}$ : Total power factor

\*1  $k$  is an integer in the range from 0 to the upper limit of the harmonic analysis. 0th order is the DC component. The upper limit is determined automatically (maximum is 500) by the frequency of the PLL source.

\*2 Total is a value determined according to the equation given in “Appendix 2” from the fundamental signal (1st order) and all harmonic components (2nd to the upper limit). The DC component can also be included.

**Measurement function of the motor module**

**(For details related to the determination and equations of measurement functions, see “Chapter 15.”)**

Motor modules can be used on only products (PZ4000) with firmware version 2.01 or later.

Item	Symbol and Meaning
Rotating speed	Speed: Motor's rotating speed
Torque	$Trq(k)$ : Motor's torque of harmonic order $k^1$ , $U$ : Total <sup>*2</sup> torque of the motor
Synchronous speed	Sync
Slip	Slip
Motor output	$P_m$ : Motor's mechanical output (mechanical power)
Motor efficiency <sup>*3</sup>	$\eta_{mA}$ or $\eta_{mB}$ : Ratio of the motor output versus the power consumption of the motor
Total efficiency <sup>*3</sup>	$\eta_{mA}$ or $\eta_{mB}$ : Ratio of the motor output versus the power consumed by the motor as well as the converter through which power is fed to the motor

\*1  $k$  is an integer in the range from 0 to the upper limit of the harmonic analysis. 0th order is the DC component. The upper limit is determined automatically (maximum is 500) by the frequency of the PLL source.

\*2 Total is a value determined according to the equation given in “Appendix 2” from the fundamental signal (1st order) and all harmonic components (2nd to the upper limit). The DC component can also be included.

\*3 The symbols  $\eta_{mA}$  and  $\eta_{mB}$  are assigned to either the motor efficiency or total efficiency depending on the circuit wiring to elements 1, 2, and 3 and the selected wiring method (A-B). For details, see section 15.8.

## 17.5 Functions

### Measurement Mode and Wiring Method

Item	Specification
Measurement mode	Select either normal measurement or harmonic measurement mode.
Wiring method	Select one or two from 1P2W (single-phase two-wire), 1P3W (single-phase three-wire), 3P3W (three-phase three-wire), 3V3A (three-voltage, three-current), and 3P4W (three-phase four-wire).

### Motor Evaluation

This is applicable to products (PZ4000) with firmware version 2.01 or later when the motor module is installed in the element number 4 slot.

Item	Specifications
Measurement function	Speed (rotating speed), Torque, Sync (synchronous speed), Slip, Pm (motor output or mechanical power), motor efficiency, and total efficiency.

### Data Acquisition

Item	Specification
Observation time	See section 17.3, "Time Axis"
Record length	Select the record length of the acquisition memory from 100 k-word, 1 M-word (option), and 4 M-word (option).
Dividing record length	The acquisition memory can be divided in half. The sampled data can be acquired to each half.
Measurement range	Depends on the input module. See the specifications of each input module.
Scaling	Set the PT ratio, CT ratio, and power coefficient in the range from 0.0001 to 99999.9999 when applying the output from an external current sensor, PT, or CT to the instrument.
Time base	External clock can be selected. See 17.3 "Time Axis" for the specifications of the external clock.
Zero level compensation / NULL	Compensates the zero level.

### Frequency Measurement

Item	Specification
Method	Reciprocal method
Measured item	Normal measurement mode Voltage and current of all power measurement modules that are installed. Harmonic measurement mode Voltage or current that is selected for the PLL source.
Display resolution	99999
Max. display	2.5000 MHz
Accuracy	$\pm 0.1\%$ of the reading + 1 digit When the input signal is a sinusoid that has an observation time of 2 ms or more, $10 \text{ Hz} \leq f \leq 10 \text{ kHz}$ (f is the frequency), and an input level that is greater than or equal to 15% of the measurement range; there are at least 5 periods within the observation time; and the frequency of the signal being measured is less than or equal to $(1/2.5)$ of the sampling rate.
Filter for measuring frequency	Zero crossing filter



## Trigger

Item	Specification
Edge trigger	<p>Trigger mode Select from OFF, auto, auto level, normal, HF auto, and HF normal.</p> <p>Trigger source Select from CH1 to CH8, and Ext (external trigger input).</p> <p>Trigger level           <ul style="list-style-type: none"> <li>• When the trigger source is CH1 to CH8 : Set the level in terms of a percentage (<math>\pm 100\%</math>) from the center of the screen. The resolution is 0.1%.</li> <li>• When the trigger source is External trigger : CMOS level. For the specifications related to the external trigger, see "External Trigger Input" in section 17.6, "External Trigger I/O Section."</li> <li>• When the trigger source is HF auto or HF normal, the trigger level is approx. 3.5% of the measurement range.</li> </ul> </p> <p>Trigger slope Select from <math>\uparrow</math> (rising), <math>\downarrow</math> (falling), and <math>\uparrow\downarrow</math> (rising/falling).</p>
Window trigger	<p>Trigger mode Select from OFF, auto, and normal.</p> <p>Trigger source Select from CH1 to CH8.</p> <p>Window Select whether to activate the trigger when the trigger source level enters or leaves the specified window.</p>
Trigger position	Set in the range from 0 to 100% where the entire display screen represents 100%. The resolution is 1%.
Trigger delay	Set in the range from 0.0 to 1000000.0 $\mu\text{s}$ . The resolution is 0.5 $\mu\text{s}$ .

## Numerical Display

Item	Specification
Displayed items	Displays the numerical data of the measurement functions described in section 17.4.
Number of displayed digits	Select five (display resolution 99999) or six (display resolution 999999) for the maximum number of displayed digits for the numerical data. However, the displayed resolution of frequency, phase difference, and cursor measurement are 99999, 360.00, and 99999, respectively, regardless of the selection. In addition, the display resolution of maximum and minimum values (peak) is 99999.
Number of displayed items of numerical data	<p>Normal measurement mode Select from 8, 16, 42, 78, and All.</p> <p>Harmonic measurement mode 8, 16, single list, dual list, and <math>\Sigma</math> list.</p>
Scrolling of displayed items	<p>Normal measurement mode Scroll to display the numerical data of measurement functions that cannot be displayed on one screen.</p> <p>Harmonic measurement mode Scroll to display the numerical data of measurement functions that cannot be displayed on one screen. Page scrolling of single and dual lists is possible.</p>
Reset numerical data display	Reset the display order of the numerical data to default.

## Waveform Display

Item	Specification
Waveform display ON/OFF	Turn OFF CH1 to CH8 individually.
Waveform display format	1, 2, 3, and 4 split window displays are possible.
Display Interpolation of the waveform	Select dot or linear display.
Vertical zoom on the waveform	Zoom in/out vertically for each channel. Set a zoom factor in the range from 0.1 to 100.
Horizontal zoom on the waveform	Zoom in/out horizontally. The maximum zoom factor depends on the display record length and observation time (see section 9.8). Select up to two positions to be zoomed.
Graticule	Select the display of grid and scales.
Auxiliary display ON/OFF	Turn ON/OFF the upper and lower limits (scale value) and the waveform label.

## 17.5 Functions

### Vector/Bar Graph Displays

Item	Specification
Vector display	Applicable during the harmonic measurement mode. Displays vectors of the phase difference of the fundamental signals.
Bar graph display	Applicable during the harmonic measurement mode. Displays the bar graph of the amplitude of each harmonic.

### Simultaneous display

Displays a combination of two displays from numerical, waveform, and bar graph, in the top and bottom halves of the divided screen.

### Numerical computation

Item	Specification
Measurement/computation period	Set the period over which the measurement function or numerical computation is performed. Select the method from zero crossing, cursor, and external trigger and set period for each. However, cursor can only be used during the harmonic measurement mode. For the specifications on the external trigger input, see section 17.6, "External Trigger I/O Section."
Delta computation	Applicable only during the normal measurement mode. Compute other numerical data of the measured circuit from the computed results of the difference of the instantaneous values.
User-defined function	Compute numerical data of equations (up to four equations) that are created by combining the measurement function symbols and operators.
Equation for the apparent power	Applicable only during the normal measurement mode. Select the equation from $U_{rms} \times I_{rms}$ , $U_{mn} \times I_{mn}$ , and $U_{dc} \times I_{dc}$ .
Averaging	Exponential averaging. Select the attenuation constant from 2, 4, 8, 16, 32, and 64.
Phase difference display	Select whether to display using lead and lag format or 360° format.
Equation for the distortion factor	Set the denominator of the equation to the total waveform or fundamental waveform.
Corrected Power	Correction of active power as defined by the applicable standard IEC76-1(1976), IEEE C57.12.90-1993, and IEC76-1(1993).
Re-computing of numerical data	The measurement/computation region can be reset and the measurement function and equation can be recomputed (except for averaging).

### Waveform Analysis

Item	Specification
Waveform computation region	Set the region for waveform computation using the cursor. Set up to 100 k-words.
Waveform computation	Computes the waveforms of equations (up to two equations) that are created by combining the waveform symbols and operators.
Display scaling	Set and display the upper and lower limits of the computed waveform. Auto configuration is possible.
FFT	Determines and displays the power spectrum using fast Fourier Transform. Select the number of computation points from 1000, 2000, and 10000.
Cursor measurement	Place markers, horizontal and vertical cursors on the waveform and measure the values at those points. The accuracy of one sampled data point is $\pm 2\%$ of range (designed value) and does not include sampling resolution and analog bandwidth errors.
Re-computing the waveform / FFT	Reset the computation region and re-compute the waveform and FFT.

## Harmonic Measurement

Item	Specification																																													
Method	PLL synchronization method																																													
Frequency range	Fundamental frequency between 20 Hz and 6.4 kHz.																																													
Measurement function	See section 17.4 "Measurement Functions."																																													
Record length	Same as for the normal measurement mode.																																													
Number of points for the FFT	8192. Arbitrarily set the start point of analysis in the acquisition memory.																																													
FFT processing word length	32 bit																																													
Window function	Rectangular																																													
PLL source	Select the voltage or current of an element that has a power measurement module installed or an external clock input. The frequency range of the external clock when used as a PLL source is 20 Hz to 6.4 kHz. For other specifications, see section 17.3, "Time Axis." External clock operation without using the PLL is also possible. 1/4096 of the external clock frequency is the fundamental frequency.																																													
PLL source filter	zero crossing filter																																													
Antialiasing filter	Line filter																																													
Relationship between the sampling rate, window width, and harmonic order being analyzed (with hysteresis)																																														
	<table border="1"> <thead> <tr> <th>Fundamental frequency<sup>1</sup> of the PLL source f [Hz]</th> <th>Sampling rate [S/s]</th> <th>Window width (Number of cycles of the fundamental wave)</th> <th>Upper limit of harmonic order under analysis</th> <th>Maximum harmonic<sup>2</sup> order having the same accuracy as the normal measurement mode</th> </tr> </thead> <tbody> <tr> <td>20 - 40</td> <td>f × 4096</td> <td>2</td> <td>500</td> <td>50</td> </tr> <tr> <td>40 - 80</td> <td>f × 2048</td> <td>4</td> <td>500</td> <td>50</td> </tr> <tr> <td>80 - 160</td> <td>f × 1024</td> <td>8</td> <td>500</td> <td>50</td> </tr> <tr> <td>160 - 320</td> <td>f × 512</td> <td>16</td> <td>200</td> <td>25</td> </tr> <tr> <td>320 - 640</td> <td>f × 256</td> <td>32</td> <td>100</td> <td>25</td> </tr> <tr> <td>640 - 1280</td> <td>f × 128</td> <td>64</td> <td>50</td> <td>10</td> </tr> <tr> <td>1280 - 2560</td> <td>f × 64</td> <td>128</td> <td>30</td> <td>10</td> </tr> <tr> <td>2560 - 6400</td> <td>f × 32</td> <td>256</td> <td>15</td> <td>–</td> </tr> </tbody> </table>	Fundamental frequency <sup>1</sup> of the PLL source f [Hz]	Sampling rate [S/s]	Window width (Number of cycles of the fundamental wave)	Upper limit of harmonic order under analysis	Maximum harmonic <sup>2</sup> order having the same accuracy as the normal measurement mode	20 - 40	f × 4096	2	500	50	40 - 80	f × 2048	4	500	50	80 - 160	f × 1024	8	500	50	160 - 320	f × 512	16	200	25	320 - 640	f × 256	32	100	25	640 - 1280	f × 128	64	50	10	1280 - 2560	f × 64	128	30	10	2560 - 6400	f × 32	256	15	–
Fundamental frequency <sup>1</sup> of the PLL source f [Hz]	Sampling rate [S/s]	Window width (Number of cycles of the fundamental wave)	Upper limit of harmonic order under analysis	Maximum harmonic <sup>2</sup> order having the same accuracy as the normal measurement mode																																										
20 - 40	f × 4096	2	500	50																																										
40 - 80	f × 2048	4	500	50																																										
80 - 160	f × 1024	8	500	50																																										
160 - 320	f × 512	16	200	25																																										
320 - 640	f × 256	32	100	25																																										
640 - 1280	f × 128	64	50	10																																										
1280 - 2560	f × 64	128	30	10																																										
2560 - 6400	f × 32	256	15	–																																										
Accuracy <sup>2</sup>	For the accuracy corresponding to bandwidths for which the accuracy of the normal measurement mode does not apply, add $0.001 \times f \times (\text{harmonic order})\%$ of reading (designed spec), f is the frequency (kHz) of the harmonic order being measured.																																													

\*1 The items of the fundamental frequency of the PLL source have hysteresis band widths.

\*2 When the PLL source is set to a channel between CH1 and CH8. For the accuracy during the normal measurement mode, see the specifications of each input module.

## Save and Load data

Save setup parameters, waveform data, and numerical data to floppy disk or external SCSI device\*.

Load the setup parameters or waveforms from the floppy disk or external SCSI device\*.

\* SCSI is an option.

## Output Screen Image Data

Output the screen image data to the built-in printer\*, external Centronics printer, or floppy disk or external SCSI device\*.

\* Built-in printer and SCSI are options.

## 17.6 External Trigger I/O Section

Item	Specification
External trigger input (EXT TRIG IN)	Connector type : BNC connector Input level : CMOS Minimum pulse width : 1 $\mu$ s Logic : $\uparrow$ (rising edge), $\downarrow$ (falling edge), $\uparrow\downarrow$ (rising/falling edge) Trigger delay time : Within (2 $\mu$ s + 1 sampling period)
External trigger output (EXT TRIG OUT)	Connector type : BNC connector Output level : CMOS Output logic format : $\downarrow$ Negative logic Output delay time : Within (1 $\mu$ s + 1 sampling period) Output hold time : Low level 200 ns or more

For the specifications of external clock input, see section 17.3, "Time Axis."

## 17.7 Internal Floppy Disk Drive

Item	Specification
Number of drives	1
Size	3.5" floppy disk
Capacity	640 KB/720 KB/1.2 MB/1.44 MB

## 17.8 GP-IB Interface

Item	Specification
Electrical and mechanical specifications	Conforms to IEEE St'd 488-1978.
Functional specifications	SH1, AH1, T6, L4, SR1, RL1, PP0, DC1, DT0, C0
Protocol	Complies with IEEE St'd 488.2-1987.
Used code	ISO (ASCII) code
Mode	Addressable mode
Address	0 to 30
Clear remote mode	Clear remote mode using LOCAL key (except during Local Lockout).

For detailed specifications of the GP-IB interface, see the Communication Interface User's Manual (IM253710-11E).

## 17.9 Serial (RS-232) Interface

Item	Specification
Connector type	D-Sub9 pin plug
Electrical specification	Complies with EIA-574 Standard (EIA-232 (RS-232) Standard for 9 pin)
Connection format	Point to point
Communication format	Full-duplex
Synchronizing format	Start-stop asynchronous transmission
Baud rate	Select from the following rates: 1200, 2400, 4800, 9600, 19200 bps

For detailed specifications related to the serial interface, see the Communication Interface User's Manual (IM253710-11E).

## 17.10 Centronics Interface

Item	Specification
Connector type	D-Sub25 pin receptacle
Electrical specifications	Conforms to Centronics specifications.
Supported printers	ESC/P, printers that support ESC/P raster commands, BJC-80V, PCL5, LIPS3, PC-PR201

## 17.11 SCSI (Option)

Item	Specification
Standard type	SCSI (Small Computer System Interface) ANSI X3.131-1986
Connector	Half-pitch 50-pin (pin type)
Connector pin assignments	Unbalanced (single end), built-in terminator
SCSI devices that are supported*	HD drive : MS-DOS ver3.3 or later, or SCSI HD drive that can be formatted using EZ-SCSI. MO drive : 128/230/640 MB drive, MO medium uses semi-IBM format. ZIP drive PD drive

\* For further information, please contact your nearest YOKOGAWA dealer.

## 17.12 Built-in Printer (Option)

Item	Specification
Printing system	Thermal line dot method
Dot density	8 dots/mm
Paper width	112 mm
Printing width	104 mm

## 17.13 General Specifications

Item	Specification
Standard operating conditions	Ambient temperature : 23±3°C Ambient humidity : 50±10% RH Power voltage and frequency : Less than 5% of the rated voltage/frequency After performing zero level compensation after the warm-up time (at least 30 min.) has passed.
Operating conditions	Temperature : 5 to 40°C Humidity : 20 to 85% RH when not using the printer, 35 to 80% RH when using the printer.
Operating altitude	2000 m or less
Storage environment	Temperature : -25 to 60°C Humidity : 20 to 80% RH (no condensation)
Rated supply voltage	100 to 120 VAC, 200 to 240 VAC
Permitted supply voltage range	90 to 132 VAC, 180 to 264 VAC
Rated supply voltage frequency	50/60 Hz
Permitted supply voltage frequency range	48 to 63 Hz
Power consumption	200 VA (when using the printer)
Insulation resistance	Between power plug and case : 50 MΩ or more at 500 VDC
Withstanding voltage	Between power plug and case : 1500 VAC (50/60 Hz) for one minute
External dimensions (For details, see page 17-14.)	Approx. 426 mm(W) × 177 mm(H) × 450 mm(D) (when the printer cover is closed, excludes the handle and other projections.)
Weight	Main unit only (253710) : Approx. 10 kg Main unit when four power measurement modules (253752) are installed : Approx. 15 kg
Cooling method	Forced air cooling
Installation position	Horizontal (except the stand can be used). Vertical position and stacking not allowed.
Battery backup	Setup parameters and internal time clock are backed up with lithium batteries.

### Fuse

Location	Max. rated voltage	Max. rated current	Type	Standard
Power supply	250 V	6.3 A	Time lag	UL/VDE certified
SCSI board*	250 V	800 mA	Time lag	VDE/SEMKO certified

\* The user cannot replace this fuse, because it is located inside the case. If you believe the fuse is blown, contact your nearest YOKOGAWA dealer.

Item	Specification												
Accessories	Power cord : 1 piece Spare power fuse : 1 piece (Attached to the fuse holder) Cover plate: 4 pieces (Attach cover plates on unused slots using screws (see below).) Current input protective cover: 1 piece. Screw: 20 pieces (M3, length: 5mm, for fixing cover plates and current input protective covers in place). Printer roll paper : 1 roll, only provided with option /B5 Rubber feet : 2 sets User's manual : 1 piece, this manual Communication Interface User's Manual : 1 piece												
Safety standard <sup>*1</sup>	Complying standard EN61010-1 (apply for 253710, 253751, 253752) Overvoltage category (Installation category) II <sup>*2</sup> Pollution degree 2 <sup>*3</sup>												
Emission <sup>*1</sup>	<table border="0"> <tr> <td>Complying standard</td> <td> <ul style="list-style-type: none"> <li>• EN55011-Group1 Class A(apply for 253710, 253751, 253752) This product is a Class A (for industrial environment) product. Operation of this product in a residential area may cause radio interference in which case the user is required to correct the interference.</li> <li>• EN61000-3-2 (apply for 253710, 253751, 253752)</li> </ul> </td> </tr> <tr> <td>Cable requirement</td> <td> <ul style="list-style-type: none"> <li>• Measuring Input To bundle the wires between source and load for each phase and to separate the input signal wires by less than 50 mm between each phase and neutral line. Attach a ferrite core (YOKOGAWA: A1179MN) on the cable near the terminal.</li> <li>• External trigger input terminal Use a 3D2W BNC cable.*<sup>4</sup></li> <li>• Trigger output terminal Same as the above external trigger input terminal.</li> <li>• External clock input terminal Same as the above external trigger input terminal.</li> <li>• RS-232 connector Use an RS-232 shielded cable.*<sup>4</sup></li> <li>• Centronics interface connector Use a shielded cable*<sup>4</sup> for the connection.</li> <li>• SCSI connector Use a SCSI shielded cable.*<sup>4</sup></li> <li>• GPIB connector Use a GPIB shielded cable*<sup>4</sup> and attach a ferrite core (YOKOGAWA: A1179MN) on the cable near the terminal.</li> </ul> </td> </tr> <tr> <td>Tests</td> <td> <table border="0"> <tr> <td>1. Main terminal disturbance</td> <td>voltage (EN55011) class A</td> </tr> <tr> <td>2. Electromagnetic radiation</td> <td>disturbance (EN55011) class A</td> </tr> <tr> <td>3. Main terminal harmonic</td> <td>current emission (EN61000-3-2)</td> </tr> </table> </td> </tr> </table>	Complying standard	<ul style="list-style-type: none"> <li>• EN55011-Group1 Class A(apply for 253710, 253751, 253752) This product is a Class A (for industrial environment) product. Operation of this product in a residential area may cause radio interference in which case the user is required to correct the interference.</li> <li>• EN61000-3-2 (apply for 253710, 253751, 253752)</li> </ul>	Cable requirement	<ul style="list-style-type: none"> <li>• Measuring Input To bundle the wires between source and load for each phase and to separate the input signal wires by less than 50 mm between each phase and neutral line. Attach a ferrite core (YOKOGAWA: A1179MN) on the cable near the terminal.</li> <li>• External trigger input terminal Use a 3D2W BNC cable.*<sup>4</sup></li> <li>• Trigger output terminal Same as the above external trigger input terminal.</li> <li>• External clock input terminal Same as the above external trigger input terminal.</li> <li>• RS-232 connector Use an RS-232 shielded cable.*<sup>4</sup></li> <li>• Centronics interface connector Use a shielded cable*<sup>4</sup> for the connection.</li> <li>• SCSI connector Use a SCSI shielded cable.*<sup>4</sup></li> <li>• GPIB connector Use a GPIB shielded cable*<sup>4</sup> and attach a ferrite core (YOKOGAWA: A1179MN) on the cable near the terminal.</li> </ul>	Tests	<table border="0"> <tr> <td>1. Main terminal disturbance</td> <td>voltage (EN55011) class A</td> </tr> <tr> <td>2. Electromagnetic radiation</td> <td>disturbance (EN55011) class A</td> </tr> <tr> <td>3. Main terminal harmonic</td> <td>current emission (EN61000-3-2)</td> </tr> </table>	1. Main terminal disturbance	voltage (EN55011) class A	2. Electromagnetic radiation	disturbance (EN55011) class A	3. Main terminal harmonic	current emission (EN61000-3-2)
Complying standard	<ul style="list-style-type: none"> <li>• EN55011-Group1 Class A(apply for 253710, 253751, 253752) This product is a Class A (for industrial environment) product. Operation of this product in a residential area may cause radio interference in which case the user is required to correct the interference.</li> <li>• EN61000-3-2 (apply for 253710, 253751, 253752)</li> </ul>												
Cable requirement	<ul style="list-style-type: none"> <li>• Measuring Input To bundle the wires between source and load for each phase and to separate the input signal wires by less than 50 mm between each phase and neutral line. Attach a ferrite core (YOKOGAWA: A1179MN) on the cable near the terminal.</li> <li>• External trigger input terminal Use a 3D2W BNC cable.*<sup>4</sup></li> <li>• Trigger output terminal Same as the above external trigger input terminal.</li> <li>• External clock input terminal Same as the above external trigger input terminal.</li> <li>• RS-232 connector Use an RS-232 shielded cable.*<sup>4</sup></li> <li>• Centronics interface connector Use a shielded cable*<sup>4</sup> for the connection.</li> <li>• SCSI connector Use a SCSI shielded cable.*<sup>4</sup></li> <li>• GPIB connector Use a GPIB shielded cable*<sup>4</sup> and attach a ferrite core (YOKOGAWA: A1179MN) on the cable near the terminal.</li> </ul>												
Tests	<table border="0"> <tr> <td>1. Main terminal disturbance</td> <td>voltage (EN55011) class A</td> </tr> <tr> <td>2. Electromagnetic radiation</td> <td>disturbance (EN55011) class A</td> </tr> <tr> <td>3. Main terminal harmonic</td> <td>current emission (EN61000-3-2)</td> </tr> </table>	1. Main terminal disturbance	voltage (EN55011) class A	2. Electromagnetic radiation	disturbance (EN55011) class A	3. Main terminal harmonic	current emission (EN61000-3-2)						
1. Main terminal disturbance	voltage (EN55011) class A												
2. Electromagnetic radiation	disturbance (EN55011) class A												
3. Main terminal harmonic	current emission (EN61000-3-2)												
Immunity <sup>*1</sup>	<table border="0"> <tr> <td>Complying standard</td> <td>EN50082-2:1995(apply for 253710, 253751, 253752)</td> </tr> <tr> <td>Cable requirement</td> <td>Same as the above cable requirement about emission.</td> </tr> <tr> <td>Tests</td> <td> <table border="0"> <tr> <td>1. Electrostatic discharge(IEC1000-4-2) : 8 kV(air discharge), 4 kV(contact discharge)</td> </tr> <tr> <td>2. EM-field immunity (IEC1000-4-3) :80 MHz to 1 GHz, 10 V/m</td> </tr> <tr> <td>3. Electrical fast transient/burst(IEC1000-4-4) : 2 kV(AC line and voltage and current Input)</td> </tr> <tr> <td>4. HF conducted immunity (IEC1000-4-6) : 0.15 to 80 MHz, 10 Vrms</td> </tr> <tr> <td>5. Power frequency magnetic field (IEC1000-4-8) : 50 Hz, 30 A/m</td> </tr> </table> </td> </tr> </table>	Complying standard	EN50082-2:1995(apply for 253710, 253751, 253752)	Cable requirement	Same as the above cable requirement about emission.	Tests	<table border="0"> <tr> <td>1. Electrostatic discharge(IEC1000-4-2) : 8 kV(air discharge), 4 kV(contact discharge)</td> </tr> <tr> <td>2. EM-field immunity (IEC1000-4-3) :80 MHz to 1 GHz, 10 V/m</td> </tr> <tr> <td>3. Electrical fast transient/burst(IEC1000-4-4) : 2 kV(AC line and voltage and current Input)</td> </tr> <tr> <td>4. HF conducted immunity (IEC1000-4-6) : 0.15 to 80 MHz, 10 Vrms</td> </tr> <tr> <td>5. Power frequency magnetic field (IEC1000-4-8) : 50 Hz, 30 A/m</td> </tr> </table>	1. Electrostatic discharge(IEC1000-4-2) : 8 kV(air discharge), 4 kV(contact discharge)	2. EM-field immunity (IEC1000-4-3) :80 MHz to 1 GHz, 10 V/m	3. Electrical fast transient/burst(IEC1000-4-4) : 2 kV(AC line and voltage and current Input)	4. HF conducted immunity (IEC1000-4-6) : 0.15 to 80 MHz, 10 Vrms	5. Power frequency magnetic field (IEC1000-4-8) : 50 Hz, 30 A/m	
Complying standard	EN50082-2:1995(apply for 253710, 253751, 253752)												
Cable requirement	Same as the above cable requirement about emission.												
Tests	<table border="0"> <tr> <td>1. Electrostatic discharge(IEC1000-4-2) : 8 kV(air discharge), 4 kV(contact discharge)</td> </tr> <tr> <td>2. EM-field immunity (IEC1000-4-3) :80 MHz to 1 GHz, 10 V/m</td> </tr> <tr> <td>3. Electrical fast transient/burst(IEC1000-4-4) : 2 kV(AC line and voltage and current Input)</td> </tr> <tr> <td>4. HF conducted immunity (IEC1000-4-6) : 0.15 to 80 MHz, 10 Vrms</td> </tr> <tr> <td>5. Power frequency magnetic field (IEC1000-4-8) : 50 Hz, 30 A/m</td> </tr> </table>	1. Electrostatic discharge(IEC1000-4-2) : 8 kV(air discharge), 4 kV(contact discharge)	2. EM-field immunity (IEC1000-4-3) :80 MHz to 1 GHz, 10 V/m	3. Electrical fast transient/burst(IEC1000-4-4) : 2 kV(AC line and voltage and current Input)	4. HF conducted immunity (IEC1000-4-6) : 0.15 to 80 MHz, 10 Vrms	5. Power frequency magnetic field (IEC1000-4-8) : 50 Hz, 30 A/m							
1. Electrostatic discharge(IEC1000-4-2) : 8 kV(air discharge), 4 kV(contact discharge)													
2. EM-field immunity (IEC1000-4-3) :80 MHz to 1 GHz, 10 V/m													
3. Electrical fast transient/burst(IEC1000-4-4) : 2 kV(AC line and voltage and current Input)													
4. HF conducted immunity (IEC1000-4-6) : 0.15 to 80 MHz, 10 Vrms													
5. Power frequency magnetic field (IEC1000-4-8) : 50 Hz, 30 A/m													

\*1 Emission, immunity and safety standards apply to products having the CE Mark. For all other products, please contact your nearest YOKOGAWA representative as listed on the back cover of this manual.

\*2 Overvoltage Categories define transient overvoltage levels, including impulse withstand voltage levels. Overvoltage Category I: Applies to equipment supplied with electricity from a circuit containing an overvoltage control device. Overvoltage Category II: Applies to equipment supplied with electricity from fixed installations like a distribution board.

\*3 Pollution Degree: Applies to the degree of adhesion of a solid, liquid, or gas which deteriorates withstand voltage or surface resistivity. Pollution Degree 1: Applies to closed atmospheres (with no, or only dry, non-conductive pollution). Pollution Degree 2: Applies to normal indoor atmospheres (with only non-conductive pollution).

\*4 The cable length is less than 3 m.

# 17.14 External Dimensions (253710)

Unit : mm

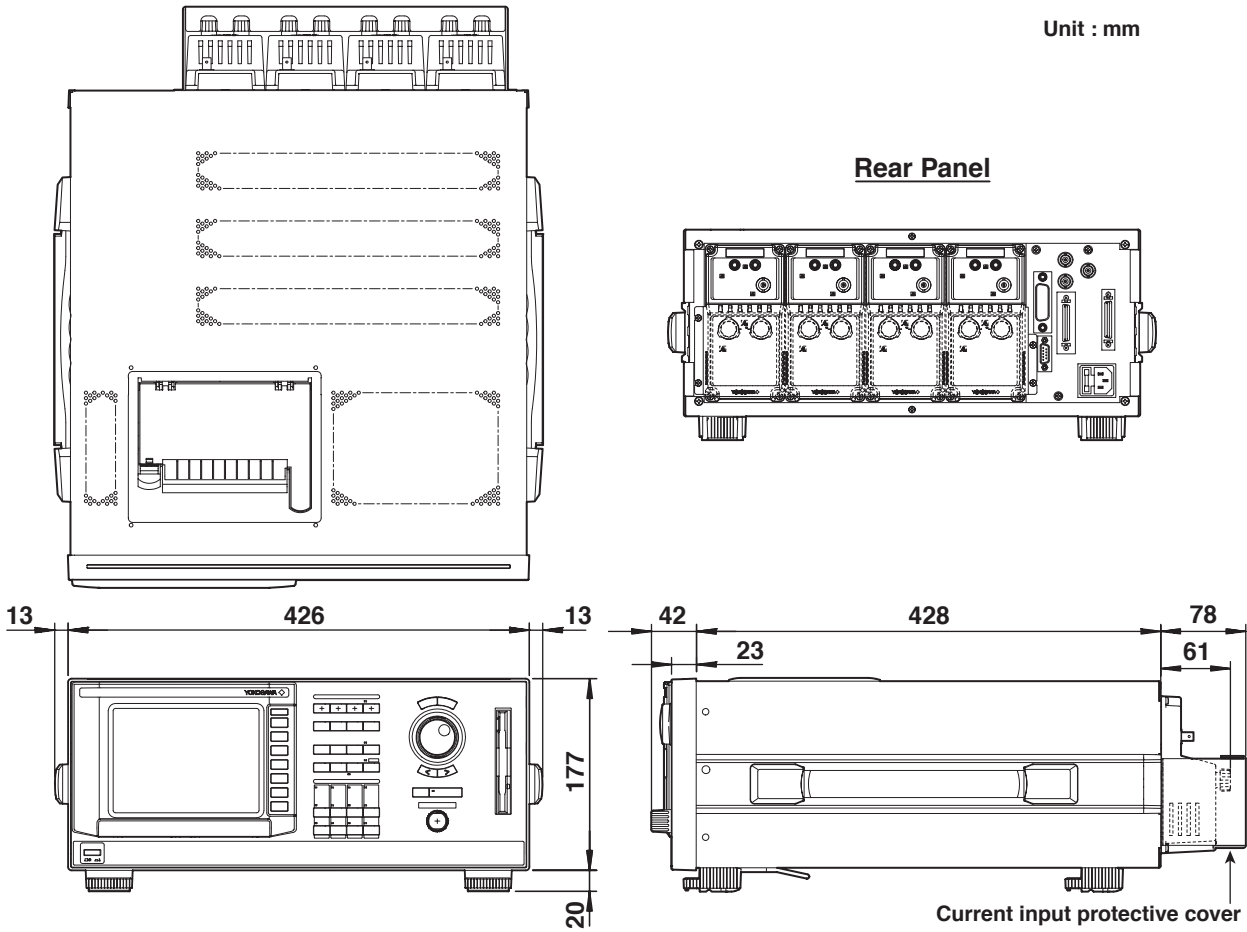

## Dimensions with the JIS rack mount kit

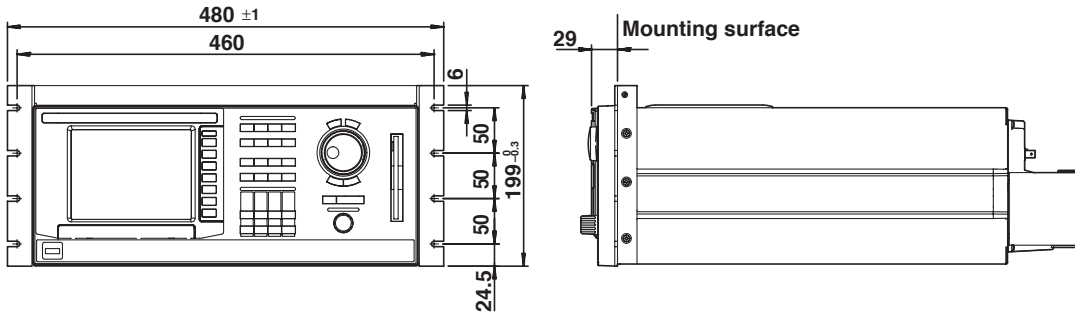

## Dimensions with the EIA rack mount kit

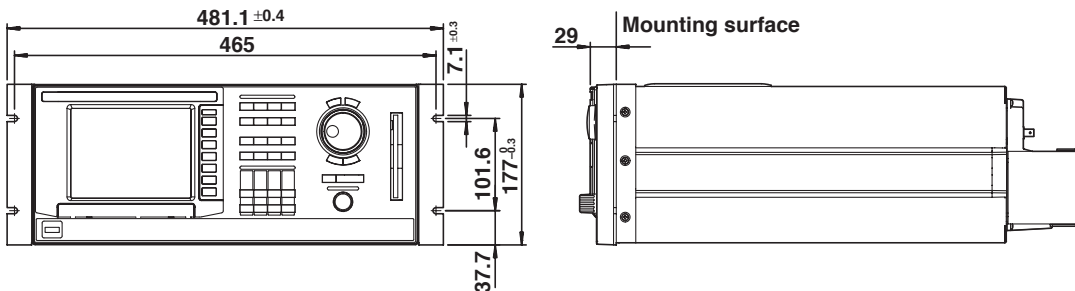

Unless otherwise specified, tolerance is ±3% (however, tolerance is ±0.3 mm when below 10 mm).



## 17.15 Power Measurement Module (253751)

Item	Specification																										
Number of input channels	2 Voltage : 1 Current : 1 (Select Direct input (5 A) terminal or current sensor input connector)																										
Insulation resistance	Between voltage input terminals and case : 50 M $\Omega$ or more at 500 VDC Between current input terminals and case : 50 M $\Omega$ or more at 500 VDC Between voltage input terminals and current input terminals : 50 M $\Omega$ or more at 500 VDC																										
Withstanding voltage	Between voltage input terminals and case : 2200 VAC (50/60 Hz) for one minute Between current input terminals and case : 2200 VAC (50/60 Hz) for one minute Between voltage input terminals and current input terminals : 3700 VAC (50/60 Hz) for one minute																										
Weight	Approx. 0.9 kg																										
Voltage input	<table border="1"> <tbody> <tr> <td>Input terminal type</td> <td>Plug-in terminal</td> </tr> <tr> <td>Input format</td> <td>Floating input, resistive voltage divider</td> </tr> <tr> <td>Input impedance</td> <td>Input resistance : Approx. 1 M<math>\Omega</math>, Input capacitance : Approx. 5 pF</td> </tr> <tr> <td>Measurement range</td> <td>Select from Auto, 2000 Vpk, 1200 Vpk, 600 Vpk, 300 Vpk, 200 Vpk, 120 Vpk, 60 Vpk, 30 Vpk.</td> </tr> <tr> <td>Frequency range</td> <td>DC to 2 MHz</td> </tr> <tr> <td>Instantaneous maximum allowable input (1 s)</td> <td>2000 Vpk or 1000 Vrms, whichever is less. (CAT II)</td> </tr> <tr> <td>Continuous maximum allowable input</td> <td>Same as the instantaneous maximum allowable input.</td> </tr> <tr> <td>Continuous maximum common mode voltage</td> <td>600 Vrms (50/60 Hz) (CAT II)</td> </tr> <tr> <td>CMRR (Influence from common mode voltage)</td> <td>Short input terminals, apply 600 Vrms (50/60 Hz) between input terminals and case. 0.005% of range or less at 10 Hz <math>\leq</math> f <math>\leq</math> 1 kHz. (Maximum range / measurement range) <math>\times</math> 0.0002 <math>\times</math> f% of range or less for other frequencies (designed value). f is the frequency in kHz.</td> </tr> <tr> <td>Line filter</td> <td>Select from OFF, 500 Hz, 20 kHz, and 1 MHz.</td> </tr> <tr> <td>Zero crossing filter</td> <td>Select from OFF, 500 Hz, and 20 kHz.</td> </tr> <tr> <td>A/D converter</td> <td>12 bit</td> </tr> <tr> <td>Sampling rate</td> <td>5 MS/s maximum</td> </tr> </tbody> </table>	Input terminal type	Plug-in terminal	Input format	Floating input, resistive voltage divider	Input impedance	Input resistance : Approx. 1 M $\Omega$ , Input capacitance : Approx. 5 pF	Measurement range	Select from Auto, 2000 Vpk, 1200 Vpk, 600 Vpk, 300 Vpk, 200 Vpk, 120 Vpk, 60 Vpk, 30 Vpk.	Frequency range	DC to 2 MHz	Instantaneous maximum allowable input (1 s)	2000 Vpk or 1000 Vrms, whichever is less. (CAT II)	Continuous maximum allowable input	Same as the instantaneous maximum allowable input.	Continuous maximum common mode voltage	600 Vrms (50/60 Hz) (CAT II)	CMRR (Influence from common mode voltage)	Short input terminals, apply 600 Vrms (50/60 Hz) between input terminals and case. 0.005% of range or less at 10 Hz $\leq$ f $\leq$ 1 kHz. (Maximum range / measurement range) $\times$ 0.0002 $\times$ f% of range or less for other frequencies (designed value). f is the frequency in kHz.	Line filter	Select from OFF, 500 Hz, 20 kHz, and 1 MHz.	Zero crossing filter	Select from OFF, 500 Hz, and 20 kHz.	A/D converter	12 bit	Sampling rate	5 MS/s maximum
Input terminal type	Plug-in terminal																										
Input format	Floating input, resistive voltage divider																										
Input impedance	Input resistance : Approx. 1 M $\Omega$ , Input capacitance : Approx. 5 pF																										
Measurement range	Select from Auto, 2000 Vpk, 1200 Vpk, 600 Vpk, 300 Vpk, 200 Vpk, 120 Vpk, 60 Vpk, 30 Vpk.																										
Frequency range	DC to 2 MHz																										
Instantaneous maximum allowable input (1 s)	2000 Vpk or 1000 Vrms, whichever is less. (CAT II)																										
Continuous maximum allowable input	Same as the instantaneous maximum allowable input.																										
Continuous maximum common mode voltage	600 Vrms (50/60 Hz) (CAT II)																										
CMRR (Influence from common mode voltage)	Short input terminals, apply 600 Vrms (50/60 Hz) between input terminals and case. 0.005% of range or less at 10 Hz $\leq$ f $\leq$ 1 kHz. (Maximum range / measurement range) $\times$ 0.0002 $\times$ f% of range or less for other frequencies (designed value). f is the frequency in kHz.																										
Line filter	Select from OFF, 500 Hz, 20 kHz, and 1 MHz.																										
Zero crossing filter	Select from OFF, 500 Hz, and 20 kHz.																										
A/D converter	12 bit																										
Sampling rate	5 MS/s maximum																										

## 17.15 Power Measurement Module (253751)

Item	Specification	
Current input		
Input terminal type	Direct input : large binding post Current sensor input : BNC connector	
Input format	Floating input, shunt input method	
Input impedance	Direct input (5 A)	Input resistance : Approx. 100 mΩ Input reactance : Approx. 0.07 μH
	Current sensor input	Input resistance : Approx. 10 kΩ
Measurement range	Direct input (5 A)	Select from Auto, 10 Apk, 4 Apk, 2 Apk, 1 Apk, 0.4 Apk, 0.2 Apk, 0.1 Apk.
	Current sensor input	Select from Auto, 1000 mVpk, 400 mVpk, 200 mVpk, 100 mVpk.
Frequency range	DC to 2 MHz	
Instantaneous maximum allowable input (1 s)	Direct input (5 A)	30 Apk or 15 Arms, whichever is less.
	Current sensor input	2 Vrms
Continuous maximum allowable input	Direct input (5 A)	10 Apk or 7 Arms, whichever is less.
	Current sensor input	2 Vrms
Continuous maximum common mode voltage	600 Vrms (50/60 Hz)	
CMRR (Influence from common mode voltage)	Open input terminals, apply 600 Vrms (50/60 Hz) between input terminals and case, f is the frequency in kHz. 0.005% of range or less at 10 Hz ≤ f ≤ 1 kHz. (Maximum range / measurement range) × 0.0002 × f% of range or less for other frequencies (designed value). f is the frequency in kHz.	
Line filter	Select from OFF, 500 Hz, 20 kHz, and 1 MHz.	
Zero crossing filter	Select from OFF, 500 Hz, and 20 kHz.	
A/D converter	12 bit	
Sampling rate	5 MS/s maximum	

Item	Specification																											
Voltage and current accuracy	Conditions <ul style="list-style-type: none"> <li>• Within 3 months after calibration</li> <li>• Standard operating conditions</li> <li>• Input signal : Sine wave</li> <li>• Common mode voltage : 0 V</li> <li>• Input signal is 5 cycles or less and there are 10 k-words of sampled data or more within the observation time.</li> <li>• DC accuracy is NULL function : ON and line filter : ON.</li> <li>• f is the frequency.</li> </ul>																											
	<table border="1"> <thead> <tr> <th>Frequency</th> <th>Accuracy</th> </tr> </thead> <tbody> <tr> <td></td> <td><math>\pm(\text{reading error} + \text{measurement range error})</math></td> </tr> <tr> <td>DC</td> <td><math>\pm(0.2\% \text{ of reading} + 0.1\% \text{ of range})</math></td> </tr> <tr> <td><math>0.1 \text{ Hz} \leq f &lt; 10 \text{ Hz}</math></td> <td><math>\pm(0.2\% \text{ of reading} + 0.1\% \text{ of range})</math></td> </tr> <tr> <td><math>10 \text{ Hz} \leq f &lt; 45 \text{ Hz}</math></td> <td><math>\pm(0.2\% \text{ of reading} + 0.05\% \text{ of range})</math></td> </tr> <tr> <td><math>45 \text{ Hz} \leq f \leq 1 \text{ kHz}</math></td> <td><math>\pm(0.1\% \text{ of reading} + 0.05\% \text{ of range})</math></td> </tr> <tr> <td><math>1 \text{ kHz} &lt; f \leq 10 \text{ kHz}</math></td> <td><math>\pm(0.1\% \text{ of reading} + 0.05\% \text{ of range})</math></td> </tr> <tr> <td><math>10 \text{ kHz} &lt; f \leq 50 \text{ kHz}</math></td> <td><math>\pm(0.2\% \text{ of reading} + 0.1\% \text{ of range})</math></td> </tr> <tr> <td><math>50 \text{ kHz} &lt; f \leq 100 \text{ kHz}</math></td> <td><math>\pm(0.6\% \text{ of reading} + 0.2\% \text{ of range})</math></td> </tr> <tr> <td><math>100 \text{ kHz} &lt; f \leq 200 \text{ kHz}</math></td> <td><math>\pm(0.6\% \text{ of reading} + 0.2\% \text{ of range})</math></td> </tr> <tr> <td><math>200 \text{ kHz} &lt; f \leq 400 \text{ kHz}</math></td> <td><math>\pm(1\% \text{ of reading} + 0.2\% \text{ of range})</math></td> </tr> <tr> <td><math>400 \text{ kHz} &lt; f \leq 500 \text{ kHz}</math></td> <td><math>\pm((0.1 + 0.006 \times f^*)\% \text{ of reading} + 0.2\% \text{ of range})</math></td> </tr> <tr> <td><math>500 \text{ kHz} &lt; f \leq 1 \text{ MHz}</math></td> <td><math>\pm((0.1 + 0.006 \times f^*)\% \text{ of reading} + 2\% \text{ of range})</math></td> </tr> <tr> <td><math>1 \text{ MHz} &lt; f \leq 5 \text{ MHz}</math></td> <td><math>\pm((0.1 + 0.006 \times f^*)\% \text{ of reading} + 2\% \text{ of range})</math></td> </tr> </tbody> </table>	Frequency	Accuracy		$\pm(\text{reading error} + \text{measurement range error})$	DC	$\pm(0.2\% \text{ of reading} + 0.1\% \text{ of range})$	$0.1 \text{ Hz} \leq f < 10 \text{ Hz}$	$\pm(0.2\% \text{ of reading} + 0.1\% \text{ of range})$	$10 \text{ Hz} \leq f < 45 \text{ Hz}$	$\pm(0.2\% \text{ of reading} + 0.05\% \text{ of range})$	$45 \text{ Hz} \leq f \leq 1 \text{ kHz}$	$\pm(0.1\% \text{ of reading} + 0.05\% \text{ of range})$	$1 \text{ kHz} < f \leq 10 \text{ kHz}$	$\pm(0.1\% \text{ of reading} + 0.05\% \text{ of range})$	$10 \text{ kHz} < f \leq 50 \text{ kHz}$	$\pm(0.2\% \text{ of reading} + 0.1\% \text{ of range})$	$50 \text{ kHz} < f \leq 100 \text{ kHz}$	$\pm(0.6\% \text{ of reading} + 0.2\% \text{ of range})$	$100 \text{ kHz} < f \leq 200 \text{ kHz}$	$\pm(0.6\% \text{ of reading} + 0.2\% \text{ of range})$	$200 \text{ kHz} < f \leq 400 \text{ kHz}$	$\pm(1\% \text{ of reading} + 0.2\% \text{ of range})$	$400 \text{ kHz} < f \leq 500 \text{ kHz}$	$\pm((0.1 + 0.006 \times f^*)\% \text{ of reading} + 0.2\% \text{ of range})$	$500 \text{ kHz} < f \leq 1 \text{ MHz}$	$\pm((0.1 + 0.006 \times f^*)\% \text{ of reading} + 2\% \text{ of range})$	$1 \text{ MHz} < f \leq 5 \text{ MHz}$
Frequency	Accuracy																											
	$\pm(\text{reading error} + \text{measurement range error})$																											
DC	$\pm(0.2\% \text{ of reading} + 0.1\% \text{ of range})$																											
$0.1 \text{ Hz} \leq f < 10 \text{ Hz}$	$\pm(0.2\% \text{ of reading} + 0.1\% \text{ of range})$																											
$10 \text{ Hz} \leq f < 45 \text{ Hz}$	$\pm(0.2\% \text{ of reading} + 0.05\% \text{ of range})$																											
$45 \text{ Hz} \leq f \leq 1 \text{ kHz}$	$\pm(0.1\% \text{ of reading} + 0.05\% \text{ of range})$																											
$1 \text{ kHz} < f \leq 10 \text{ kHz}$	$\pm(0.1\% \text{ of reading} + 0.05\% \text{ of range})$																											
$10 \text{ kHz} < f \leq 50 \text{ kHz}$	$\pm(0.2\% \text{ of reading} + 0.1\% \text{ of range})$																											
$50 \text{ kHz} < f \leq 100 \text{ kHz}$	$\pm(0.6\% \text{ of reading} + 0.2\% \text{ of range})$																											
$100 \text{ kHz} < f \leq 200 \text{ kHz}$	$\pm(0.6\% \text{ of reading} + 0.2\% \text{ of range})$																											
$200 \text{ kHz} < f \leq 400 \text{ kHz}$	$\pm(1\% \text{ of reading} + 0.2\% \text{ of range})$																											
$400 \text{ kHz} < f \leq 500 \text{ kHz}$	$\pm((0.1 + 0.006 \times f^*)\% \text{ of reading} + 0.2\% \text{ of range})$																											
$500 \text{ kHz} < f \leq 1 \text{ MHz}$	$\pm((0.1 + 0.006 \times f^*)\% \text{ of reading} + 2\% \text{ of range})$																											
$1 \text{ MHz} < f \leq 5 \text{ MHz}$	$\pm((0.1 + 0.006 \times f^*)\% \text{ of reading} + 2\% \text{ of range})$																											

\* The unit of f in the equation for the reading error is (kHz).

#### One year accuracy

$\pm(\text{reading error}) + (\text{measurement range error}) \times 1.5$ , calibration period is one year.

#### Influence from the amplitude of the input signal and frequency

For input voltages of 400 Vrms or more, add  $(\text{reading error}) \times 1.5 \times U^2\%$  of reading. For input voltages of 400 Vrms or more and frequencies of 100 kHz or more, add an additional  $0.005 \times f \times U^2\%$  of reading (designed value).

U : input voltage (kV), f : frequency (kHz)

#### Line filter influence

Add 0.5% of reading to the input signal whose frequency is 1/10th of the cut-off frequency when the line filter is ON.

#### Measurement range influence

- As shown in the above table when the input signal is a sinusoid and its rms value is between 5 and 55% of the measurement range.
- As shown in the above table when the input signal is a DC signal and the value is between -55 and 55% of the measurement range.
- The (reading error) is doubled when the input signal is a sinusoid and its rms value is between 55 and 70% of the measurement range.
- The (reading error) is doubled when the input signal is a DC signal and the value is between -100 and -55% or 55 to 100% of the measurement range.

#### Temperature coefficient

Add 0.01% of reading/ $^{\circ}\text{C}$  in the range from 5 to 20 $^{\circ}\text{C}$  or 26 to 40 $^{\circ}\text{C}$ . However, only when the input signal is 10 kHz or less.

#### Other

- Designed value for frequencies of 10 Hz or less and 1 MHz or more in the above table. (Only applicable for current sensor input and voltage input of 1 MHz or more.)
- Add designed value  $(1/10\text{th of the reading error}) \times (5 / \text{number of cycles}) \times (10 \text{ k} / \text{number of words of sampled data})\%$  of reading when the input signal contains less than 5 cycles and there are less than 10 k-words of sampled data.
- For accuracy of cursor measurements, see "Cursor Measurement" in section 17.5, "Functions."

## 17.15 Power Measurement Module (253751)

Item	Specification																										
Power accuracy	<p>Conditions</p> <ul style="list-style-type: none"> <li>• Within 3 months after calibration</li> <li>• Standard operating conditions</li> <li>• Power factor : 1</li> <li>• Input signal : Sine wave</li> <li>• Common mode voltage : 0 V</li> <li>• Input signal is 5 cycles or less and there are at least 10 k-words of sampled data within the observation time.</li> <li>• DC accuracy is NULL function : ON and line filter : ON.</li> <li>• f is the frequency.</li> </ul> <table border="1"> <thead> <tr> <th>Frequency</th> <th>Accuracy</th> </tr> </thead> <tbody> <tr> <td></td> <td><math>\pm(\text{reading error} + \text{measurement range error})</math></td> </tr> <tr> <td>DC</td> <td><math>\pm(0.2\% \text{ of reading} + 0.1\% \text{ of range})</math></td> </tr> <tr> <td><math>0.1 \text{ Hz} \leq f &lt; 10 \text{ Hz}</math></td> <td><math>\pm(0.2\% \text{ of reading} + 0.05\% \text{ of range})</math></td> </tr> <tr> <td><math>10 \text{ Hz} \leq f &lt; 45 \text{ Hz}</math></td> <td><math>\pm(0.2\% \text{ of reading} + 0.025\% \text{ of range})</math></td> </tr> <tr> <td><math>45 \text{ Hz} \leq f \leq 1 \text{ kHz}</math></td> <td><math>\pm(0.1\% \text{ of reading} + 0.025\% \text{ of range})</math></td> </tr> <tr> <td><math>1 \text{ kHz} &lt; f \leq 10 \text{ kHz}</math></td> <td><math>\pm(0.1\% \text{ of reading} + 0.04\% \text{ of range})</math></td> </tr> <tr> <td><math>10 \text{ kHz} &lt; f \leq 50 \text{ kHz}</math></td> <td><math>\pm(0.2\% \text{ of reading} + 0.05\% \text{ of range})</math></td> </tr> <tr> <td><math>50 \text{ kHz} &lt; f \leq 100 \text{ kHz}</math></td> <td><math>\pm(0.6\% \text{ of reading} + 0.1\% \text{ of range})</math></td> </tr> <tr> <td><math>100 \text{ kHz} &lt; f \leq 200 \text{ kHz}</math></td> <td><math>\pm(1.5\% \text{ of reading} + 0.15\% \text{ of range})</math></td> </tr> <tr> <td><math>200 \text{ kHz} &lt; f \leq 400 \text{ kHz}</math></td> <td><math>\pm(1.5\% \text{ of reading} + 0.15\% \text{ of range})</math></td> </tr> <tr> <td><math>400 \text{ kHz} &lt; f \leq 500 \text{ kHz}</math></td> <td><math>\pm((0.1 + 0.009 \times f^*)\% \text{ of reading} + 0.15\% \text{ of range})</math></td> </tr> <tr> <td><math>500 \text{ kHz} &lt; f \leq 1 \text{ MHz}</math></td> <td><math>\pm((0.1 + 0.009 \times f^*)\% \text{ of reading} + 1.5\% \text{ of range})</math></td> </tr> </tbody> </table>	Frequency	Accuracy		$\pm(\text{reading error} + \text{measurement range error})$	DC	$\pm(0.2\% \text{ of reading} + 0.1\% \text{ of range})$	$0.1 \text{ Hz} \leq f < 10 \text{ Hz}$	$\pm(0.2\% \text{ of reading} + 0.05\% \text{ of range})$	$10 \text{ Hz} \leq f < 45 \text{ Hz}$	$\pm(0.2\% \text{ of reading} + 0.025\% \text{ of range})$	$45 \text{ Hz} \leq f \leq 1 \text{ kHz}$	$\pm(0.1\% \text{ of reading} + 0.025\% \text{ of range})$	$1 \text{ kHz} < f \leq 10 \text{ kHz}$	$\pm(0.1\% \text{ of reading} + 0.04\% \text{ of range})$	$10 \text{ kHz} < f \leq 50 \text{ kHz}$	$\pm(0.2\% \text{ of reading} + 0.05\% \text{ of range})$	$50 \text{ kHz} < f \leq 100 \text{ kHz}$	$\pm(0.6\% \text{ of reading} + 0.1\% \text{ of range})$	$100 \text{ kHz} < f \leq 200 \text{ kHz}$	$\pm(1.5\% \text{ of reading} + 0.15\% \text{ of range})$	$200 \text{ kHz} < f \leq 400 \text{ kHz}$	$\pm(1.5\% \text{ of reading} + 0.15\% \text{ of range})$	$400 \text{ kHz} < f \leq 500 \text{ kHz}$	$\pm((0.1 + 0.009 \times f^*)\% \text{ of reading} + 0.15\% \text{ of range})$	$500 \text{ kHz} < f \leq 1 \text{ MHz}$	$\pm((0.1 + 0.009 \times f^*)\% \text{ of reading} + 1.5\% \text{ of range})$
Frequency	Accuracy																										
	$\pm(\text{reading error} + \text{measurement range error})$																										
DC	$\pm(0.2\% \text{ of reading} + 0.1\% \text{ of range})$																										
$0.1 \text{ Hz} \leq f < 10 \text{ Hz}$	$\pm(0.2\% \text{ of reading} + 0.05\% \text{ of range})$																										
$10 \text{ Hz} \leq f < 45 \text{ Hz}$	$\pm(0.2\% \text{ of reading} + 0.025\% \text{ of range})$																										
$45 \text{ Hz} \leq f \leq 1 \text{ kHz}$	$\pm(0.1\% \text{ of reading} + 0.025\% \text{ of range})$																										
$1 \text{ kHz} < f \leq 10 \text{ kHz}$	$\pm(0.1\% \text{ of reading} + 0.04\% \text{ of range})$																										
$10 \text{ kHz} < f \leq 50 \text{ kHz}$	$\pm(0.2\% \text{ of reading} + 0.05\% \text{ of range})$																										
$50 \text{ kHz} < f \leq 100 \text{ kHz}$	$\pm(0.6\% \text{ of reading} + 0.1\% \text{ of range})$																										
$100 \text{ kHz} < f \leq 200 \text{ kHz}$	$\pm(1.5\% \text{ of reading} + 0.15\% \text{ of range})$																										
$200 \text{ kHz} < f \leq 400 \text{ kHz}$	$\pm(1.5\% \text{ of reading} + 0.15\% \text{ of range})$																										
$400 \text{ kHz} < f \leq 500 \text{ kHz}$	$\pm((0.1 + 0.009 \times f^*)\% \text{ of reading} + 0.15\% \text{ of range})$																										
$500 \text{ kHz} < f \leq 1 \text{ MHz}$	$\pm((0.1 + 0.009 \times f^*)\% \text{ of reading} + 1.5\% \text{ of range})$																										

\* The unit of f in the equation for the reading error is (kHz).

### One year accuracy

$\pm((\text{reading error}) + (\text{measurement range error}) \times 1.5)$ , calibration period is one year.

### Power factor $\cos\phi$ ( $\lambda$ ) influence

- When  $\cos\phi = 0$ 
  - 45 to 66 Hz : Add (apparent power reading)  $\times 0.0015$
  - Other frequencies : Add (apparent power reading)  $\times 0.0002 \times f$  (designed value). However, add at least (apparent power reading)  $\times 0.0015$ . f is the frequency (kHz).
- When  $0 < \cos\phi < 1$ 
  - 45 to 66 Hz : Add  $(0.15 \times \tan\phi)\%$  of reading.
  - Other frequencies : Add  $(0.02 \times f \times \tan\phi)\%$  of reading (designed value). However, add at least  $(0.15 \times \tan\phi)\%$  of reading. f is the frequency (kHz).

### Influence from the amplitude of the input signal and frequency

For input voltages of 400 Vrms or more, add (reading error)  $\times 1.5 \times U^2\%$  of reading. For input voltages of 400 Vrms or more and frequencies of 100 kHz or more, add an additional  $0.005 \times f \times U^2\%$  of reading (designed value).

U : input voltage (kV), f : frequency (kHz)

### Line filter influence

Add 1% of reading to an input signal whose frequency is 1/10th of the cut-off frequency when the line filter is ON.

### Measurement range influence

- As shown in the above table when the input signal is a sinusoid and its rms value is between 5 and 55% of the measurement range.
- As shown in the above table when the input signal is a DC signal and the value is between -55 and 55% of the measurement range.
- The (reading error) is doubled when the input signal is a sinusoid and its rms value is between 55 and 70% of the measurement range.
- The (reading error) is doubled when the input signal is a DC signal and the value is between -100 and -55% or 55 to 100% of the measurement range.

(Power accuracy continues on next page)

Item	Specification
------	---------------

(Power accuracy continued)

**Temperature coefficient**

Add 0.01% of reading/°C in the range from 5 to 20°C or 26 to 40°C. However, only when the input signal is 10 kHz or less.

**Other**

- Designed value for frequencies less than or equal to 10 Hz in the table on the previous page.
- Add designed value (1/10th of the reading error) × (5 / number of cycles) × (10 k / number of words of sampled data)% of reading when the input signal contains less than 5 cycles and there are less than 10 k-words of sampled data.

External Dimensions

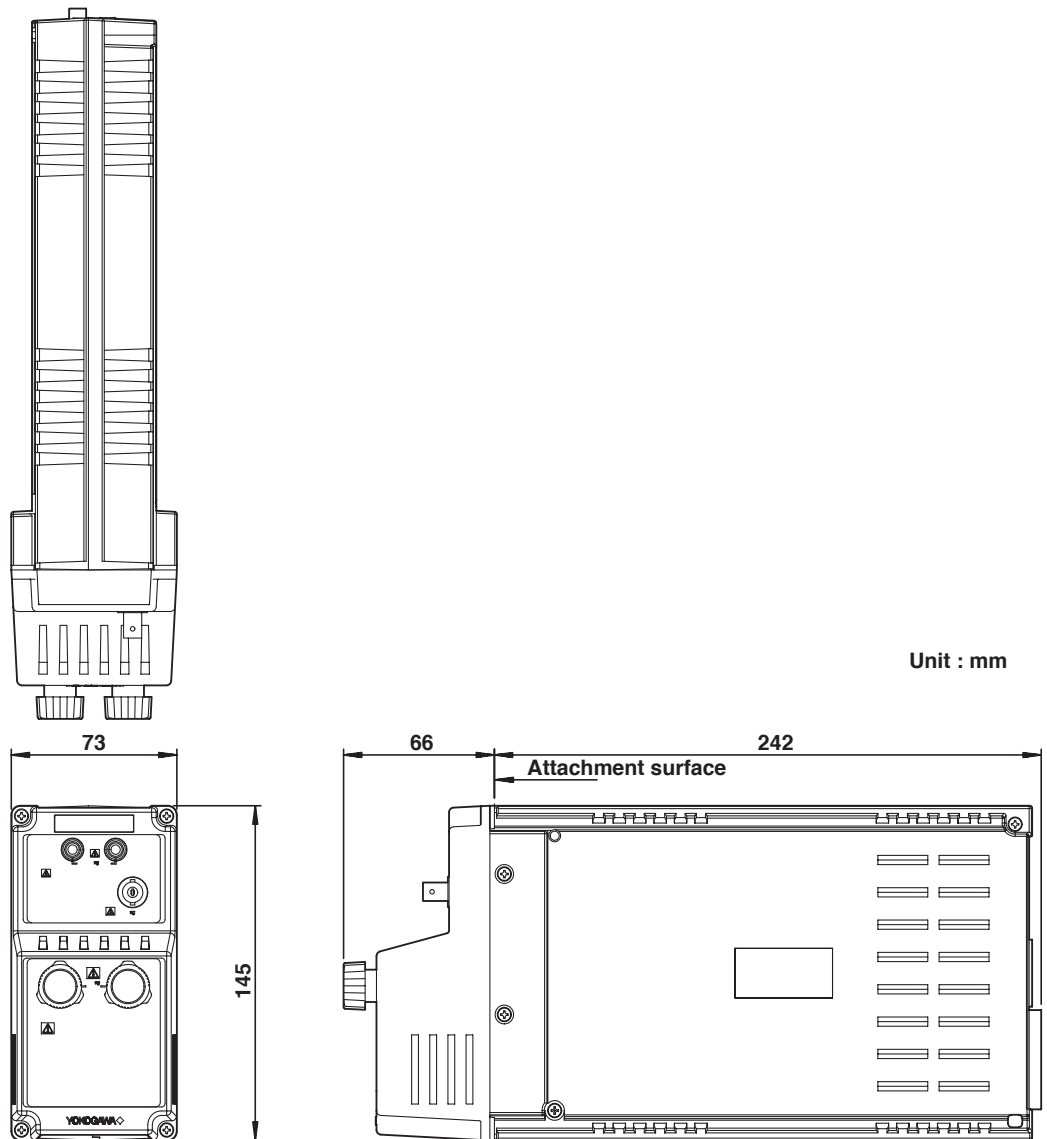

## 17.16 Power Measurement Module (253752)

Item	Specification
Number of input channels	2
	Voltage : 1 Current : 1 (Select from Direct input terminal (5 A), Direct input terminal (20 A), and current sensor input connector).
Insulation resistance	Between voltage input terminals and case : 50 M $\Omega$ or more at 500 VDC Between current input terminals and case : 50 M $\Omega$ or more at 500 VDC Between voltage input terminals and current input terminals : 50 M $\Omega$ or more at 500 VDC
Withstanding voltage	Between voltage input terminals and case : 2200 VAC (50/60 Hz) for one minute Between current input terminals and case : 2200 VAC (50/60 Hz) for one minute Between voltage input terminals and current input terminals : 3700 VAC (50/60 Hz) for one minute
Weight	Approx. 1.1 kg
Voltage input	
	Input terminal type Plug-in terminal
	Input format Floating input, resistive voltage divider
	Input impedance Input resistance : Approx. 1 M $\Omega$ , Input capacitance : Approx. 5 pF
	Measurement range Select from Auto, 2000 Vpk, 1200 Vpk, 600 Vpk, 300 Vpk, 200 Vpk, 120 Vpk, 60 Vpk, 30 Vpk.
	Frequency range DC to 2 MHz
	Instantaneous maximum allowable input (1 s) 2000 Vpk or 1000 Vrms, whichever is less. (CAT II)
	Continuous maximum allowable input Same as the instantaneous maximum allowable input.
	Continuous maximum common mode voltage 600 Vrms (50/60 Hz) (CAT II)
	CMRR (Influence from common mode voltage) Short input terminals, apply 600 Vrms (50/60 Hz) between input terminals and case. 0.005% of range or less at 10 Hz $\leq$ f $\leq$ 1 kHz. (Maximum range / measurement range) $\times$ 0.0002 $\times$ f% of range or less for other frequencies (designed value). f is the frequency in kHz.
	Line filter Select from OFF, 500 Hz, 20 kHz, and 1 MHz.
	Zero crossing filter Select from OFF, 500 Hz, and 20 kHz.
	A/D converter 12 bit
	Sampling rate 5 MS/s maximum

Item	Specification	
Current input		
Input terminal type	Direct input : large binding post Current sensor input : BNC connector	
Input format	Floating input, shunt input method	
Input impedance	Direct input (5 A)	Input resistance : Approx. 100 m $\Omega$ Input reactance : Approx. 0.07 $\mu$ H
	Direct input (20 A)	Input resistance : Approx. 11 m $\Omega$ Input reactance : Approx. 0.02 $\mu$ H
	Current sensor input	Input resistance : Approx. 10 k $\Omega$
Measurement range	Direct input (5 A)	Select from Auto, 10 Apk, 4 Apk, 2 Apk, 1 Apk, 0.4 Apk, 0.2 Apk, 0.1 Apk.
	Direct input (20 A)	Select from Auto, 100 Apk, 40 Apk, 20 Apk, 10 Apk, 4 Apk, 2 Apk, 1 Apk.
	Current sensor input	Select from Auto, 1000 mVpk, 400 mVpk, 200 mVpk, 100 mVpk.
Frequency range	DC to 2 MHz	
Instantaneous maximum allowable input (1 s)	Direct input (5 A)	30 Apk or 15 Arms, whichever is less.
	Direct input (20 A)	150 Apk or 40 Arms, whichever is less
	Current sensor input	2 Vrms
Continuous maximum allowable input	Direct input (5 A)	10 Apk or 7 Arms, whichever is less.
	Direct input (20 A)	100 Apk or 30 Arms, whichever is less.
	Current sensor input	2 Vrms
Continuous maximum common mode voltage	600 Vrms (50/60 Hz)	
CMRR (Influence from common mode voltage)	Open input terminals, apply 600 Vrms (50/60 Hz) between input terminals and case, f is the frequency in kHz. 0.005% of range or less at 10 Hz $\leq$ f $\leq$ 1 kHz. (Maximum range / measurement range) $\times$ 0.0002 $\times$ f% of range or less for other frequencies (designed value). f is the frequency in kHz.	
Line filter	Select from OFF, 500 Hz, 20 kHz, and 1 MHz.	
Zero crossing filter	Select from OFF, 500 Hz, and 20 kHz.	
A/D converter	12 bit	
Sampling rate	5 MS/s maximum	

## 17.16 Power Measurement Module (253752)

Item	Specification																												
Voltage and current accuracy	<p>Conditions</p> <ul style="list-style-type: none"> <li>• Within 3 months after calibration</li> <li>• Standard operating conditions</li> <li>• Input signal : Sine wave</li> <li>• Common mode voltage : 0 V</li> <li>• Input signal is 5 cycles or less and there are 10 k-words of sampled data or more within the observation time.</li> <li>• DC accuracy is NULL function : ON and line filter : ON.</li> <li>• f is the frequency.</li> </ul> <table border="1"> <thead> <tr> <th>Frequency</th> <th>Accuracy</th> </tr> </thead> <tbody> <tr> <td></td> <td><math>\pm(\text{reading error} + \text{measurement range error})</math></td> </tr> <tr> <td>DC</td> <td><math>\pm(0.2\% \text{ of reading} + 0.1\% \text{ of range})</math></td> </tr> <tr> <td><math>0.1 \text{ Hz} \leq f &lt; 10 \text{ Hz}</math></td> <td><math>\pm(0.2\% \text{ of reading} + 0.1\% \text{ of range})</math></td> </tr> <tr> <td><math>10 \text{ Hz} \leq f &lt; 45 \text{ Hz}</math></td> <td><math>\pm(0.2\% \text{ of reading} + 0.05\% \text{ of range})</math></td> </tr> <tr> <td><math>45 \text{ Hz} \leq f \leq 1 \text{ kHz}</math></td> <td><math>\pm(0.1\% \text{ of reading} + 0.05\% \text{ of range})</math></td> </tr> <tr> <td><math>1 \text{ kHz} &lt; f \leq 10 \text{ kHz}</math></td> <td><math>\pm(0.1\% \text{ of reading} + 0.05\% \text{ of range})</math></td> </tr> <tr> <td><math>10 \text{ kHz} &lt; f \leq 50 \text{ kHz}</math></td> <td><math>\pm(0.2\% \text{ of reading} + 0.1\% \text{ of range})</math></td> </tr> <tr> <td><math>50 \text{ kHz} &lt; f \leq 100 \text{ kHz}</math></td> <td><math>\pm(0.6\% \text{ of reading} + 0.2\% \text{ of range})</math></td> </tr> <tr> <td><math>100 \text{ kHz} &lt; f \leq 200 \text{ kHz}</math></td> <td><math>\pm(0.6\% \text{ of reading} + 0.2\% \text{ of range})</math></td> </tr> <tr> <td><math>200 \text{ kHz} &lt; f \leq 400 \text{ kHz}</math></td> <td><math>\pm(1\% \text{ of reading} + 0.2\% \text{ of range})</math></td> </tr> <tr> <td><math>400 \text{ kHz} &lt; f \leq 500 \text{ kHz}</math></td> <td><math>\pm((0.1 + 0.006 \times f^*)\% \text{ of reading} + 0.2\% \text{ of range})</math></td> </tr> <tr> <td><math>500 \text{ kHz} &lt; f \leq 1 \text{ MHz}</math></td> <td><math>\pm((0.1 + 0.006 \times f^*)\% \text{ of reading} + 2\% \text{ of range})</math></td> </tr> <tr> <td><math>1 \text{ MHz} &lt; f \leq 5 \text{ MHz}</math></td> <td><math>\pm((0.1 + 0.006 \times f^*)\% \text{ of reading} + 2\% \text{ of range})</math></td> </tr> </tbody> </table>	Frequency	Accuracy		$\pm(\text{reading error} + \text{measurement range error})$	DC	$\pm(0.2\% \text{ of reading} + 0.1\% \text{ of range})$	$0.1 \text{ Hz} \leq f < 10 \text{ Hz}$	$\pm(0.2\% \text{ of reading} + 0.1\% \text{ of range})$	$10 \text{ Hz} \leq f < 45 \text{ Hz}$	$\pm(0.2\% \text{ of reading} + 0.05\% \text{ of range})$	$45 \text{ Hz} \leq f \leq 1 \text{ kHz}$	$\pm(0.1\% \text{ of reading} + 0.05\% \text{ of range})$	$1 \text{ kHz} < f \leq 10 \text{ kHz}$	$\pm(0.1\% \text{ of reading} + 0.05\% \text{ of range})$	$10 \text{ kHz} < f \leq 50 \text{ kHz}$	$\pm(0.2\% \text{ of reading} + 0.1\% \text{ of range})$	$50 \text{ kHz} < f \leq 100 \text{ kHz}$	$\pm(0.6\% \text{ of reading} + 0.2\% \text{ of range})$	$100 \text{ kHz} < f \leq 200 \text{ kHz}$	$\pm(0.6\% \text{ of reading} + 0.2\% \text{ of range})$	$200 \text{ kHz} < f \leq 400 \text{ kHz}$	$\pm(1\% \text{ of reading} + 0.2\% \text{ of range})$	$400 \text{ kHz} < f \leq 500 \text{ kHz}$	$\pm((0.1 + 0.006 \times f^*)\% \text{ of reading} + 0.2\% \text{ of range})$	$500 \text{ kHz} < f \leq 1 \text{ MHz}$	$\pm((0.1 + 0.006 \times f^*)\% \text{ of reading} + 2\% \text{ of range})$	$1 \text{ MHz} < f \leq 5 \text{ MHz}$	$\pm((0.1 + 0.006 \times f^*)\% \text{ of reading} + 2\% \text{ of range})$
Frequency	Accuracy																												
	$\pm(\text{reading error} + \text{measurement range error})$																												
DC	$\pm(0.2\% \text{ of reading} + 0.1\% \text{ of range})$																												
$0.1 \text{ Hz} \leq f < 10 \text{ Hz}$	$\pm(0.2\% \text{ of reading} + 0.1\% \text{ of range})$																												
$10 \text{ Hz} \leq f < 45 \text{ Hz}$	$\pm(0.2\% \text{ of reading} + 0.05\% \text{ of range})$																												
$45 \text{ Hz} \leq f \leq 1 \text{ kHz}$	$\pm(0.1\% \text{ of reading} + 0.05\% \text{ of range})$																												
$1 \text{ kHz} < f \leq 10 \text{ kHz}$	$\pm(0.1\% \text{ of reading} + 0.05\% \text{ of range})$																												
$10 \text{ kHz} < f \leq 50 \text{ kHz}$	$\pm(0.2\% \text{ of reading} + 0.1\% \text{ of range})$																												
$50 \text{ kHz} < f \leq 100 \text{ kHz}$	$\pm(0.6\% \text{ of reading} + 0.2\% \text{ of range})$																												
$100 \text{ kHz} < f \leq 200 \text{ kHz}$	$\pm(0.6\% \text{ of reading} + 0.2\% \text{ of range})$																												
$200 \text{ kHz} < f \leq 400 \text{ kHz}$	$\pm(1\% \text{ of reading} + 0.2\% \text{ of range})$																												
$400 \text{ kHz} < f \leq 500 \text{ kHz}$	$\pm((0.1 + 0.006 \times f^*)\% \text{ of reading} + 0.2\% \text{ of range})$																												
$500 \text{ kHz} < f \leq 1 \text{ MHz}$	$\pm((0.1 + 0.006 \times f^*)\% \text{ of reading} + 2\% \text{ of range})$																												
$1 \text{ MHz} < f \leq 5 \text{ MHz}$	$\pm((0.1 + 0.006 \times f^*)\% \text{ of reading} + 2\% \text{ of range})$																												

\* The unit of f in the equation for the reading error is (kHz).

### One year accuracy

$\pm(\text{reading error}) + (\text{measurement range error} \times 1.5)$ , calibration period is one year.

### Influence from the amplitude of the input signal and frequency

- For input voltages of 400 Vrms or more, add  $(\text{reading error}) \times 1.5 \times U^2\%$  of reading. For input voltages of 400 Vrms or more and frequencies of 100 kHz or more, add an additional  $0.005 \times f \times U^2\%$  of reading (designed value).
  - For input currents of 10 Arms or more, add  $0.0002 \times I^2\%$  of reading.
- U : input voltage (kV), I : input current (A), f : frequency (kHz)

### Line filter influence

Add 0.5% of reading to the input signal whose frequency is 1/10th of the cut-off frequency when the line filter is ON.

### Measurement range influence

- As shown in the above table when the input signal is a sinusoid and its rms value is between 5 and 55% of the measurement range.
- As shown in the above table when the input signal is a DC signal and the value is between -55 and 55% of the measurement range.
- The (reading error) is doubled when the input signal is a sinusoid and its rms value is between 55 and 70% of the measurement range.
- The (reading error) is doubled when the input signal is a DC signal and the value is between -100 and -55% or 55 to 100% of the measurement range.

### Temperature coefficient

Add 0.01% of the reading/ $^{\circ}\text{C}$  in the range from 5 to 20 $^{\circ}\text{C}$  or 26 to 40 $^{\circ}\text{C}$ . However, only when the input signal is 10 kHz or less.

### Other

- Designed value for frequencies of 10 Hz or less and 1 MHz or more in the above table. (Only applicable for current sensor input and voltage input of 1 MHz or more.)
- Add designed value  $(1/10\text{th of the reading error}) \times (5 / \text{number of cycles}) \times (10 \text{ k} / \text{number of words of sampled data})\%$  of reading when the input signal contains less than 5 cycles and there are less than 10 k-words of sampled data.
- For accuracy of cursor measurements, see "Cursor Measurement" in section 17.5, "Functions."



Item	Specification																										
Power accuracy	<p>Conditions</p> <ul style="list-style-type: none"> <li>• Within 3 months after calibration</li> <li>• Standard operating conditions</li> <li>• Power factor : 1</li> <li>• Input signal : Sine wave</li> <li>• Common mode voltage : 0 V</li> <li>• Input signal is 5 cycles or less and there are at least 10 k-words of sampled data within the observation time.</li> <li>• DC accuracy is NULL function : ON and line filter : ON.</li> <li>• f is the frequency.</li> </ul> <table border="1"> <thead> <tr> <th>Frequency</th> <th>Accuracy</th> </tr> </thead> <tbody> <tr> <td></td> <td><math>\pm(\text{reading error} + \text{measurement range error})</math></td> </tr> <tr> <td>DC</td> <td><math>\pm(0.2\% \text{ of reading} + 0.1\% \text{ of range})</math></td> </tr> <tr> <td><math>0.1 \text{ Hz} \leq f &lt; 10 \text{ Hz}</math></td> <td><math>\pm(0.2\% \text{ of reading} + 0.05\% \text{ of range})</math></td> </tr> <tr> <td><math>10 \text{ Hz} \leq f &lt; 45 \text{ Hz}</math></td> <td><math>\pm(0.2\% \text{ of reading} + 0.025\% \text{ of range})</math></td> </tr> <tr> <td><math>45 \text{ Hz} \leq f \leq 1 \text{ kHz}</math></td> <td><math>\pm(0.1\% \text{ of reading} + 0.025\% \text{ of range})</math></td> </tr> <tr> <td><math>1 \text{ kHz} &lt; f \leq 10 \text{ kHz}</math></td> <td><math>\pm(0.1\% \text{ of reading} + 0.04\% \text{ of range})</math></td> </tr> <tr> <td><math>10 \text{ kHz} &lt; f \leq 50 \text{ kHz}</math></td> <td><math>\pm(0.2\% \text{ of reading} + 0.05\% \text{ of range})</math></td> </tr> <tr> <td><math>50 \text{ kHz} &lt; f \leq 100 \text{ kHz}</math></td> <td><math>\pm(0.6\% \text{ of reading} + 0.1\% \text{ of range})</math></td> </tr> <tr> <td><math>100 \text{ kHz} &lt; f \leq 200 \text{ kHz}</math></td> <td><math>\pm(1.5\% \text{ of reading} + 0.15\% \text{ of range})</math></td> </tr> <tr> <td><math>200 \text{ kHz} &lt; f \leq 400 \text{ kHz}</math></td> <td><math>\pm(1.5\% \text{ of reading} + 0.15\% \text{ of range})</math></td> </tr> <tr> <td><math>400 \text{ kHz} &lt; f \leq 500 \text{ kHz}</math></td> <td><math>\pm((0.1 + 0.009 \times f^*)\% \text{ of reading} + 0.15\% \text{ of range})</math></td> </tr> <tr> <td><math>500 \text{ kHz} &lt; f \leq 1 \text{ MHz}</math></td> <td><math>\pm((0.1 + 0.009 \times f^*)\% \text{ of reading} + 1.5\% \text{ of range})</math></td> </tr> </tbody> </table> <p>* The unit of f in the equation for the reading error is (kHz).</p>	Frequency	Accuracy		$\pm(\text{reading error} + \text{measurement range error})$	DC	$\pm(0.2\% \text{ of reading} + 0.1\% \text{ of range})$	$0.1 \text{ Hz} \leq f < 10 \text{ Hz}$	$\pm(0.2\% \text{ of reading} + 0.05\% \text{ of range})$	$10 \text{ Hz} \leq f < 45 \text{ Hz}$	$\pm(0.2\% \text{ of reading} + 0.025\% \text{ of range})$	$45 \text{ Hz} \leq f \leq 1 \text{ kHz}$	$\pm(0.1\% \text{ of reading} + 0.025\% \text{ of range})$	$1 \text{ kHz} < f \leq 10 \text{ kHz}$	$\pm(0.1\% \text{ of reading} + 0.04\% \text{ of range})$	$10 \text{ kHz} < f \leq 50 \text{ kHz}$	$\pm(0.2\% \text{ of reading} + 0.05\% \text{ of range})$	$50 \text{ kHz} < f \leq 100 \text{ kHz}$	$\pm(0.6\% \text{ of reading} + 0.1\% \text{ of range})$	$100 \text{ kHz} < f \leq 200 \text{ kHz}$	$\pm(1.5\% \text{ of reading} + 0.15\% \text{ of range})$	$200 \text{ kHz} < f \leq 400 \text{ kHz}$	$\pm(1.5\% \text{ of reading} + 0.15\% \text{ of range})$	$400 \text{ kHz} < f \leq 500 \text{ kHz}$	$\pm((0.1 + 0.009 \times f^*)\% \text{ of reading} + 0.15\% \text{ of range})$	$500 \text{ kHz} < f \leq 1 \text{ MHz}$	$\pm((0.1 + 0.009 \times f^*)\% \text{ of reading} + 1.5\% \text{ of range})$
Frequency	Accuracy																										
	$\pm(\text{reading error} + \text{measurement range error})$																										
DC	$\pm(0.2\% \text{ of reading} + 0.1\% \text{ of range})$																										
$0.1 \text{ Hz} \leq f < 10 \text{ Hz}$	$\pm(0.2\% \text{ of reading} + 0.05\% \text{ of range})$																										
$10 \text{ Hz} \leq f < 45 \text{ Hz}$	$\pm(0.2\% \text{ of reading} + 0.025\% \text{ of range})$																										
$45 \text{ Hz} \leq f \leq 1 \text{ kHz}$	$\pm(0.1\% \text{ of reading} + 0.025\% \text{ of range})$																										
$1 \text{ kHz} < f \leq 10 \text{ kHz}$	$\pm(0.1\% \text{ of reading} + 0.04\% \text{ of range})$																										
$10 \text{ kHz} < f \leq 50 \text{ kHz}$	$\pm(0.2\% \text{ of reading} + 0.05\% \text{ of range})$																										
$50 \text{ kHz} < f \leq 100 \text{ kHz}$	$\pm(0.6\% \text{ of reading} + 0.1\% \text{ of range})$																										
$100 \text{ kHz} < f \leq 200 \text{ kHz}$	$\pm(1.5\% \text{ of reading} + 0.15\% \text{ of range})$																										
$200 \text{ kHz} < f \leq 400 \text{ kHz}$	$\pm(1.5\% \text{ of reading} + 0.15\% \text{ of range})$																										
$400 \text{ kHz} < f \leq 500 \text{ kHz}$	$\pm((0.1 + 0.009 \times f^*)\% \text{ of reading} + 0.15\% \text{ of range})$																										
$500 \text{ kHz} < f \leq 1 \text{ MHz}$	$\pm((0.1 + 0.009 \times f^*)\% \text{ of reading} + 1.5\% \text{ of range})$																										

**One year accuracy**

$\pm(\text{reading error}) + (\text{measurement range error}) \times 1.5$ , calibration period is one year.

**Power factor  $\cos\phi$  ( $\lambda$ ) influence**

- When  $\cos\phi = 0$ 
  - 45 to 66 Hz : Add (apparent power reading)  $\times 0.0015$
  - Other frequencies : Add (apparent power reading)  $\times 0.0002 \times f$  (designed value). However, add at least (apparent power reading)  $\times 0.0015$ . f is the frequency (kHz).
- When  $0 < \cos\phi < 1$ 
  - 45 to 66 Hz : Add  $(0.15 \times \tan\phi)\%$  of reading.
  - Other frequencies : Add  $(0.02 \times f \times \tan\phi)\%$  of reading (designed value). However, add at least  $(0.15 \times \tan\phi)\%$  of reading. f is the frequency (kHz).

**Influence from the amplitude of the input signal and frequency**

- For input voltages of 400 Vrms or more, add (reading error)  $\times 1.5 \times U^2\%$  of reading. For input voltages of 400 Vrms or more and frequencies of 100 kHz or more, add an additional  $0.005 \times f \times U^2\%$  of reading (designed value).
  - For input currents of 10 Arms or more, add  $0.0002 \times I^2\%$  of reading.
- U : input voltage (kV), I : input current (A), f : frequency (kHz)

**Line filter influence**

Add 1% of reading to an input signal whose frequency is 1/10th of the cut-off frequency when the line filter is ON.

**Measurement range influence**

- As shown in the above table when the input signal is a sinusoid and its rms value is between 5 and 55% of the measurement range.
- As shown in the above table when the input signal is a DC signal and the value is between -55 and 55% of the measurement range.
- The (reading error) is doubled when the input signal is a sinusoid and its rms value is between 55 and 70% of the measurement range.
- The (reading error) is doubled when the input signal is a DC signal and the value is between -100 and -55% or 55 to 100% of the measurement range.

(Power accuracy continues on next page)

## 17.16 Power Measurement Module (253752)

Item	Specification
------	---------------

(Power accuracy continued)

**Temperature coefficient**

Add 0.01% of reading/°C in the range from 5 to 20°C or 26 to 40°C. However, only when the input signal is 10 kHz or less.

**Other**

- Designed value for frequencies less than or equal to 10 Hz in the table on the previous page.
- Add designed value (1/10th of the reading error) × (5 / number of cycles) × (10 k / number of words of sampled data)% of reading when the input signal contains less than 5 cycles and there are less than 10 k-words of sampled data.

External Dimensions

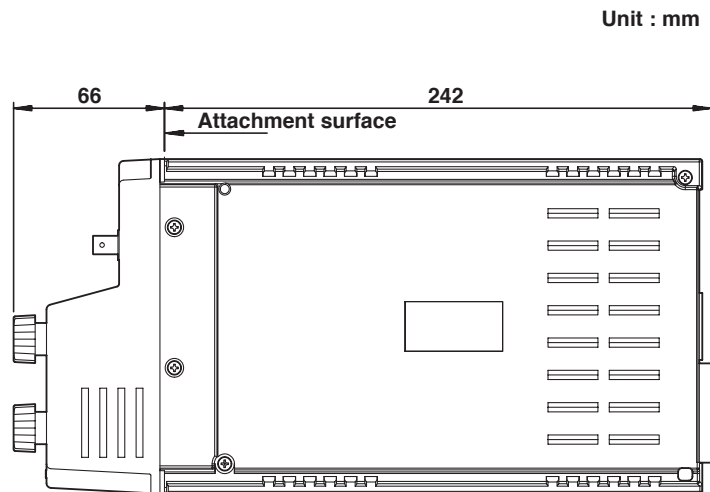
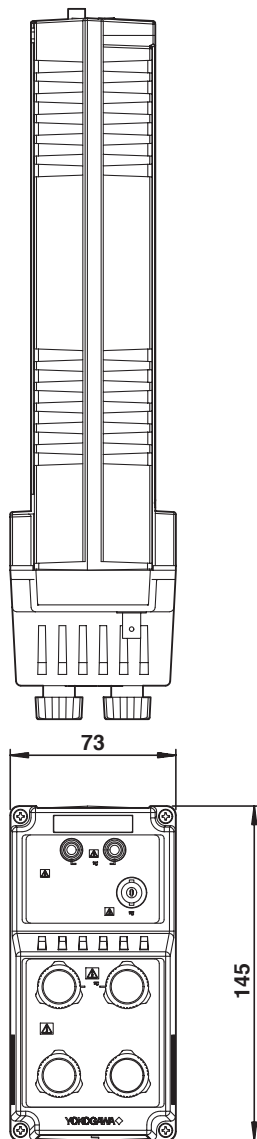

Unit : mm

## 17.17 Motor Module (253771)

Item	Specification
Connector type	BNC connector
Input format	Floating input, resistive voltage divider
Input impedance	Input resistance: Approx. 1 M $\Omega$ , Input capacitance: Approx. 17 pF
Insulation Resistance	Between voltage input terminals and case: 10 M $\Omega$ or more at 500 VDC
Withstanding voltage	Between voltage input terminals and case: 3700 VAC (50/60 Hz) for one minute
Weight	Approx. 1.1 kg
DC voltage (analog input)	
Number of input channels	2 Revolution Sensor Signal Input: 1 (CH7) Torque meter signal input: 1 (CH7)
Measurement range	Select from Auto, 50 Vpk, 20 Vpk, 10 Vpk, 5 Vpk, 2 Vpk, and 1 Vpk.
Effective input range	$\pm 100\%$ of the measurement range
Maximum allowable input	50 Vpk or 25 Vrms, whichever is less.
Continuous maximum common mode voltage	600 Vrms (50/60 Hz) (CAT II)
CMRR (Influence from common mode voltage)	Short input terminals, apply 600 Vrms (50/60 Hz) between input terminals and case. 0.005% of range or less at 10 Hz $\leq$ f $\leq$ 1 kHz. (0.025/measurement range) $\times$ % of range or less for other frequencies (designed value). f is the frequency in kHz.
Line filter	Select from OFF, 100 Hz, and 500 Hz.
Zero crossing filter	Select from OFF, 100 Hz, and 500 Hz.
A/D converter	12 bit
Sampling rate	5 MS/s maximum
Frequency band for waveform observation	DC to 500 kHz ( $-3$ dB point)
Accuracy	$\pm(0.1\%$ of reading + 0.05% of range) With NULL function and line filter turned ON. Temperature coefficient: Add 0.03% of reading/ $^{\circ}$ C in the range 5 to 20 $^{\circ}$ C or 26 to 40 $^{\circ}$ C.
Accuracy during the harmonic measurement mode (CH8)	$\pm(0.1\%$ of reading + 0.05% of range) in the range from 20 Hz to 10 kHz. The maximum applicable harmonic order is the same as when 253751 or 253752 is installed. Accuracy outside the applicable frequency range: Add $0.005 \times f \times$ (harmonic order)% of reading (designed value, f is the frequency of the relevant harmonic order (kHz)).
Pulse input	
Number of input channels	1 Revolution Sensor Signal Input: 1 (CH7)
Frequency measurement range	Auto, 2 kHz to 200 kHz, 250 Hz to 8 kHz, 16 Hz to 800 Hz, and 1 Hz to 40 Hz.
Amplitude input range	$\pm 5$ V
Effective amplitude	1 V (Peak-to-Peak) or more
Input waveform	50% duty cycle square wave
Accuracy	$\pm(0.05\%$ of reading) Except, the observation time is greater than or equal to 300 times the period of the pulse.

### 17.17 Motor Module (253771)

Item	Specification
------	---------------

External Dimensions

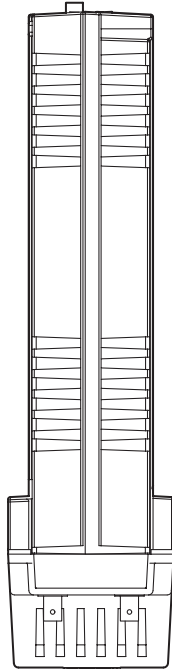

Unit : mm

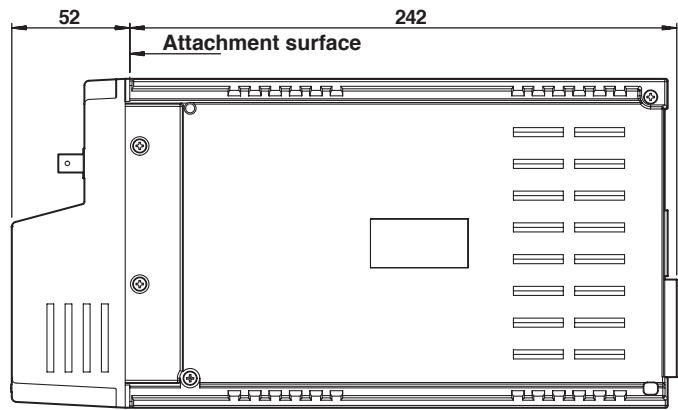
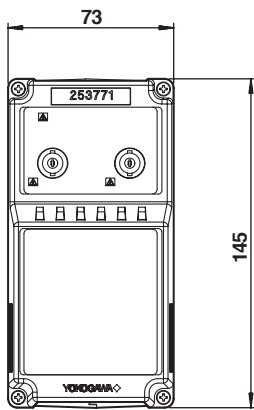

## Appendix 1 Relationship between the Observation Time, Sampling Rate, and Record length

The relationship between the observation time, sampling rate, and record length when the time base is set to internal clock are shown below. When the time base is set to external clock, the observation time is determined from the record length and the frequency of the external clock. For example, if the frequency of the external clock is 100 kHz and the record length is 100 k-words, the observation time is approximately 1 s.

### For Normal Measurement Mode

When the record length is not divided (When [Rec Division] of the Acq menu is set to [OFF])

Observation Time	Record Length					
	100 k		1 M (Option)		4 M (Option)	
	Sampling Rate (S/s)	Display Record Length (Word)	Sampling Rate (S/s)	Display Record Length (Word)	Sampling Rate (S/s)	Display Record Length (Word)
1 ks	100	100 k	1 k	1 M	4 k	4 M
400 s	250	100 k	2.5 k	1 M	10 k	4 M
200 s	500	100 k	5 k	1 M	20 k	4 M
100 s	1 k	100 k	10 k	1 M	40 k	4 M
40 s	2.5 k	100 k	25 k	1 M	100 k	4 M
20 s	5 k	100 k	50 k	1 M	200 k	4 M
10 s	10 k	100 k	100 k	1 M	250 k	2.5 M
4 s	25 k	100 k	250 k	1 M	1 M	4 M
2 s	50 k	100 k	500 k	1 M	1.25 M	2.5 M
1 s	100 k	100 k	1 M	1 M	2.5 M	2.5 M
400 ms	250 k	100 k	2.5 M	1 M	5 M	2 M
200 ms	500 k	100 k	5 M	1 M	5 M	1 M
100 ms	1 M	100 k	5 M	500 k	5 M	500 k
40 ms	2.5 M	100 k	5 M	200 k	5 M	200 k
20 ms	5 M	100 k	5 M	100 k	5 M	100 k
10 ms	5 M	50 k	5 M	50 k	5 M	50 k
4 ms	5 M	20 k	5 M	20 k	5 M	20 k
2 ms	5 M	10 k	5 M	10 k	5 M	10 k
1 ms	5 M	5 k	5 M	5 k	5 M	5 k
400 μs	5 M	2 k	5 M	2 k	5 M	2 k
200 μs	5 M	1 k	5 M	1 k	5 M	1 k
100 μs	5 M	500	5 M	500	5 M	500
40 μs	5 M	200	5 M	200	5 M	200
20 μs	5 M	100	5 M	100	5 M	100
10 μs	5 M	50	5 M	50	5 M	50

**Appendix 1 Relationship between the Observation Time, Sampling Rate, and Record length**

When the record length is divided (When [Rec Division] of the Acq menu is set to [ON])

Observation Time	Record Length					
	100 k		1 M (Option)		4 M (Option)	
	Sampling Rate (S/s)	Display Record Length (Word)	Sampling Rate (S/s)	Display Record Length (Word)	Sampling Rate (S/s)	Display Record Length (Word)
1 ks	50	50 k	500	500 k	2 k	2 M
400 s	125	50 k	1.25 k	500 k	5 k	2 M
200 s	250	50 k	2.5 k	500 k	10 k	2 M
100 s	500	50 k	5 k	500 k	20 k	2 M
40 s	1.25 k	50 k	12.5 k	500 k	50 k	2 M
20 s	2.5 k	50 k	25 k	500 k	100 k	2 M
10 s	5 k	50 k	50 k	500 k	200 k	2 M
4 s	12.5 k	50 k	125 k	500 k	500 k	2 M
2 s	25 k	50 k	250 k	500 k	1 M	2 M
1 s	50 k	50 k	500 k	500 k	1.25 M	1.25 M
400 ms	125 k	50 k	1.25 M	500 k	5 M	2 M
200 ms	250 k	50 k	2.5 M	500 k	5 M	1 M
100 ms	500 k	50 k	5 M	500 k	5 M	500 k
40 ms	1.25 M	50 k	5 M	200 k	5 M	200 k
20 ms	2.5 M	50 k	5 M	100 k	5 M	100 k
10 ms	5 M	50 k	5 M	50 k	5 M	50 k
4 ms	5 M	20 k	5 M	20 k	5 M	20 k
2 ms	5 M	10 k	5 M	10 k	5 M	10 k
1 ms	5 M	5 k	5 M	5 k	5 M	5 k
400 μs	5 M	2 k	5 M	2 k	5 M	2 k
200 μs	5 M	1 k	5 M	1 k	5 M	1 k
100 μs	5 M	500	5 M	500	5 M	500
40 μs	5 M	200	5 M	200	5 M	200
20 μs	5 M	100	5 M	100	5 M	100
10 μs	5 M	50	5 M	50	5 M	50

**For Harmonic Measurement Mode**

The record length that appears in the tables below can be selected from 100, 1 M (option), 4 M (option)

**When the record length is not divided (When [Rec Division] of the Acq menu is set to [OFF])**

Fundamental Frequency of the PLL Source f (Hz)	Sampling Rate (S/s)	Observation Time (s) Can be determined from (record length/sampling rate).		
		For 100 k-words	For 1 M-word	For 4 M-words
20 - 40	f × 4096	Approx. 0.6 to 1.6	Approx. 6.1 to 16.3	Approx. 24.4 to 65.1
40 - 80	f × 2048	Approx. 0.6 to 1.6	Approx. 6.1 to 16.3	Approx. 24.4 to 65.1
80 - 160	f × 1024	Approx. 0.6 to 1.4	Approx. 6.1 to 14.0	Approx. 24.4 to 55.8
160 - 320	f × 512	Approx. 0.6 to 1.6	Approx. 6.1 to 16.3	Approx. 24.4 to 65.1
320 - 640	f × 256	Approx. 0.6 to 1.6	Approx. 6.1 to 16.3	Approx. 24.4 to 65.1
640 - 1280	f × 128	Approx. 0.6 to 1.6	Approx. 6.1 to 16.3	Approx. 24.4 to 65.1
1280 - 2560	f × 64	Approx. 0.6 to 1.4	Approx. 6.1 to 14.2	Approx. 24.4 to 56.8
2560 - 6400	f × 32	Approx. 0.5 to 1.4	Approx. 4.9 to 14.2	Approx. 24.4 to 56.8

**When the record length is divided (When [Rec Division] of the Acq menu is set to [ON])**

Fundamental Frequency of the PLL Source f (Hz)	Sampling Rate (S/s)	Observation Time (s) Can be determined from ((record length/2)/sampling rate).		
		For 100 k-words	For 1 M-word	For 4 M-words
20 - 40	f × 4096	Approx. 0.3 to 0.8	Approx. 3.1 to 8.1	Approx. 12.2 to 32.6
40 - 80	f × 2048	Approx. 0.3 to 0.8	Approx. 3.1 to 8.1	Approx. 12.2 to 32.6
80 - 160	f × 1024	Approx. 0.3 to 0.7	Approx. 3.1 to 7.0	Approx. 12.2 to 27.9
160 - 320	f × 512	Approx. 0.3 to 0.8	Approx. 3.1 to 8.1	Approx. 12.2 to 32.6
320 - 640	f × 256	Approx. 0.3 to 0.8	Approx. 3.1 to 8.1	Approx. 12.2 to 32.6
640 - 1280	f × 128	Approx. 0.3 to 0.8	Approx. 3.1 to 8.1	Approx. 12.2 to 32.6
1280 - 2560	f × 64	Approx. 0.3 to 0.7	Approx. 3.1 to 7.1	Approx. 12.2 to 28.4
2560 - 6400	f × 32	Approx. 0.2 to 0.7	Approx. 2.4 to 7.1	Approx. 9.8 to 28.4

**Note**

The items of the fundamental frequency of the PLL source have hysteresis band widths.

# Appendix 2 Symbols and Determination of Measurement Functions

## Measurement Functions in the Normal Measurement Mode

Measurement Functions in the Normal Measurement Mode	Determination, Equation					
<b>Voltage U [V]</b> True rms value <b>Urms</b> Rectified mean value calibrated to the rms value <b>Umn</b> Simple average <b>Udc</b> AC component <b>Uac</b> Maximum <b>U+pk</b> Minimum <b>U-pk</b>	<b>Urms</b>	<b>Umn</b>	<b>Udc</b>	<b>Uac</b>	<b>U+pk</b>	<b>U-pk</b>
	$\sqrt{\frac{1}{T} \int_0^T u(t)^2 dt}$	$\frac{\pi}{2\sqrt{2}} \frac{1}{T} \int_0^T  u(t)  dt$	$\frac{1}{T} \int_0^T u(t) dt$	$\sqrt{Urms^2 - Udc^2}$	Maximum	Minimum
<b>Current I [A]</b> True rms value <b>Irms</b> Rectified mean value calibrated to the rms value <b>Imn</b> Simple average <b>Idc</b> AC component <b>Iac</b> Maximum <b>I+pk</b> Minimum <b>I-pk</b>	<b>Irms</b>	<b>Imn</b>	<b>Idc</b>	<b>Iac</b>	<b>I+pk</b>	<b>I-pk</b>
	$\sqrt{\frac{1}{T} \int_0^T i(t)^2 dt}$	$\frac{\pi}{2\sqrt{2}} \frac{1}{T} \int_0^T  i(t)  dt$	$\frac{1}{T} \int_0^T i(t) dt$	$\sqrt{Irms^2 - Idc^2}$	Maximum	Minimum
<b>fU (FreqU), fI (FreqI) [Hz]</b>	The voltage frequency ( <b>fU</b> ) and current frequency ( <b>fI</b> ) are measured using zero crossing detection.					
<b>Voltage form factor FfU</b> <b>Current form factor FfI</b>	Voltage form factor $FfU = \frac{Urms}{\frac{2\sqrt{2}}{\pi} Umn}$			Current form factor $FfI = \frac{Irms}{\frac{2\sqrt{2}}{\pi} Imn}$		
<b>Voltage crest factor CfU</b> <b>Current crest factor CfI</b>	Voltage crest factor $CfU = \frac{Upk}{Urms}$ <b>Upk = IU+pkI or IU-pkI</b> which ever is larger			Current crest factor $CfI = \frac{Ipk}{Irms}$ <b>Ipk = II+pkI or II-pkI</b> which ever is larger		
<b>Active power P [W]</b>	$\frac{1}{T} \int_0^T u(t) \cdot i(t) dt$					
<b>Apparent power S [VA]</b>	$Urms \cdot Irms$ $(Umn \cdot Imn)$ $(Udc \cdot Idc)$ Can combine rms, mn, and dc. See section 10.4.					
<b>Reactive power Q [var]</b>	$\sqrt{S^2 - P^2}$					
<b>Power factor λ</b>	$\frac{P}{S}$					
<b>Phase difference φ [°]</b>	$\cos^{-1} \left( \frac{P}{S} \right)$ The display format of the phase difference can be switched between Lead/Lag format and 360° format. See section 10.6.					
Impedance of the load circuit <b>Z [Ω]</b>	$\frac{Urms}{Irms}$					
Serial resistance of the load circuit <b>Rs [Ω]</b>	$\frac{P}{Irms^2}$					
Serial reactance of the load circuit <b>Xs [Ω]</b>	$\frac{Q}{Irms^2}$					
Parallel resistance of the load circuit <b>Rp [Ω] (=1/G)</b>	$\frac{Urms^2}{P}$					
Parallel reactance of the load circuit <b>Xp [Ω] (=1/B)</b>	$\frac{Urms^2}{Q}$					
<b>Corrected power Pc [W]</b>	IEC76-1(1976), IEEE C57.12.90-1993			IEC76-1(1993)		
	$\frac{P}{P1 + P2 \left( \frac{Urms}{Umn} \right)^2}$ P1, P2 : Coefficients as defined in the applicable standard			$P \left( 1 + \frac{Umn - Urms}{Umn} \right)$		

### Note

- The period T is determined by the measurement/computation period setting. t = 0 is the start point and t = T is the end point. For details, see section 10.1.
- u(t) and i(t) denote the sampled data of the voltage signal and the current signal, respectively.
- For information on Speed, Torque, Sync, Slip, Pm, motor efficiency, and total efficiency, see chapter 15.



Measurement Functions in the Harmonic Measurement Mode & the Motor Evaluation

(Table 1/2)

Measurement Functions in the Harmonic Measurement Mode & the Motor Evaluation	Determination, Equation			Total {No ( )}	
	The characters/values inside the ( ) of the measurement function				
	dc (When k = 0)	1 (When k = 1)	k (When k = 2 to max.)		
Voltage U( ) [V]	$U(dc) = u_r(0)$	$U(k) = \sqrt{\frac{u_r(k)^2 + u_i(k)^2}{2}}$		$U = \sqrt{\sum_{k=\min}^{\max} U(k)^2}$	
Current I( ) [A]	$I(dc) = i_r(0)$	$I(k) = \sqrt{\frac{i_r(k)^2 + i_j(k)^2}{2}}$		$I = \sqrt{\sum_{k=\min}^{\max} I(k)^2}$	
Active power P( ) [W]	$P(dc) = u_r(0) \cdot i_r(0)$	$P(k) = u_r(k) \cdot i_r(k) + u_i(k) \cdot i_j(k)$		$P = \sum_{k=\min}^{\max} P(k)$	
Apparent power S( ) [VA]	$S(dc) = P(dc)$	$S(k) = \sqrt{P(k)^2 + Q(k)^2}$		$S = \sqrt{P^2 + Q^2}$	
Reactive power Q( ) [var]	$Q(dc) = 0$	$Q(k) = u_r(k) \cdot i_j(k) - u_i(k) \cdot i_r(k)$		$Q = \sum_{k=\min}^{\max} Q(k)$	
Power factor $\lambda( )$	$\lambda(dc) = \frac{P(dc)}{S(dc)}$	$\lambda(k) = \frac{P(k)}{S(k)}$		$\lambda = \frac{P}{S}$	
Phase difference $\phi( )$ [°]	—	$\phi(k) = \cos^{-1}\left\{\frac{P(k)}{S(k)}\right\}$		$\phi = \cos^{-1}\left(\frac{P}{S}\right)$	
Phase difference with respect to U(1) $\phi_U( )$ [°]	—	—	The phase difference of U(k) with respect to $\phi_U(k) = U(1)$	—	
Phase difference with respect to I(1) $\phi_I( )$ [°]	—	—	The phase difference of I(k) with respect to $\phi_I(k) = I(1)$	—	
Impedance of the load circuit Z( ) [Ω]	$Z(dc) = \left  \frac{U(dc)}{I(dc)} \right $	$Z(k) = \left  \frac{U(k)}{I(k)} \right $		—	
Serial resistance of the load circuit Rs( ) [Ω]	$R_s(dc) = \frac{P(dc)}{I(dc)^2}$	$R_s(k) = \frac{P(k)}{I(k)^2}$		—	
Serial reactance of the load circuit Xs( ) [Ω]	$X_s(dc) = \frac{Q(dc)}{I(dc)^2}$	$X_s(k) = \frac{Q(k)}{I(k)^2}$		—	
Parallel resistance of the load circuit Rp( ) [Ω] (= 1/G)	$R_p(dc) = \frac{U(dc)^2}{P(dc)}$	$R_p(k) = \frac{U(k)^2}{P(k)}$		—	
Parallel reactance of the load circuit Xp( ) [Ω] (= 1/B)	$X_p(dc) = \frac{U(dc)^2}{Q(dc)}$	$X_p(k) = \frac{U(k)^2}{Q(k)}$		—	
Motor Evaluation	Rotating Speed Speed	—	—	Speed = Spdr(0)	
	Torque Trq( )	$Trq(dc) = trq_r(0)$	$Trq(k) = \sqrt{\frac{trq_r(k)^2 + trq_i(k)^2}{2}}$		$Trq = \sqrt{\sum_{k=\min}^{\max} Trq(k)^2}$
	Synchronous Speed Sync	—	—		Sync = $\frac{120 \cdot (f_U \text{ or } f_l)}{\text{Pole}}$
	Motor output Pm	—	—		$P_m = trq_r(0) \cdot spdr(0) \cdot \frac{2\pi}{60}$
	Slip	—	—		Slip = $\frac{\text{Sync} - \text{Speed}}{\text{Sync}}$

(Continues on the next page)

Note

- k, r, and j denote the harmonic order, real part, and imaginary part, respectively.
- min denotes the minimum order. You can select 0 (DC component) or 1 (Fundamental signal component) for the minimum order. For details, see section 10.7.
- max denotes the upper limit (see section 17.5) of the harmonic order under analysis. The upper limit is automatically determined from the frequency of the PLL source (maximum is 500).
- The numerical data of Speed, Torque, Sync, and Slip are 0th order (DC) components. The default setting of the minimum order (Min Order) in the harmonic measurement mode is 1. To display the numerical data of Speed, Torque, Sync, and Slip, the minimum order must be set to 0.
- The numerical data of Torque in the normal measurement mode are simple averaged values. The numerical data of each harmonic component and the total of Torque in the harmonic measurement mode are RMS values. The numerical data that correspond to the same value as the normal measurement mode are displayed at Trq(dc).
- The numerical data of Sync and Slip are displayed only when the PLL source (fU or fI) and frequency synchronization source (Sync Speed Source) are set to the same channel.

Appendix 2 Symbols and Determination of Measurement Functions

(Table 2/2)

Measurement Functions in the Harmonic Measurement Mode	Determination, Equation	
	The characters/values inside the ( ) of the measurement function are either dc (k = 0) or k (k = 1 to max.)	
	When the denominator of the equation for the distortion factor is Total	When the denominator of the equation for the distortion factor is Fundamental
Harmonic distortion factor of voltage <b>Uhd</b> f ( ) [%]	$\frac{U(k)}{U} \cdot 100$	$\frac{U(k)}{U(1)} \cdot 100$
Harmonic distortion factor of current <b>Ihd</b> f ( ) [%]	$\frac{I(k)}{I} \cdot 100$	$\frac{I(k)}{I(1)} \cdot 100$
Harmonic distortion factor of active power <b>Phd</b> f ( ) [%]	$\frac{P(k)}{P}$	$\frac{P(k)}{P(1)} \cdot 100$
Total harmonic distortion of voltage <b>Uthd</b> [%]	$\frac{\sqrt{\sum_{k=2}^{\max} U(k)^2}}{U} \cdot 100$	$\frac{\sqrt{\sum_{k=2}^{\max} U(k)^2}}{U(1)} \cdot 100$
Total harmonic distortion of current <b>Ithd</b> [%]	$\frac{\sqrt{\sum_{k=2}^{\max} I(k)^2}}{I} \cdot 100$	$\frac{\sqrt{\sum_{k=2}^{\max} I(k)^2}}{I(1)} \cdot 100$
Total harmonic distortion of active power <b>Pthd</b> [%]	$\left  \frac{\sum_{k=2}^{\max} P(k)}{P} \right  \cdot 100$	$\left  \frac{\sum_{k=2}^{\max} P(k)}{P(1)} \right  \cdot 100$
Telephone harmonic factor of voltage <b>Uthf</b> [%] Telephone harmonic factor of current <b>Ithf</b> [%]	$Uthf = \frac{1}{U} \sqrt{\sum_{k=1}^{\max} \{\lambda(k) \cdot U(k)\}^2} \cdot 100$	$Ithf = \frac{1}{I} \sqrt{\sum_{k=1}^{\max} \{\lambda(k) \cdot I(k)\}^2} \cdot 100$ $\lambda(k)$ : Coefficient as defined by the applicable standard (IEC34-1(1996))
Telephone influence factor of voltage <b>Utif</b> Telephone influence factor of current <b>Itif</b>	$Utif = \frac{1}{U} \sqrt{\sum_{k=1}^{\max} \{T(k) \cdot U(k)\}^2}$	$Itif = \frac{1}{I} \sqrt{\sum_{k=1}^{\max} \{T(k) \cdot I(k)\}^2}$ $T(k)$ : Coefficient as defined by the applicable standard (IEEE Std 100(1992))
Harmonic voltage factor <b>hvf</b> [%] Harmonic current factor <b>hcf</b> [%]	$hvf = \frac{1}{U} \sqrt{\sum_{k=2}^{\max} \frac{U(k)^2}{k}} \cdot 100$	$hcf = \frac{1}{I} \sqrt{\sum_{k=2}^{\max} \frac{I(k)^2}{k}} \cdot 100$
Voltage frequency <b>fU (FreqU)</b> [Hz] Current frequency <b>fI (FreqI)</b> [Hz]	Of the voltage ( <b>fU</b> ) and current ( <b>fI</b> ), the frequency of the signal that is selected as the <b>PLL</b> source is displayed. The display of the signal that is not selected shows a bar.	

**Note**

- k denotes harmonic order.
- max denotes the upper limit (see section 17.5) of the harmonic order under analysis. The upper limit is automatically determined from the frequency of the PLL source (maximum is 500).

**ΣFunction**

The table below shows the case when elements 1 and 2 or 1, 2, and 3 are configured using the wiring method in the table. If elements 2 and 3 or elements 3 and 4 are configured using the wiring method 1P3W or 3P3W in the table, replace element numbers 1 and 2 in the equation with 2 and 3 or 3 and 4, respectively. If elements 2, 3, and 4 are configured using the wiring method 3V3A or 3P3W in the table, replace 1, 2, and 3 in the equation with 2, 3, and 4.

Measurement Function (ΣFunction)	Equation			
	Single-phase, three-wire system (1P3W)	Three-phase, three-wire system (3P3W)	Three-voltage, three-current system (3V3A)	Three-voltage, four-wire system (3P4W)
For the normal measurement mode				
U [V]	UrmsΣ	(Urms1 + Urms2) / 2	(Urms1 + Urms2 + Urms3) / 3	
	UmnΣ	(Umn1 + Umn2) / 2	(Umn1 + Umn2 + Umn3) / 3	
	UdcΣ	(Udc1 + Udc2) / 2	(Udc1 + Udc2 + Udc3) / 3	
	UacΣ	(Uac1 + Uac2) / 2	(Uac1 + Uac2 + Uac3) / 3	
For the harmonic measurement mode				
	UΣ	(U1 + U2) / 2	(U1 + U2 + U3) / 3	
For the normal measurement mode				
I [A]	IrmsΣ	(Irms1 + Irms2) / 2	(Irms1 + Irms2 + Irms3) / 3	
	ImnΣ	(Imn1 + Imn2) / 2	(Imn1 + Imn2 + Imn3) / 3	
	IdcΣ	(Idc1 + Idc2) / 2	(Idc1 + Idc2 + Idc3) / 3	
	IacΣ	(Iac1 + Iac2) / 2	(Iac1 + Iac2 + Iac3) / 3	
For the harmonic measurement mode				
	IΣ	(I1 + I2) / 2	(I1 + I2 + I3) / 3	
PΣ [W]	P1 + P2			P1 + P2 + P3
For the normal measurement mode				
SΣ [VA]	S1 + S2	$\frac{\sqrt{3}}{2}(S1 + S2)$	$\frac{\sqrt{3}}{3}(S1 + S2 + S3)$	S1 + S2 + S3
	For the harmonic measurement mode			
	$\sqrt{P\Sigma^2 + Q\Sigma^2}$			
QΣ [var]	Q1 + Q2			Q1 + Q2 + Q3
λΣ	$\frac{P\Sigma}{S\Sigma}$			
φΣ [°]	$\cos^{-1}\left(\frac{P\Sigma}{S\Sigma}\right)$ (For the normal measurement mode only)			
ZΣ [Ω]	$\frac{S\Sigma}{I_{rms\Sigma}^2}$ (For the normal measurement mode only)			
RsΣ [Ω]	$\frac{P\Sigma}{I_{rms\Sigma}^2}$ (For the normal measurement mode only)			
XsΣ [Ω]	$\frac{Q\Sigma}{I_{rms\Sigma}^2}$ (For the normal measurement mode only)			
RpΣ [Ω] (= 1/G)	$\frac{U_{rms\Sigma}^2}{P\Sigma}$ (For the normal measurement mode only)			
XpΣ [Ω] (= 1/B)	$\frac{U_{rms\Sigma}^2}{Q\Sigma}$ (For the normal measurement mode only)			
PcΣ [W]	Pc1 + Pc2 (For the normal measurement mode only)			Pc1 + Pc2 + Pc3 (For the normal measurement mode only)
η (Efficiency 1) [%]	$\frac{P\Sigma B}{P\Sigma A} \cdot 100$ (For the normal measurement mode only)			
1/η (Efficiency 2) [%]	$\frac{P\Sigma A}{P\Sigma B} \cdot 100$ (For the normal measurement mode only)			

**Note**

- PΣ, QΣ, and λΣ are equations that apply both to the normal and harmonic measurement modes.
- Each symbol denotes the measurement function of the corresponding element that is determined during normal or harmonic measurement modes. For details, see section 1.2 and pages App-4 to App-6.
- The letters A and B of ΣA and ΣB denote the combinations of wiring systems. For details, see section 5.2.
- For information on Speed, Torque, Sync, Slip, Pm, motor efficiency, and total efficiency, see chapter 15.

## Appendix 3 Determination of Delta Computation

### Delta Computation Menu, Sampled Data, Symbols Used when Displaying the Computed Result

The sampled data in the table are substituted into the equations on the next page to derive the computed results.

Delta computation menu	Sampled Data that are substituted into the equations on the next page		The zero crossing source signal when the measurement/computation period is set to zero crossing detection	Symbols used when displaying the computed result	Notes
	u (t)	i (t)			
u1-u2	u1 - u2	—	Signal used to detect zero crossing points on Element 1	$\Delta U_{rms1}$ $\Delta U_{mn1}$ $\Delta U_{dc1}$ $\Delta U_{ac1}$	—
i1-i2	—	i1 - i2	Signal used to detect zero crossing points on Element 1	$\Delta I_{rms1}$ $\Delta I_{mn1}$ $\Delta I_{dc1}$ $\Delta I_{ac1}$	—
3P3W ▷3V3A	u1 - u2	- i1 - i2	Signal used to detect zero crossing points on Element 1	$\Delta U_{rms1}$ $\Delta I_{rms1}$ $\Delta U_{mn1}$ $\Delta I_{mn1}$ $\Delta U_{dc1}$ $\Delta I_{dc1}$ $\Delta U_{ac1}$ $\Delta I_{ac1}$	Presumption u1 + u2 + u3 = 0 i1 + i2 + i3 = 0
	u3 - u4	- i3 - i4	Signal used to detect zero crossing points on Element 3	$\Delta U_{rms3}$ $\Delta I_{rms3}$ $\Delta U_{mn3}$ $\Delta I_{mn3}$ $\Delta U_{dc3}$ $\Delta I_{dc3}$ $\Delta U_{ac3}$ $\Delta I_{ac3}$	
Delta ▷Star	$u1 - \frac{(u1+u2)}{3}$	—	Signal used to detect zero crossing points on Element 1	$\Delta U_{rms1}$ $\Delta U_{mn1}$ $\Delta U_{dc1}$ $\Delta U_{ac1}$	Presumption u1 + u2 + u3 = 0
	$u2 - \frac{(u1+u2)}{3}$	—		$\Delta U_{rms2}$ $\Delta U_{mn2}$ $\Delta U_{dc2}$ $\Delta U_{ac2}$	
	$-\frac{(u1+u2)}{3}$	—		$\Delta U_{rms3}$ $\Delta U_{mn3}$ $\Delta U_{dc3}$ $\Delta U_{ac3}$	
	—	i1 + i2 + i3		$\Delta I_{rms4}$ $\Delta I_{mn4}$ $\Delta I_{dc4}$ $\Delta I_{ac4}$	
Star ▷Delta	u1 - u2	—	Signal used to detect zero crossing points on Element 1	$\Delta U_{rms1}$ $\Delta U_{mn1}$ $\Delta U_{dc1}$ $\Delta U_{ac1}$	Presumption u1 + u2 + u3 = 0
	u2 - u3	—		$\Delta U_{rms2}$ $\Delta U_{mn2}$ $\Delta U_{dc2}$ $\Delta U_{ac2}$	
	u3 - u1	—		$\Delta U_{rms3}$ $\Delta U_{mn3}$ $\Delta U_{dc3}$ $\Delta U_{ac3}$	
	—	i1 + i2 + i3		$\Delta I_{rms4}$ $\Delta I_{mn4}$ $\Delta I_{dc4}$ $\Delta I_{ac4}$	

#### Note

u1, u2, u3, and u4 denote the sampled voltage data of elements 1, 2, 3, and 4, respectively.  
i1, i2, i3, and i4 denote the sampled current data of elements 1, 2, 3, and, 4, respectively.

Computed Item	Equation	Computed Item	Equation
$\Delta U_{rms}$	$\sqrt{\frac{1}{T} \int_0^T \{u(t)\}^2 dt}$	$\Delta I_{rms}$	$\sqrt{\frac{1}{T} \int_0^T \{i(t)\}^2 dt}$
$\Delta U_{mn}$	$\frac{\pi}{2\sqrt{2}} \frac{1}{T} \int_0^T  u(t)  dt$	$\Delta I_{mn}$	$\frac{\pi}{2\sqrt{2}} \frac{1}{T} \int_0^T  i(t)  dt$
$\Delta U_{dc}$	$\frac{1}{T} \int_0^T u(t) dt$	$\Delta I_{dc}$	$\frac{1}{T} \int_0^T i(t) dt$
$\Delta U_{ac}$	$\sqrt{\Delta U_{rms}^2 - \Delta U_{dc}^2}$	$\Delta I_{ac}$	$\sqrt{\Delta I_{rms}^2 - \Delta I_{dc}^2}$

**Note**

- If the sampled data used in the computation do not exist (for example, when the module is not installed), the sampled data are considered to be 0's for the computation.
- It is recommended that the measurement range and scaling (PT/CT ratio and coefficients) of the elements that are being computed (delta computation) be set the same as much as possible. Using different measurement ranges or scalings causes the measurement resolution of the sampled data to be different. In effect, the computation result will have errors.

**Delta Computation Menu/Display Position during All display**

Delta Computation Menu	Measurement Function Symbol	Display Format during All display					
		Element1	Element2	Element3	Element4	Σ A	Σ B
	----- -----	-----	-----	-----	-----	-----	-----
u1-u2	$\Delta U_{rm}$ $\Delta U_{mn}$ $\Delta U_{dc}$ $\Delta U_{ac}$	$\Delta U_{rms1}$ $\Delta U_{mn1}$ $\Delta U_{dc1}$ $\Delta U_{ac1}$	----- ----- ----- -----	----- ----- ----- -----	----- ----- ----- -----	----- ----- ----- -----	----- ----- ----- -----
i1-i2	$\Delta I_{rm}$ $\Delta I_{mn}$ $\Delta I_{dc}$ $\Delta I_{ac}$	$\Delta I_{rms1}$ $\Delta I_{mn1}$ $\Delta I_{dc1}$ $\Delta I_{ac1}$	----- ----- ----- -----	----- ----- ----- -----	----- ----- ----- -----	----- ----- ----- -----	----- ----- ----- -----
3P3W ▷3V3A	$\Delta U_{rm}$ $\Delta U_{mn}$ $\Delta U_{dc}$ $\Delta U_{ac}$ $\Delta I_{rm}$ $\Delta I_{mn}$ $\Delta I_{dc}$ $\Delta I_{ac}$	$\Delta U_{rms1}$ $\Delta U_{mn1}$ $\Delta U_{dc1}$ $\Delta U_{ac1}$ $\Delta I_{rms1}$ $\Delta I_{mn1}$ $\Delta I_{dc1}$ $\Delta I_{ac1}$	----- ----- ----- ----- ----- ----- ----- -----	$\Delta U_{rms3}$ $\Delta U_{mn3}$ $\Delta U_{dc3}$ $\Delta U_{ac3}$ $\Delta I_{rms3}$ $\Delta I_{mn3}$ $\Delta I_{dc3}$ $\Delta I_{ac3}$	----- ----- ----- ----- ----- ----- ----- -----	----- ----- ----- ----- ----- ----- ----- -----	----- ----- ----- ----- ----- ----- ----- -----
Delta ▷Star	$\Delta U_{rm}$ $\Delta U_{mn}$ $\Delta U_{dc}$ $\Delta U_{ac}$ $\Delta I_{rm}$ $\Delta I_{mn}$ $\Delta I_{dc}$ $\Delta I_{ac}$	$\Delta U_{rms1}$ $\Delta U_{mn1}$ $\Delta U_{dc1}$ $\Delta U_{ac1}$ ----- ----- ----- -----	$\Delta U_{rms2}$ $\Delta U_{mn2}$ $\Delta U_{dc2}$ $\Delta U_{ac2}$ ----- ----- ----- -----	$\Delta U_{rms3}$ $\Delta U_{mn3}$ $\Delta U_{dc3}$ $\Delta U_{ac3}$ ----- ----- ----- -----	----- ----- ----- ----- ----- $\Delta I_{rms4}$ $\Delta I_{mn4}$ $\Delta I_{dc4}$ $\Delta I_{ac4}$	----- ----- ----- ----- ----- ----- ----- -----	----- ----- ----- ----- ----- ----- ----- -----
Star ▷Delta	$\Delta U_{rm}$ $\Delta U_{mn}$ $\Delta U_{dc}$ $\Delta U_{ac}$ $\Delta I_{rm}$ $\Delta I_{mn}$ $\Delta I_{dc}$ $\Delta I_{ac}$	$\Delta U_{rms1}$ $\Delta U_{mn1}$ $\Delta U_{dc1}$ $\Delta U_{ac1}$ ----- ----- ----- -----	$\Delta U_{rms2}$ $\Delta U_{mn2}$ $\Delta U_{dc2}$ $\Delta U_{ac2}$ ----- ----- ----- -----	$\Delta U_{rms3}$ $\Delta U_{mn3}$ $\Delta U_{dc3}$ $\Delta U_{ac3}$ ----- ----- ----- -----	----- ----- ----- ----- ----- $\Delta I_{rms4}$ $\Delta I_{mn4}$ $\Delta I_{dc4}$ $\Delta I_{ac4}$	----- ----- ----- ----- ----- ----- ----- -----	----- ----- ----- ----- ----- ----- ----- -----

**Note**

During All display, the result of the delta computation is displayed at the position of each element as shown above, but the number attached to the symbol has no relation to the element number. For example, if [i1-i2] is selected from the delta computation menu, the true rms value of [i1-i2] is computed and displayed at [ $\Delta I_{rms1}$ ].

# Appendix 4 List of Initial Settings and Display Order of Numerical Data

## Initial Settings (Factory Default)

For input module 253751

Item	Setting
Setup	
Mode	Normal
Wiring	1P2W-1P2W
Display Resolution	5 digits
PLL Source	Ch1
Input	
U Range	2000Vpk
Terminal	5A
I Range	10Apk
Sensor Ratio	10.0000
Line Filter	Off
Zero Cross Filter	Off
Scaling	Off
Pt Ratio	1.0000
Ct Ratio	1.0000
Scaling Factor	1.0000
Measure(Normal)	
Mode	On
Period	Zero Cross
Sync Source	
Element1	Ch2
Element2	Ch4
Element3	Ch6
Element4	Ch8
ΔMeasure	Off
User Function	
Function1	
Mode	Off
Unit	V
Expression	URMS(E1)
Function2	
Mode	Off
Unit	A
Expression	IRMS(E1)
Function3	
Mode	Off
Unit	V
Expression	UPPK(E1)
Function4	
Mode	Off
Unit	A
Expression	IPPK(E1)
S Formula	Urms*Irms
Averaging	
Mode	Off
Count	2
Phase	180Lead/Lag
PcFormula	
Pc Formula	IEC76-1(1976)
P1	0.5000
P2	0.5000

## Appendix 4 List of Initial Settings and Display Order of Numerical Data

Item	Setting
Measure(Harmonics)	
Start Pos	0
User Function	
Function1	
Mode	Off
Unit	V
Expression	U(E1,OR1)
Function2	
Mode	Off
Unit	A
Expression	I(E1,OR1)
Function3	
Mode	Off
Unit	W
Expression	P(E1,OR1)
Function4	
Mode	Off
Unit	VA
Expression	S(E1,OR1)
Min Order	1
Max Order	100
Thd Formula	/Total
Trigger	
Mode	Off
Source	Ch1
Type	Edge
Edge	
Slope	Rise
Level	0.0%
Window	
Condition	In
Center Level	0.0%
Width Level	25.0%
Position	0%
Delay	0.0us
Display	
Format	Numeric+Wave
Item Amount	8
Numeric Disp Items	
Norm Item No.	1
Function	Urms
Element	1
Wave Setting	
Wave Format	Single
Interpolate	Line
Graticule	Grid (■)
Scale Value	On
Trace Label	Off
Mapping	Auto
Bar	
Bar Item No.	1
Function	U
Element	1
Bar Marker1	1 order
Bar Marker2	13 order
Start Order	0
End Order	100
Vector	
Numeric	On

## Appendix 4 List of Initial Settings and Display Order of Numerical Data

Item	Setting
Math	
Mode	Off
Math1	
Function	Off
Expression	C1
Unit	V
Scaling	Auto
Upper	1.0000E+2
Lower	-1.0000E+2
Math2	
Function	Off
Expression	C2
Unit	A
Scaling	Auto
Upper	1.0000E+2
Lower	-1.0000E+2
Start Point	0.000ms
End Point	100.000ms
FFT Points	1000
FFT Window	Rect
Cursor	
Type	Off
Cursor1 Trace	Ch1
Cursor2 Trace	Ch1
Zoom	
Mode	Main
Zoom Format	Main
Allocation	All On
Z1	
Z1 Mag	×2.5
Z1 Position	25.000ms
Z2	
Z2 Mag	×2.5
Z2 Position	75.000ms



**Appendix 4 List of Initial Settings and Display Order of Numerical Data**

**For input module 253752 (Only the input setting items are listed. All other items are the same as for input module 253751.)**

Item	Setting
Input	
U Range	2000Vpk
Terminal	5A
I Range	10Apk
Sensor Ratio	10.0000
Line Filter	Off
Zero Cross Filter	Off
Scaling	Off
Pt Ratio	1.0000
Ct Ratio	1.0000
Scaling Factor	1.0000

**For motor module 253771 (Only the input setting items are listed. All other items are the same as for input module 253751.)**

Item	Setting
INPUT	
Range	
Speed(Ch7)	50Vpk
Torque(Ch8)	50Vpk
Sense Type	Analog
Frequency Range	2k-200kHz
Line Filter	Off
ZeroCross Filter	Off
Scaling	
Speed (Ch7)	1.0000
Torque(Ch8)	1.0000
Pm	1.0000
Unit	
Speed(Ch7)	rpm
Torque(Ch8)	Nm
Pm	W
Pulse N	60
Pole	2
Sync Speed Source	CH2

**Items that are not reset to their factory default settings when the instrument is initialized**

**(These items are saved as setup parameters. However, they do not change the instrument's settings when loaded.)**

Item	Setting
Communication	
GPIB	
Address	1
RS232	
Baud Rate	19200
Format	8-No-1
Rx-Tx	No-No
Terminator	Cr+Lf
SCSI ID	
Own ID	6
Date/Time	The time of shipment
Message	English
LCD Brightness	2
File	
File Item	Setup
Wave	
Type	Binay
Range	All
Copy	
Copy To	Printer

### Display Order of the Numerical Data

- When the order of the numerical data is reset, the measurement function data are displayed in the order given in the next table.
- The measurement function data of element 1, 2, 3, 4,  $\Sigma A$ ,  $\Sigma B$  are displayed in that order.

#### For the normal measurement mode

Order	Measurement Function	Element
1	Urms	1
2	Umn(mean)	1
3	Udc	1
4	Uac	1
5	Irms	1
6	Imn(mean)	1
7	Idc	1
8	Iac	1
9	P	1
10	S	1
11	Q	1
12	$\lambda$	1
13	$\phi$	1
14	fU(FreqU)	1
15	fl(Freql)	1
16	U+pk	1
17	U-pk	1
18	I+pk	1
19	I-pk	1
20	CfU	1
21	Cfl	1
22	FfU	1
23	Ffl	1
24	Z	1
25	Rs	1
26	Xs	1
27	Rp	1
28	Xp	1
29	Pc	1
30	$\eta^*$	1
31	$1/\eta^*$	1
32	F1*	1
33	F2*	1
34	F3*	1
35	F4*	1
36	$\Delta Urms$	1
37	$\Delta Umn(mean)$	1
38	$\Delta Udc$	1
39	$\Delta Uac$	1
40	$\Delta Irms$	1
41	$\Delta Imn(mean)$	1
42	$\Delta Idc$	1
43	$\Delta Iac$	1
44 to 50	-----	-----

\* Displayed only for element 1.

The following data are displayed when the motor module is installed.

Order	Measurement Function	Element
44	Speed	1
45	Torque	1
46	Sync	1
47	Slip	1
48	Pm	1
49	$\eta mA$	1
50	$\eta mB$	1

**For the harmonic measurement mode**

Order	Measurement Function	Element	Harmonic Order <sup>*1</sup>
1	U	1	Total
2	I	1	Total
3	P	1	Total
4	S	1	Total
5	Q	1	Total
6	U	1	1
7	I	1	1
8	P	1	1
9	S	1	1
10	Q	1	1
11	$\lambda$	1	1
12	$\phi$	1	1
13	$\phi U$	1	1
14	$\phi I$	1	1
15	fU	1	1
16	fI	1	1
17	Z	1	1
18	Rs	1	1
19	Xs	1	1
20	Rp	1	1
21	Xp	1	1
22	Uhdf	1	1
23	Ihdf	1	1
24	Phdf	1	1
25	Uthd	1	1
26	Ithd	1	1
27	Pthd	1	1
28	Uthf	1	1
29	Ithf	1	1
30	Utif	1	1
31	Itif	1	1
32	hvf	1	1
33	hcf	1	1
34	$\phi U1-U2^{*2}$	1	1
35	$\phi U1-U3^{*2}$	1	1
36	$\phi U1-I1^{*2}$	1	1
37	$\phi U1-I2^{*2}$	1	1
38	$\phi U1-I3^{*2}$	1	1
39	F1 <sup>*2</sup>	1	1
40	F2 <sup>*2</sup>	1	1
41	F3 <sup>*2</sup>	1	1
42	F4 <sup>*2</sup>	1	1
43 to 50	-----	-----	-----

\*1 Harmonic orders are displayed inside parentheses.

\*2 Displayed only for element 1.

The following data are displayed when the motor module is installed.

Order	Measurement Function	Element	Harmonic Order
43	Speed	1	0(dc)
44	Trq(dc)	1	0(dc)
45	Sync	1	0(dc)
46	Slip	1	0(dc)
47	Pm	1	0(dc)
48	$\eta mA$	1	0(dc)
49	$\eta mB$	1	0(dc)

## Appendix 5 ASCII Header File Format

//YOKOGAWA ASCII FILE FORMAT

\$PublicInfo

FormatVersion 1.11  
Model PZ4000  
Endian Big  
DataFormat Trace  
GroupNumber 4  
TraceTotalNumber 16  
DataOffset 0

\$Group1

TraceNumber	4			
BlockNumber	1			
TraceName	Ch1	Ch2	Ch3	Ch4
BlockSize	500	500	500	500
VResolution	4.5777764E-03	3.8148137E-04	7.6296274E-02	3.8148137E-04
VOffset	3.3738281E+00	8.2995603E-02	2.5000000E+03	1.2500000E+01
VDataType	IS2	IS2	IS2	IS2
VUnit	V	A	V	A
VPlusOverData	?	?	?	?
VMinusOverData	?	?	?	?
VIllegalData	?	?	?	?
VMaxData	32767	32767	32767	32767
VMinData	-32768	-32768	-32768	-32768
HResolution	2.0000000E-07	2.0000000E-07	2.0000000E-07	2.0000000E-07
HOffset	0.0000000E+00	0.0000000E+00	0.0000000E+00	0.0000000E+00
HUnit	s	s	s	s
Date	1999/01/03	1999/01/03	1999/01/03	1999/01/03
Time	20:36:59	20:36:59	20:36:59	20:36:59

\$Group2

TraceNumber	4			
BlockNumber	1			
TraceName	Ch5	Ch6	Ch7	Ch8
BlockSize	500	500	500	500
VResolution	7.6296274E-02	3.8148137E-04	7.6296274E-02	3.8148137E-04
VOffset	2.5000000E+03	1.2500000E+01	2.5000000E+03	1.2500000E+01
VDataType	IS2	IS2	IS2	IS2
VUnit	V	A	V	A
VPlusOverData	?	?	?	?
VMinusOverData	?	?	?	?
VIllegalData	?	?	?	?
VMaxData	32767	32767	32767	32767
VMinData	-32768	-32768	-32768	-32768
HResolution	2.0000000E-07	2.0000000E-07	2.0000000E-07	2.0000000E-07
HOffset	0.0000000E+00	0.0000000E+00	0.0000000E+00	0.0000000E+00
HUnit	s	s	s	s

Date	1999/01/03	1999/01/03	1999/01/03	1999/01/03
Time	20:36:59	20:36:59	20:36:59	20:36:59
\$Group3				
TraceNumber	4			
BlockNumber	1			
TraceName	Ch1(CAL)	Ch2(CAL)	Ch3(CAL)	Ch4(CAL)
BlockSize	1024	1024	1024	1024
VResolution	4.5777764E-03	3.8148137E-04	7.6296274E-02	3.8148137E-04
VOffset	0.0000000E+00	0.0000000E+00	0.0000000E+00	0.0000000E+00
VDataType	IS2	IS2	IS2	IS2
VUnit	V	A	V	A
VPlusOverData	?	?	?	?
VMinusOverData	?	?	?	?
VIllegalData	?	?	?	?
VMaxData	32767	32767	32767	32767
VMinData	-32768	-32768	-32768	-32768
HResolution	1.0000000E-06	1.0000000E-06	1.0000000E-06	1.0000000E-06
HOffset	0.0000000E+00	0.0000000E+00	0.0000000E+00	0.0000000E+00
HUnit	s	s	s	s
Date	1999/01/03	1999/01/03	1999/01/03	1999/01/03
Time	20:36:59	20:36:59	20:36:59	20:36:59
\$Group4				
TraceNumber	4			
BlockNumber	1			
TraceName	Ch5(CAL)	Ch6(CAL)	Ch7(CAL)	Ch8(CAL)
BlockSize	1024	1024	1024	1024
VResolution	7.6296274E-02	3.8148137E-04	7.6296274E-02	3.8148137E-04
VOffset	0.0000000E+00	0.0000000E+00	0.0000000E+00	0.0000000E+00
VDataType	IS2	IS2	IS2	IS2
VUnit	V	A	V	A
VPlusOverData	?	?	?	?
VMinusOverData	?	?	?	?
VIllegalData	?	?	?	?
VMaxData	32767	32767	32767	32767
VMinData	-32768	-32768	-32768	-32768
HResolution	1.0000000E-06	1.0000000E-06	1.0000000E-06	1.0000000E-06
HOffset	0.0000000E+00	0.0000000E+00	0.0000000E+00	0.0000000E+00
HUnit	s	s	s	s
Date	1999/01/03	1999/01/03	1999/01/03	1999/01/03
Time	20:36:59	20:36:59	20:36:59	20:36:59
\$PrivateInfo				
Form	8.000000e+06			
InputModule	253752	253752	253771	253771
	253752	253752	253771	253771
Mode	NORMAL			
ModelVersion	2.01			

(Note) This header file format is common to many YOKOGAWA measurement instruments. Therefore, even data that are not needed by this instrument (0 data) are included.

**\$PublicInfo (Common information)**

FormatVersion : Version No. of YOKOGAWA's common header file  
Model : Model name  
Endian : Endian mode (Big)<sup>\*1</sup> when the file was saved  
DataFormat : Storage format (Trace)<sup>\*2</sup> of the waveform data of the BINARY file  
GroupNumber : The number of "\$Group" below  
TraceTotalNumber : Total number of saved waveforms  
DataOffset : Start position<sup>\*3</sup> of the waveform data of the BINARY file

**\$Group1 (Group information)**

TraceNumber : The number of waveforms in this group  
BlockNumber : The number of blocks in this group<sup>\*4</sup>  
TraceName : Name of each waveform  
BlockSize : Number of data points of each waveform in one block  
VResolution : The value of coefficient VResolution of the Y-axis converting equation of each waveform<sup>\*5</sup>  
VOffset : The value of coefficient VOffset of the Y-axis converting equation of each waveform<sup>\*5</sup>  
VDataType : Waveform data type of the BINARY file of each waveform<sup>\*6</sup>  
VUnit : The unit used on the Y-axis of each waveform (no influence on the data)  
VPlusOverData : When the BINARY data of each waveform are equal to or greater than this value, the data are erroneous  
VMinusOverData : When the BINARY data of each waveform are equal to or less than this value, the data are erroneous  
VMaxData : Maximum value of the BINARY data of each waveform  
VMinData : Minimum value of the BINARY data of each waveform  
HResolution : The value of coefficient HResolution of the X-axis converting equation of each waveform<sup>\*7</sup>  
HOffset : The value of coefficient HOffset of the X-axis converting equation of each waveform<sup>\*7</sup>  
HUnit : The unit used on the X-axis of each waveform (no influence on the data)  
Date : The date that the trigger occurred  
Time : The time that the trigger occurred

**\$PrivateInfo (Model-specific information)**

ModelVersion : Model version No.  
Form : Internal clock frequency for pulse count  
(Additional information only when the motor module is installed)  
MathBlockNo. : Block No. being computed  
FormMath1 : The waveform of Math1 being computed and its information  
FormMath2 : The waveform of Math2 being computed and its information  
DisplayBlockSize : Data length that is displayed on the screen (display record length)  
DisplayPointNo. : Value indicating where the left end of the display record length lies in the memory (Display offset, the value is equal to 1 when the record length = the display record length)  
PhaseShift : Phase information (advance : -, delay : +)  
PTraceName : Bit information of logic waveforms

For details on \*1 to \*7, see the next page.

## Creation of ASCII Header Files

When waveform data are saved to the floppy disk, the following two files are automatically created in the same directory.

- Waveform data file (\*.WVF)
- ASCII header file (\*.HDR)

Of the two files, only the waveform data file can be loaded by the instrument (However, the ASCII header file (.HDR) must also exist). The ASCII header file that is being described in this section cannot be opened with the instrument. This file can be used when analyzing waveforms on a PC, for example.

\*1 Endian mode when the file was saved

Big : Motorola 68000 series data

\*2 Storage format of the waveform data of the BINARY file

Trace : Format in which blocks are organized for each waveform

\*3 Start position of the waveform data of the BINARY file

The offset from the beginning of the file. This value is always 0 for the PZ4000.

\*4 Maximum number of blocks of a group

When the number of blocks varies for each waveform, this number is the maximum number of blocks. This value is always 1 for the PZ4000.

\*5 Y-axis converting equation of each waveform

Y-axis value = VResolution  $\times$  raw data + VOffset

\*6 Data Type

ISn : n-byte signed integer

IUn : n-byte unsigned integer

FSn : n-byte signed real number

FUn : n-byte unsigned real number

Bm : m-bit data

\*7 X-axis converting equation of each waveform

X-axis value = HResolution  $\times$  raw data + HOffset

# Appendix 6 Float File Format

## For normal measurement mode

- When only power measurement modules are installed

Address	Element 1 Numerical Data	Address	Element 2 Numerical Data	Address	Element 3 Numerical Data	Address	Element 4 Numerical Data	Address	$\Sigma$ A Numerical Data	Address	$\Sigma$ B Numerical Data
0000	Urms	00AC	Urms	0158	Urms	0204	Urms	02B0	Urms	035C	Urms
0004	Umn	00B0	Umn	015C	Umn	0208	Umn	02B4	Umn	0360	Umn
0008	Udc	00B4	Udc	0160	Udc	020C	Udc	02B8	Udc	0364	Udc
000C	Uac	00B8	Uac	0164	Uac	0210	Uac	02BC	Uac	0368	Uac
0010	Irms	00BC	Irms	0168	Irms	0214	Irms	02C0	Irms	036C	Irms
0014	Imn	00C0	Imn	016C	Imn	0218	Imn	02C4	Imn	0370	Imn
0018	Idc	00C4	Idc	0170	Idc	021C	Idc	02C8	Idc	0374	Idc
001C	lac	00C8	lac	0174	lac	0220	lac	02CC	lac	0378	lac
0020	P	00CC	P	0178	P	0224	P	02D0	P	037C	P
0024	S	00D0	S	017C	S	0228	S	02D4	S	0380	S
0028	Q	00D4	Q	0180	Q	022C	Q	02D8	Q	0384	Q
002C	$\lambda$	00D8	$\lambda$	0184	$\lambda$	0230	$\lambda$	02DC	$\lambda$	0388	$\lambda$
0030	$\phi$	00DC	$\phi$	0188	$\phi$	0234	$\phi$	02E0	$\phi$	038C	$\phi$
0034	fU	00E0	fU	018C	fU	0238	fU	02E4	NAN	0390	NAN
0038	fl	00E4	fl	0190	fl	023C	fl	02E8	NAN	0394	NAN
003C	U+pk	00E8	U+pk	0194	U+pk	0240	U+pk	02EC	NAN	0398	NAN
0040	U-pk	00EC	U-pk	0198	U-pk	0244	U-pk	02F0	NAN	039C	NAN
0044	I+pk	00F0	I+pk	019C	I+pk	0248	I+pk	02F4	NAN	03A0	NAN
0048	I-Pk	00F4	I-Pk	01A0	I-Pk	024C	I-Pk	02F8	NAN	03A4	NAN
004C	CfU	00F8	CfU	01A4	CfU	0250	CfU	02FC	NAN	03A8	NAN
0050	Cfl	00FC	Cfl	01A8	Cfl	0254	Cfl	0300	NAN	03AC	NAN
0054	FfU	0100	FfU	01AC	FfU	0258	FfU	0304	NAN	03B0	NAN
0058	Ffl	0104	Ffl	01B0	Ffl	025C	Ffl	0308	NAN	03B4	NAN
005C	Z	0108	Z	01B4	Z	0260	Z	030C	Z	03B8	Z
0060	Rs	010C	Rs	01B8	Rs	0264	Rs	0310	Rs	03BC	Rs
0064	Xs	0110	Xs	01BC	Xs	0268	Xs	0314	Xs	03C0	Xs
0068	Rp	0114	Rp	01C0	Rp	026C	Rp	0318	Rp	03C4	Rp
006C	Xp	0118	Xp	01C4	Xp	0270	Xp	031C	Xp	03C8	Xp
0070	Pc	011C	Pc	01C8	Pc	0274	Pc	0320	Pc	03CC	Pc
0074	$\eta$	0120	$\eta$	01CC	$\eta$	0278	$\eta$	0324	$\eta$	03D0	$\eta$
0078	1/ $\eta$	0124	1/ $\eta$	01D0	1/ $\eta$	027C	1/ $\eta$	0328	1/ $\eta$	03D4	1/ $\eta$
007C	F1	0128	F1	01D4	F1	0280	F1	032C	F1	03D8	F1
0080	F2	012C	F2	01D8	F2	0284	F2	0330	F2	03DC	F2
0084	F3	0130	F3	01DC	F3	0288	F3	0334	F3	03E0	F3
0088	F4	0134	F4	01E0	F4	028C	F4	0338	F4	03E4	F4
008C	$\Delta$ Urms	0138	$\Delta$ Urms	01E4	$\Delta$ Urms	0290	$\Delta$ Urms	033C	NAN	03E8	NAN
0090	$\Delta$ Umn	013C	$\Delta$ Umn	01E8	$\Delta$ Umn	0294	$\Delta$ Umn	0340	NAN	03EC	NAN
0094	$\Delta$ Udc	0140	$\Delta$ Udc	01EC	$\Delta$ Udc	0298	$\Delta$ Udc	0344	NAN	03F0	NAN
0098	$\Delta$ Uac	0144	$\Delta$ Uac	01F0	$\Delta$ Uac	029C	$\Delta$ Uac	0348	NAN	03F4	NAN
009C	$\Delta$ Irms	0148	$\Delta$ Irms	01F4	$\Delta$ Irms	02A0	$\Delta$ Irms	034C	NAN	03F8	NAN
00A0	$\Delta$ Imn	014C	$\Delta$ Imn	01F8	$\Delta$ Imn	02A4	$\Delta$ Imn	0350	NAN	03FC	NAN
00A4	$\Delta$ Idc	0150	$\Delta$ Idc	01FC	$\Delta$ Idc	02A8	$\Delta$ Idc	0354	NAN	0400	NAN
00A8	$\Delta$ lac	0154	$\Delta$ lac	0200	$\Delta$ lac	02AC	$\Delta$ lac	0358	NAN	0404	NAN

### Note

- This format is fixed regardless of the number of modules that are installed. 258 data points (43 functions  $\times$  6 elements) are saved even when there is one module installed.
- The same data are saved for  $\eta$ , 1/ $\eta$ , and F1 to F4 on all elements regardless of whether or not the modules are installed.
- In places where measurement functions are not computed or are NAN, 0x7FC00000 is saved.
- 0x7F800000 and 0xFF800000 are saved when the data values are positive infinity and negative infinity, respectively.



• When power measurement modules and motor module are installed

Address	Element 1 Numerical Data	Address	Element 2 Numerical Data	Address	Element 3 Numerical Data	Address	Element 4 Numerical Data	Address	Σ A Numerical Data	Address	Σ B Numerical Data
0000	Urms	00AC	Urms	0158	Urms	0204	Urms	02B0	Urms	035C	Urms
0004	Umn	00B0	Umn	015C	Umn	0208	Umn	02B4	Umn	0360	Umn
0008	Udc	00B4	Udc	0160	Udc	020C	Udc	02B8	Udc	0364	Udc
000C	Uac	00B8	Uac	0164	Uac	0210	Uac	02BC	Uac	0368	Uac
0010	Irms	00BC	Irms	0168	Irms	0214	Irms	02C0	Irms	036C	Irms
0014	Imn	00C0	Imn	016C	Imn	0218	Imn	02C4	Imn	0370	Imn
0018	Idc	00C4	Idc	0170	Idc	021C	Idc	02C8	Idc	0374	Idc
001C	Iac	00C8	Iac	0174	Iac	0220	Iac	02CC	Iac	0378	Iac
0020	P	00CC	P	0178	P	0224	P	02D0	P	037C	P
0024	S	00D0	S	017C	S	0228	S	02D4	S	0380	S
0028	Q	00D4	Q	0180	Q	022C	Q	02D8	Q	0384	Q
002C	λ	00D8	λ	0184	λ	0230	λ	02DC	λ	0388	λ
0030	φ	00DC	φ	0188	φ	0234	φ	02E0	φ	038C	φ
0034	fU	00E0	FU	018C	fU	0238	fU	02E4	NAN	0390	NAN
0038	fl	00E4	Fl	0190	fl	023C	fl	02E8	NAN	0394	NAN
003C	U+pk	00E8	U+pk	0194	U+pk	0240	U+pk	02EC	NAN	0398	NAN
0040	U-pk	00EC	U-pk	0198	U-pk	0244	U-pk	02F0	NAN	039C	NAN
0044	I+pk	00F0	I+pk	019C	I+pk	0248	I+pk	02F4	NAN	03A0	NAN
0048	I-Pk	00F4	I-Pk	01A0	I-Pk	024C	I-Pk	02F8	NAN	03A4	NAN
004C	CfU	00F8	CfU	01A4	CfU	0250	CfU	02FC	NAN	03A8	NAN
0050	Cfl	00FC	Cfl	01A8	Cfl	0254	Cfl	0300	NAN	03AC	NAN
0054	FfU	0100	FfU	01AC	FfU	0258	FfU	0304	NAN	03B0	NAN
0058	Ffl	0104	Ffl	01B0	Ffl	025C	Ffl	0308	NAN	03B4	NAN
005C	Z	0108	Z	01B4	Z	0260	Z	030C	Z	03B8	Z
0060	Rs	010C	Rs	01B8	Rs	0264	Rs	0310	Rs	03BC	Rs
0064	Xs	0110	Xs	01BC	Xs	0268	Xs	0314	Xs	03C0	Xs
0068	Rp	0114	Rp	01C0	Rp	026C	Rp	0318	Rp	03C4	Rp
006C	Xp	0118	Xp	01C4	Xp	0270	Xp	031C	Xp	03C8	Xp
0070	Pc	011C	Pc	01C8	Pc	0274	Pc	0320	Pc	03CC	Pc
0074	η	0120	η	01CC	η	0278	η	0324	η	03D0	η
0078	1/η	0124	1/η	01D0	1/η	027C	1/η	0328	1/η	03D4	1/η
007C	F1	0128	F1	01D4	F1	0280	F1	032C	F1	03D8	F1
0080	F2	012C	F2	01D8	F2	0284	F2	0330	F2	03DC	F2
0084	F3	0130	F3	01DC	F3	0288	F3	0334	F3	03E0	F3
0088	F4	0134	F4	01E0	F4	028C	F4	0338	F4	03E4	F4
008C	ΔUrs	0138	ΔUrs	01E4	ΔUrs	0290	ΔUrs	033C	Speed	03E8	Speed
0090	Δumn	013C	Δumn	01E8	Δumn	0294	Δumn	0340	Torque	03EC	Torque
0094	ΔUdc	0140	ΔUdc	01EC	ΔUdc	0298	ΔUdc	0344	Sync	03F0	Sync
0098	ΔUac	0144	ΔUac	01F0	ΔUac	029C	ΔUac	0348	Slip	03F4	Slip
009C	Δlrms	0148	Δlrms	01F4	Δlrms	02A0	Δlrms	034C	Pm	03F8	Pm
00A0	Δlmn	014C	Δlmn	01F8	Δlmn	02A4	Δlmn	0350	ηmA	03FC	ηmA
00A4	Δldc	0150	Δldc	01FC	Δldc	02A8	Δldc	0354	ηmB	0400	ηmB
00A8	ΔIac	0154	ΔIac	0200	ΔIac	02AC	ΔIac	0358	NAN	0404	NAN

**Note**

- This format is fixed regardless of the number of modules that are installed. 258 data points (43 functions × 6 elements) are saved even when there is one module installed.
- The same data are saved for η, 1/η, and F1 to F4 on all elements regardless of whether or not the modules are installed.
- In places where measurement functions are not computed or are NAN, 0x7FC00000 is saved.
- 0x7F800000 and 0xFF800000 are saved when the data values are positive infinity and negative infinity, respectively.

**For harmonic measurement mode**

- **When the measurement function is U, I, or P (The measured values of the harmonics and the harmonic distortion factors are saved.)**

Address	Numerical Data	Address	Numerical Data
0000	Measured value Total	—	—
0004	Measured value DC component	07D8	Harmonic distortion factor of the DC component
0008	Fundamental component (1st order)	07DC	Harmonic distortion factor of the fundamental component
000C	2nd order harmonic component	07E0	Harmonic distortion factor of the 2nd order harmonic component
↓	↓	↓	↓
07D4	500th order harmonic component	0FAC	Harmonic distortion factor of the 500th order harmonic component

**Note**

Even if the upper limit of the harmonic order under analysis is less than 500th order, data up to 500th order are saved. The data of the harmonic orders that are not analyzed are saved as NAN (0x7FC00000).

---

- **When the measurement function is other than those indicated above and  $\Sigma$  List as described in the next paragraph (Only the measured values of the harmonics are saved.)**

Address	Numerical Data
0000	Measured value Total
0004	Measured value DC component
0008	Fundamental component (1st order)
000C	2nd order harmonic component
↓	↓
07D4	500th order harmonic component

**Note**

Even if the upper limit of the harmonic order under analysis is less than 500th order, data up to 500th order are saved. The data of the harmonic orders that are not analyzed are saved as NAN (0x7FC00000).

---

- When the measurement function is  $\Sigma$  List
  - For products with firmware version before 2.01

Address	Element 1 Numerical Data	Address	Element 2 Numerical Data	Address	Element 3 Numerical Data	Address	Element 4 Numerical Data	Address	$\Sigma$ A Numerical Data	Address	$\Sigma$ B Numerical Data
0000	Urms	006C	Urms	00D8	Urms	0144	Urms	01B0	Urms	021C	Urms
0004	Irms	0070	Irms	00DC	Irms	0148	Irms	01B4	Irms	0220	Irms
0008	P	0074	P	00E0	P	014C	P	01B8	P	0224	P
000C	S	0078	S	00E4	S	0150	S	01BC	S	0228	S
0010	Q	007C	Q	00E8	Q	0154	Q	01C0	Q	022C	Q
0014	$\lambda$	0080	$\lambda$	00EC	$\lambda$	0158	$\lambda$	01C4	$\lambda$	0230	$\lambda$
0018	$\phi$	0084	$\phi$	00F0	$\phi$	015C	$\phi$	01C8	$\phi$	0234	$\phi$
001C	fU	0088	fU	00F4	fU	0160	fU	01CC	fU	0238	fU
0020	fl	008C	fl	00F8	fl	0164	fl	01D0	fl	023C	fl
0024	Uthd	0090	Uthd	00FC	Uthd	0168	Uthd	01D4	Uthd	0240	Uthd
0028	lthd	0094	lthd	0100	lthd	016C	lthd	01D8	lthd	0244	lthd
002C	Pthd	0098	Pthd	0104	Pthd	0170	Pthd	01DC	Pthd	0248	Pthd
0030	Uthf	009C	Uthf	0108	Uthf	0174	Uthf	01E0	Uthf	024C	Uthf
0034	lthf	00A0	lthf	010C	lthf	0178	lthf	01E4	lthf	0250	lthf
0038	Utif	00A4	Utif	0110	Utif	017C	Utif	01E8	Utif	0254	Utif
003C	ltif	00A8	ltif	0114	ltif	0180	ltif	01EC	ltif	0258	ltif
0040	hvf	00AC	hvf	0118	hvf	0184	hvf	01F0	hvf	025C	hvf
0044	hcf	00B0	hcf	011C	hcf	0188	hcf	01F4	hcf	0260	hcf
0048	NAN	00B4	NAN	0120	NAN	018C	NAN	01F8	$\phi$ U1-U2	0264	$\phi$ U1-U2
004C	NAN	00B8	NAN	0124	NAN	0190	NAN	01FC	$\phi$ U1-U3	0268	$\phi$ U1-U3
0050	NAN	00BC	NAN	0128	NAN	0194	NAN	0200	$\phi$ U1-I1	026C	$\phi$ U1-I1
0054	NAN	00C0	NAN	012C	NAN	0198	NAN	0204	$\phi$ U1-I2	0270	$\phi$ U1-I2
0058	NAN	00C4	NAN	0130	NAN	019C	NAN	0208	$\phi$ U1-I3	0274	$\phi$ U1-I3
005C	F1	00C8	F1	0134	F1	01A0	F1	020C	F1	0278	F1
0060	F2	00CC	F2	0138	F2	01A4	F2	0210	F2	027C	F2
0064	F3	00D0	F3	013C	F3	01A8	F3	0214	F3	0280	F3
0068	F4	00D4	F4	0140	F4	01AC	F4	0218	F4	0284	F4

**Note**

- This format is fixed regardless of the number of modules that are installed or the elements that are specified to be saved. 162 data points (27 functions  $\times$  6 elements) are saved even when there is one module installed.
- The same data are saved for F1 to F4 on all elements regardless of whether or not the modules are installed.
- In places where measurement functions are not computed or are NAN, 0x7FC00000 is saved.
- 0x7F800000 and 0xFF800000 are saved when the data values are positive infinity and negative infinity, respectively.

## Appendix 6 Float File Format

• For products with firmware version 2.01 or later

Address	Element 1 Numerical Data	Address	Element 2 Numerical Data	Address	Element 3 Numerical Data	Address	Element 4 Numerical Data	Address	$\Sigma$ A Numerical Data	Address	$\Sigma$ B Numerical Data
0000	Urms	005C	Urms	00B8	Urms	0114	Urms	0170	Urms	01CC	Urms
0004	Irms	0060	Irms	00BC	Irms	0118	Irms	0174	Irms	01D0	Irms
0008	P	0064	P	00C0	P	011C	P	0178	P	01D4	P
000C	S	0068	S	00C4	S	0120	S	017C	S	01D8	S
0010	Q	006C	Q	00C8	Q	0124	Q	0180	Q	01DC	Q
0014	$\lambda$	0070	$\lambda$	00CC	$\lambda$	0128	$\lambda$	0184	$\lambda$	01E0	$\lambda$
0018	$\phi$	0074	$\phi$	00D0	$\phi$	012C	$\phi$	0188	$\phi$	01E4	$\phi$
001C	Z	0078	Z	00D4	Z	0130	Z	018C	Z	01E8	Z
0020	Xs	007C	Xs	00D8	Xs	0134	Xs	0190	Xs	01EC	Xs
0024	Rs	0080	Rs	00DC	Rs	0138	Rs	0194	Rs	01F0	Rs
0028	Xp	0084	Xp	00E0	Xp	013C	Xp	0198	Xp	01F4	Xp
002C	Rp	0088	Rp	00E4	Rp	0140	Rp	019C	Rp	01F8	Rp
0030	FU	008C	fU	00E8	fU	0144	FU	01A0	FU	01FC	FU
0034	FI	0090	fi	00EC	fi	0148	FI	01A4	FI	0200	FI
0038	Uthd	0094	Uthd	00F0	Uthd	014C	Uthd	01A8	Uthd	0204	Uthd
003C	lthd	0098	lthd	00F4	lthd	0150	lthd	01AC	lthd	0208	lthd
0040	Pthd	009C	Pthd	00F8	Pthd	0154	Pthd	01B0	Pthd	020C	Pthd
0044	Uthf	00A0	Uthf	00FC	Uthf	0158	Uthf	01B4	Uthf	0210	Uthf
0048	lthf	00A4	lthf	0100	lthf	015C	lthf	01B8	lthf	0214	lthf
004C	Utif	00A8	Utif	0104	Utif	0160	Utif	01BC	Utif	0218	Utif
0050	ltif	00AC	ltif	0108	ltif	0164	ltif	01C0	ltif	021C	ltif
0054	hvf	00B0	hvf	010C	hvf	0168	Hvf	01C4	hvf	0220	Hvf
0058	hcf	00B4	hcf	0110	hcf	016C	Hcf	01C8	hcf	0224	Hcf

Address Numerical Data

0228	$\phi$ U1-U2
022C	$\phi$ U1-U3
0230	$\phi$ U1-I1
0234	$\phi$ U1-I2
0238	$\phi$ U1-I3
023C	F1
0240	F2
0244	F3
0248	F4
024C	Speed
0250	Torque
0254	Sync
0258	Pm
025C	$\eta$ mA
0260	$\eta$ mB

**Note**

- This format is fixed regardless of the number of modules that is installed or elements specified for storage. Even when the number of installed modules is 1, 153 data points are saved. However, when the motor module is not installed, NAN (0x7FC00000) is saved to the positions between Speed and  $\eta$ mB.
- 0x7FC00000 is saved in measurement function positions that are NAN or are not being computed.
- When the data value is equal to positive infinity, 0x7F800000 is saved; when the data value is negative infinity, 0xFF800000 is saved.

# Appendix 7 Power Basics (Power/Harmonics/Three Constants Related to the AC Circuit)

This section describes the basic concepts of power, harmonics, and the three constants related to the AC circuit.

## Power

Electrical energy is transformed and used in different forms such as heat in an electric heater or an electric furnace, rotational power to drive motors, and light in fluorescent and mercury lamps. Power (electric power) represents the amount of work that the electricity (electrical energy) performs on these types of loads over a unit amount of time. The unit of power is W (watts). When 1 joule of work is done over a period of 1 second, the electrical power is equal to 1 W.

### DC power

DC power  $P[W]$  can be determined by the product of the applied voltage  $U(V)$  and the current  $I[A]$ .

$$P = UI [W]$$

In the following figure, electrical energy indicated in the above equation is taken from the power source and dissipated at  $R[\Omega]$  (load).

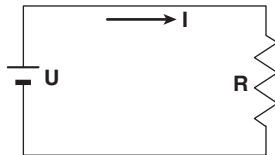

### AC (alternating current)

The electricity supplied by the power company is an alternating current. The waveform is sinusoidal. The amplitude of an AC signal can be expressed in terms of the instantaneous values, maximum values, rms values, and mean values. In general, it is expressed in terms of rms values.

The instantaneous value of the current of a sine wave,  $i$ , is expressed as  $I_m \sin \omega t$  ( $I_m$  : max. value of current,  $\omega$  : angular velocity where  $\omega = 2\pi f$ ,  $f$  : frequency of the AC signal). The heating effect of the AC signal is proportional to  $i^2$  and varies as shown in the following figure.

\* Refers to the electrical energy being converted to heat energy due to current flowing through the resistor.

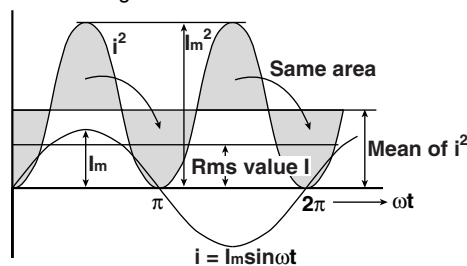

### Rms value (effective value)

The rms value (effective value) is the value of the DC signal that generates the same heating effect as the AC signal. If the value of the DC signal that generates the same heating effect is expressed as  $I$ , then

$$I = \sqrt{\text{Mean over one period of } i^2} = \sqrt{\frac{1}{2\pi} \int_0^{2\pi} i^2 d\omega t} = \frac{I_m}{\sqrt{2}}$$

Because this value is equal to the square root of the mean of the square of the instantaneous values ( $i$ ) over one period (in short, rms), the symbol "rms" is generally used to denote the effective value.

## Appendix 7 Power Basics (Power/Harmonics/Three Constants Related to the AC Circuit)

---

For the mean value, since taking the average over one period of a sine wave results in zero, the mean is determined using the absolute value over one period of the signal. As with the rms value, if the mean value of the current of the instantaneous value  $i = I_m \sin \omega t$  is expressed as  $I_{mn}$ , then,

$$I_{mn} = \text{Mean over one period of } |i| = \frac{1}{2\pi} \int_0^{2\pi} |i| d\omega t = \frac{2}{\pi} I_m$$

This relationship is the same for the voltage of the sine wave.

The maximum value, rms value, and mean value of an AC sine wave are related in the following way. These values are used to calculate the crest factor and the form factor which are used to determine the trend of an AC signal.

$$\text{Crest factor} = \frac{\text{Maximum value}}{\text{Rms value}}$$

$$\text{Form factor} = \frac{\text{Rms value}}{\text{Mean value}}$$

**Vector Display of an AC signal**

In general, the instantaneous values of voltage and current are expressed by the following equations.

Voltage :  $u = U_m \sin \omega t$

Current :  $i = I_m \sin(\omega t - \phi)$

The time offset of the voltage and current is called the phase difference, and  $\phi$  is called the phase angle. This time offset is mainly created by the load that is supplied with power. In general, when there is only resistance in the load, the phase difference is zero; when there is inductance (coil) in the load, the current lags behind the voltage; when there is capacitance in the load, the current leads the voltage.

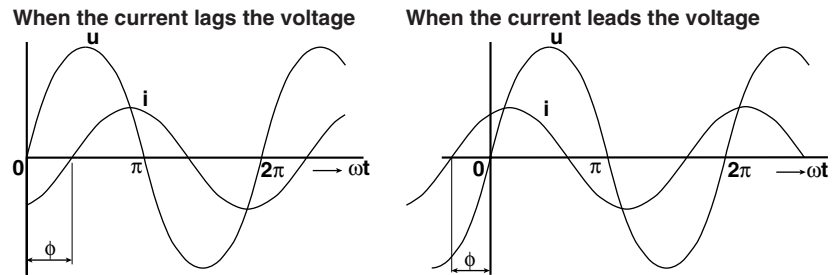

The vector display is used to show the amplitude and phase relationships of the voltage and current. Taking the positive vertical axis to be the reference, an angle in the counter clockwise direction is taken to be positive.

To clearly indicate that the graph is showing a vector, a dot is placed on the top of the symbol representing the value. The amplitude of the vector represents the rms value.

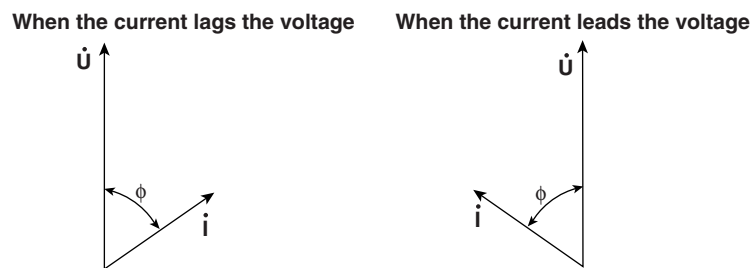

The vector display of the voltage and current of a three-phase AC signal would look something like the following figure.

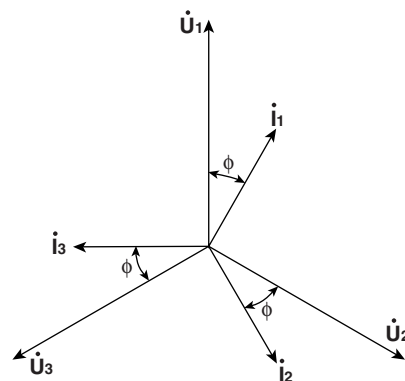

**AC power**

Because a phase difference depending on the load exists between the voltage and current, AC power is not as easily determined as DC power.

When the instantaneous voltage is  $u = U_m \sin \omega t$  and the instantaneous current is  $i = I_m \sin(\omega t - \phi)$ , the instantaneous power,  $p$ , is

$$p = u \times i = U_m \sin \omega t \times I_m \sin(\omega t - \phi) = UI \cos \phi - UI \cos(2\omega t - \phi)$$

where  $U$  and  $I$  represent the rms values of the voltage and current, respectively.

$p$  becomes the sum of the time-independent term, " $UI \cos \phi$ " and the AC component of twice the frequency of the voltage or current, " $-UI \cos(2\omega t - \phi)$ ."

The mean value of power over one period is called the AC power. Taking the mean over one period, the AC power,  $P$ , becomes

$$P = UI \cos \phi \text{ [W]}$$

The power varies depending on the phase difference,  $\phi$ , even when the voltage and current are the same. As shown in the figure below, the section above the horizontal axis represents positive power (power supplied to the load) and the section below the horizontal axis represents negative power (power delivered from the load). The difference between the two is the power dissipated by the load. As the phase difference between the voltage and current increases, negative power increases. At  $\phi = \pi/2$ , the positive and negative powers become equal and no power is dissipated in the load.

**When the phase difference between the voltage and current is 0**

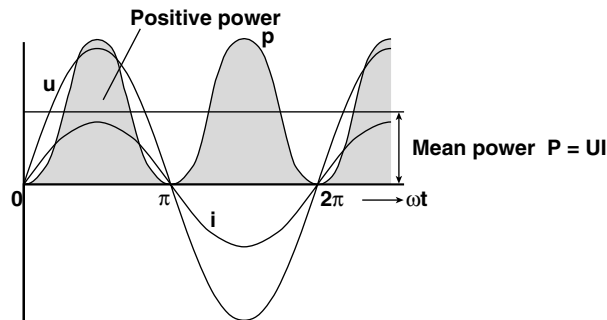

**When the phase difference between the voltage and current is  $\phi$**

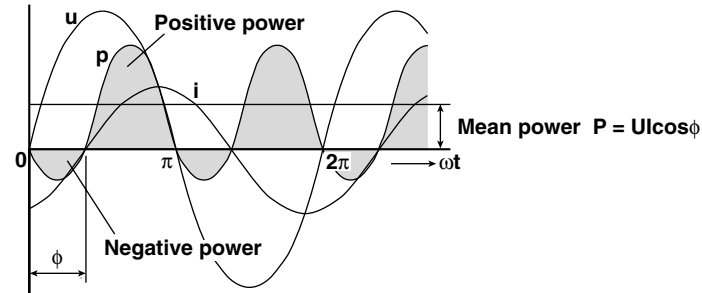

**When the phase difference between the voltage and current is  $\frac{\pi}{2}$**

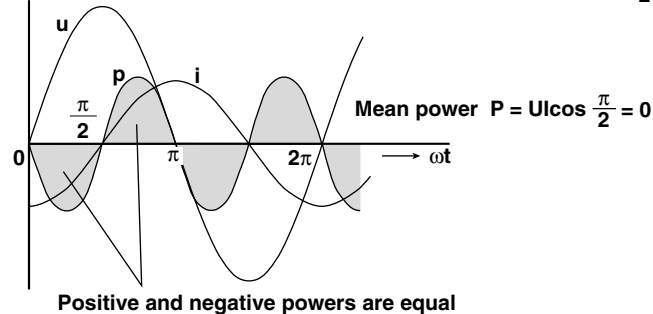



**Active power and the power factor**

Not all of the power represented by the product of the voltage and current,  $UI$ , is dissipated. The product,  $UI$ , is called the apparent power ( $S$ ). The unit is VA (volt-ampere). Apparent power is used to express the electrical capacity of the devices that run under AC power.

Of the apparent power, the true power that is dissipated by the device is called the active power or effective power ( $P$ ). This power is the same as the AC power described earlier.

$$S = UI \text{ [VA]}$$

$$P = UI\cos\phi \text{ [W]}$$

$\cos\phi$  represents the ratio of the true power with respect to the apparent power and this ratio is called the power factor ( $\lambda$ ).

**Reactive power**

When the current  $I$  lags the voltage  $U$  by  $\phi$ , the component of the power in the same direction as the voltage  $U$  is expressed as  $I\cos\phi$  and the component of the power perpendicular to the voltage  $U$  is expressed as  $I\sin\phi$ . The active power  $P=UI\cos\phi$  is the product of the voltage  $U$  and the current component  $I\cos\phi$ . Conversely, the product of the voltage  $U$  and the current component  $I\sin\phi$  is called reactive power ( $Q$ ) and its unit is var.

$$Q = UI\sin\phi \text{ [var]}$$

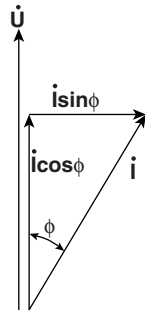

Apparent power  $S$ , active power  $P$ , and reactive power  $Q$  are related in the following way.

$$S^2 = P^2 + Q^2$$

## **Harmonics**

Harmonics are sine waves that have frequencies that are integer multiples of the frequency of a fundamental signal (generally a 50/60-Hz sinusoid in the field of power). The current power that flows through the power rectification circuit, phase control circuit, and other circuits that are used in various electrical devices, generates harmonic voltages and currents on the power line. When the fundamental signal and harmonic signals are combined, the waveform is distorted, and this can cause interference to devices that are connected to the power line.

### **Terminology**

The following terms are related to harmonics.

- **Fundamental wave (fundamental component)**  
Periodic complex waves are divided into different sinusoid groups. The fundamental wave is the signal with the longest period. It is the sinusoid that has the fundamental frequency among the periodic complex wave.
- **Fundamental frequency**  
This is the frequency corresponding to the period of the periodic complex wave. It is the frequency of the fundamental wave.
- **Distorted wave**  
The distorted wave has a waveform that is different from the fundamental wave.
- **Higher harmonic**  
Sinusoids that have frequencies that are integer multiples (2 or greater) of the fundamental frequency.
- **Harmonic component**  
The signal component of the waves that have frequencies that are integer multiples (2 or greater) of the fundamental frequency.
- **Harmonic distortion factor**  
The ratio of the rms value of the nth harmonic signal contained in the distorted waveform to the rms value of the fundamental signal or total signal.
- **Harmonic order**  
The integer ratio of the harmonic frequency with respect to the fundamental frequency.
- **Total harmonic distortion**  
The ratio of the rms value of all harmonics to the rms value of the fundamental signal or total signal.

**Interference caused by harmonic signals**

Harmonic signals adversely affect electric devices and facilities. The following are some examples.

- Phase advance capacitor or series reactor  
The reduction of circuit impedance caused by the harmonic current causes excessive current to flow resulting in vibration, humming, overheating, and burnouts.
- Cable  
Overheating of the neutral conductor caused by harmonic currents flowing through it in a three-phase four-wire system.
- Potential transformer  
Causes magnetostrictive noise of the iron core which leads to increased iron and copper losses.
- Breaker and fuse  
Erroneous operation caused by excessive harmonic current. Causes fuse to blow.
- Communication  
Causes noise voltage from electro-magnetic induction.
- Control device  
Erroneous operation caused by distorted control signals.
- Audio-visual equipment  
Deterioration of performance and life span. Flicker caused by video noise. Malfunction of parts.

### Three Constants Related to the AC Circuit

#### Resistance

Current  $i$  when the instantaneous value of  $u = U_m \sin \omega t$  of AC voltage is applied to load resistor  $R[\Omega]$  is expressed by the following equation.  $I_m$  denotes the maximum value of the current.

$$i = \frac{U_m}{R} \sin \omega t = I_m \sin \omega t$$

If expressed in terms of the rms value, the equation becomes  $I = U / R$ .

The current flowing through a resistive circuit has no phase difference with respect to the voltage.

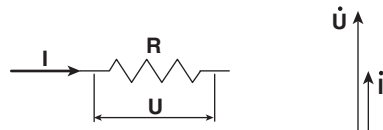

#### Inductance

Current  $i$  when the instantaneous value of  $u = U_m \sin \omega t$  of AC voltage is applied to the load inductance  $L[H]$  is expressed by the following equation.

$$i = \frac{U_m}{X_L} \sin \left( \omega t - \frac{\pi}{2} \right) = I_m \sin \left( \omega t - \frac{\pi}{2} \right)$$

If expressed in terms of the rms value, the equation becomes  $I = U / X_L$  where  $X_L = \omega L$ .  $X_L$  is called inductive reactance and its unit is  $\Omega$ .

Inductance has the effect of inhibiting the current from changing, and consequently the current phase lags that of the voltage.

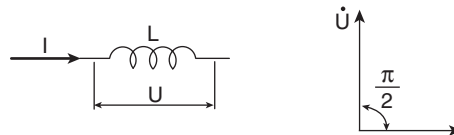

#### Static capacitance

Current  $i$  when the instantaneous value of  $u = U_m \sin \omega t$  of AC voltage is applied to the load capacitance  $C[F]$  is expressed by the following equation.

$$i = \frac{U_m}{X_C} \sin \left( \omega t + \frac{\pi}{2} \right) = I_m \sin \left( \omega t + \frac{\pi}{2} \right)$$

If expressed in terms of the rms value, the equation becomes  $I = U / X_C$ , where  $X_C = 1 / \omega C$ .  $X_C$  is called capacitive reactance and its unit is  $\Omega$ .

When the polarity of the voltage changes, the maximum charge current that has the same polarity as the voltage flows through the capacitor. When the voltage decreases, discharge current that has the opposite polarity as the voltage flows through the capacitor. Thus, the current phase advances with respect to the voltage.

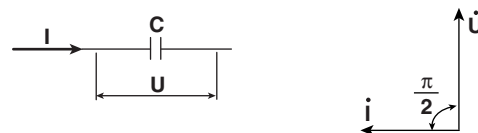

**R, L, C series circuit**

The voltage when resistance  $R_s[\Omega]$ , inductance  $L[H]$ , and static capacitance  $C[F]$  are connected in series is expressed by the following equation.

$$\begin{aligned}
 U &= \sqrt{(U_{R_s})^2 + (U_L - U_C)^2} = \sqrt{(IR_s)^2 + (IX_L - IX_C)^2} \\
 &= I\sqrt{(R_s)^2 + (X_L - X_C)^2} = I\sqrt{R_s^2 + X_s^2} \\
 I &= \frac{U}{\sqrt{R_s^2 + X_s^2}}, \quad \phi = \tan^{-1} \frac{X_s}{R_s}
 \end{aligned}$$

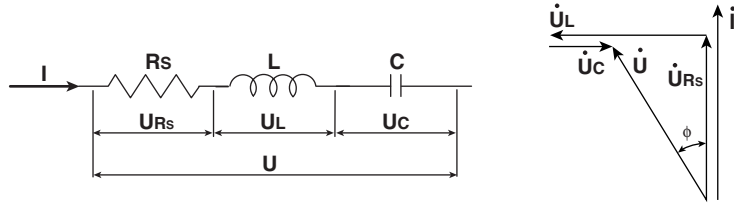

The relationships between resistance  $R_s$ , reactance  $X_s$ , and impedance  $Z$  are expressed as follows :

$$\begin{aligned}
 X_s &= X_L - X_C \\
 Z &= \sqrt{R_s^2 + X_s^2}
 \end{aligned}$$

**R, L, C parallel circuit**

The current when resistance  $R_P[\Omega]$ , inductance  $L[H]$ , and static capacitance  $C[F]$  are connected in parallel is expressed by the following equation.

$$\begin{aligned}
 I &= \sqrt{(I_{R_P})^2 + (I_L - I_C)^2} = \sqrt{\left(\frac{U}{R_P}\right)^2 + \left(\frac{U}{X_L} - \frac{U}{X_C}\right)^2} \\
 &= U \sqrt{\left(\frac{1}{R_P}\right)^2 + \left(\frac{1}{X_L} - \frac{1}{X_C}\right)^2} = U \sqrt{\left(\frac{1}{R_P}\right)^2 + \left(\frac{1}{X_P}\right)^2} \\
 U &= \frac{I R_P X_P}{\sqrt{R_P^2 + X_P^2}}, \quad \phi = \tan^{-1} \frac{R_P}{X_P}
 \end{aligned}$$

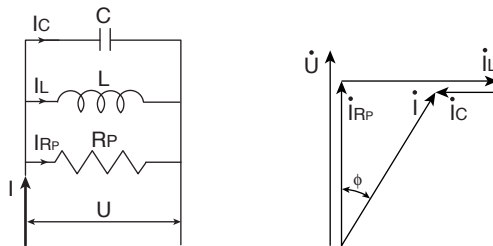

The relationship between resistance  $R_P$ , reactance  $X_P$ , and impedance  $Z$  are expressed as follows :

$$\begin{aligned}
 X_P &= \frac{X_L X_C}{X_C - X_L} \\
 Z &= \frac{R_P X_P}{\sqrt{R_P^2 + X_P^2}}
 \end{aligned}$$

# Index

## Symbols

1P2W .....	3-13
1P3W .....	3-13
3P3W .....	3-14
3P3W>3V3A .....	10-9
3P4W .....	3-14
3V3A .....	3-14

## A

A/D converter .....	1-3
ABORT .....	4-4
Abort .....	12-12
AC circuit .....	App-25
AC component .....	1-6
AC power .....	App-28
accessory .....	iii, v
ACQ .....	6-3
acquisition memory .....	1-4
active power .....	App-29
aliasing .....	1-27
Allocation .....	9-19
amplitude axis .....	1-26
analog .....	15-4
analog input .....	15-1
apparent power .....	1-34
ASCII header .....	App-16
attenuation constant .....	10-19
attribute .....	12-31
auto naming .....	12-14
auto range .....	1-13, 5-10, 5-18
auto scaling .....	11-7
averaging .....	1-35, 10-19
AVG .....	1-38

## B

Bar .....	9-31
bar graph display .....	1-32, 2-12
Bar Item No. ....	9-29
Bar Setting .....	9-29
block diagram .....	1-2
brightness .....	14-3
built-in printer .....	13-1, 17-11

## C

CAL .....	4-6
capacitance .....	3-9, App-32
center level .....	7-10
centronics interface .....	13-10, 17-11
channel .....	1-12
color (external printer) .....	13-10
color (screen image) .....	13-13
command type (external printer) .....	13-10
comment .....	12-14, 13-7
complex function .....	1-40
compression .....	13-13
computation .....	1-34, 1-37
computation region .....	11-3
computed point .....	11-9
Condition .....	7-8

Config .....	14-2
connecting .....	3-11, 3-15
converting the scale .....	11-7
copy (file) .....	12-36
corrected power .....	1-36
corrective action .....	16-1
creating a directory .....	12-40
crest factor .....	App-26
CT .....	1-13
CT ratio .....	5-24
current input terminal .....	2-14
current range .....	5-10
current sensor input connector .....	2-14
current sensor range .....	5-18
current sensor transformation ratio .....	5-18
cursor .....	1-41, 10-3
cursor measurement .....	1-41
cursor measurement display .....	2-12
cursor setting .....	1-10, 10-6

## D

data format .....	13-13
data size (numerical data) .....	12-26
data size (screen image) .....	13-13
data size (setup parameter) .....	12-14
data size (waveform data) .....	12-20
data type (numerical data) .....	12-26
data type (waveform data) .....	12-20
date and time .....	3-26
decreasing (range) .....	5-10
delay .....	7-13
delay time .....	1-21
deleting .....	12-31
delta computation .....	1-34, 10-9
$\Delta$ Measure .....	10-8
Delta>Star .....	10-10
determination of delta computation .....	App-8
determination of measurement function .....	App-4
Dir Name .....	12-39
disk .....	12-8
DISPLAY .....	8-2
display channel .....	9-4
display format .....	8-6, 9-4, 9-31
display interpolation .....	1-28
display order (numerical data) .....	App-14
display record length .....	1-15
Display Resolution .....	8-1
display scaling .....	1-39
displayed digit .....	1-11
displayed item .....	8-6
displayed point .....	1-27
distorted wave .....	App-30
dividing the record length .....	1-16, 6-4
division (screen) .....	9-9
dual list .....	2-9, 8-17

## E

edge trigger .....	1-18, 7-7
efficiency .....	1-6
EIA-232 .....	17-11
EIA-574 .....	17-11

## Index

element ..... 1-12  
entering string ..... 4-1  
entering value ..... 4-1  
equation (apparent power) ..... 1-34, 10-17  
equation (corrected power) ..... 10-17  
equation (distortion factor) ..... 1-36  
equation (user-defined function) ..... 10-13  
equation (waveform computation) ..... 11-6  
error message ..... 16-2  
 $\eta$ mA ..... 15-20  
 $\eta$ mB ..... 15-20  
expanding ..... 9-21  
exponentially averaging ..... 1-35, 1-38  
Ext Trigger ..... 10-4  
extension (numerical data) ..... 12-26  
extension (screen image) ..... 13-13  
extension (setup parameter) ..... 12-14  
extension (waveform data) ..... 12-20  
external clock ..... 6-5, 17-1  
external dimension (253710) ..... 17-14  
external dimension (253751) ..... 17-19  
external dimension (253752) ..... 17-24  
external dimension (253771) ..... 17-26  
external trigger ..... 14-1  
external trigger input ..... 17-10  
external trigger output ..... 17-10  
external trigger setting ..... 1-11, 10-7

## F

falling ..... 1-10, 7-7  
fast fourier transform ..... 1-40  
FFT ..... 1-40  
FFT Points ..... 11-8  
FFT Window ..... 11-8  
FILE ..... 12-5  
File ..... 13-11  
file attribute ..... 12-31  
File List ..... 12-11  
file name ..... 12-14  
Filter ..... 12-12  
fixed range ..... 1-13, 5-10, 5-18  
floppy disk ..... 12-8  
form factor ..... App-26  
format ..... 12-6, 13-8, 13-13  
Format Type ..... 12-7  
Freq Range ..... 15-4  
frequency input range (revolution sensor) ..... 15-7  
frequency measurement source ..... 15-17  
front panel ..... 2-1  
fundamental component ..... App-30  
fundamental frequency ..... 1-16, 17-9, App-30  
fundamental wave ..... App-30  
fuse ..... 16-9

## G

GP-IB interface ..... 17-10  
graphics color ..... 14-6  
graticule ..... 1-33, 9-12

## H

hanning window ..... 1-40, 11-9  
Harm Item No. .... 8-13  
harmonic distortion factor ..... App-30  
harmonic measurement mode ..... 1-7  
harmonic order ..... App-30

harmonics ..... App-25, App-30  
HELP ..... 4-8  
higher harmonic ..... App-30  
holder ..... 16-9  
horizontal axis ..... 1-26

## I

I Range ..... 5-7, 5-9, 5-14  
i1-i2 ..... 10-9  
increasing (range) ..... 5-10  
inductance ..... App-32  
Information ..... 16-8  
initial setting list ..... App-10  
Initializing ..... 4-3  
INPUT ..... 5-6  
input filter ..... 1-14  
input module ..... iv, 2-14  
input range (revolution sensor) ..... 15-6  
input range (torque meter) ..... 15-8  
installation condition ..... 3-2  
installation position ..... 3-3  
installing (input module) ..... 3-4  
internal clock ..... 6-5  
interpolation ..... 1-28, 9-10  
isolation sensor ..... 3-16  
Item Amount ..... 8-4, 8-13

## J

jog shuttle ..... 2-3

## K

key testing ..... 16-7  
keyboard testing ..... 16-7

## L

label ..... 1-33, 9-16  
label name ..... 9-17  
lag ..... 1-35  
language ..... 14-2  
LCD Brightness ..... 14-2  
lead ..... 1-35  
level ..... 7-6  
line filter ..... 1-14, 5-27  
list display ..... 1-24, 8-16  
lock release lever ..... 13-2

## M

MakeDir ..... 12-39  
manual scaling ..... 11-7  
mapping ..... 9-9  
marker ..... 1-41, 9-31  
marker jump ..... 11-19  
MATH ..... 11-1  
MEASURE ..... 10-2  
measurement function ..... 1-5, 1-7  
measurement function (harmonic measurement mode) ... 17-4  
measurement function (normal measurement mode) ..... 17-2  
measurement item ..... 17-2  
measurement mode ..... 1-5, 5-1  
measurement range ..... 1-13  
measurement/computation period ..... 1-10  
Media Info ..... 12-7

medium ..... 12-14  
memory testing ..... 16-7  
message ..... 16-2  
message language ..... 14-3  
Min Order ..... 10-22  
MISC ..... 12-3, 14-2, 16-5  
Mode ..... 5-1, 7-1, 9-19  
model ..... 16-8  
model code ..... ii  
module configuration ..... 16-8  
motor efficiency ..... 15-20  
motor evaluation ..... 15-1  
motor module ..... 15-3  
motor output ..... 15-19  
motor's number of poles ..... 15-17

## N

normal measurement mode ..... 1-5  
NULL function ..... 1-17  
number of displayed item ..... 8-16  
number of poles ..... 15-17  
Numeric ..... 8-6, 12-22  
Numeric Disp Item ..... 8-4, 8-13  
Numeric+Bar ..... 8-6  
Numeric+Wave ..... 8-6  
numerical computation ..... 1-34  
numerical computation mode ..... 10-5  
numerical data ..... 1-5, 1-7  
numerical display (harmonic measurement mode) .... 1-23, 2-8  
numerical display (normal measurement mode) ..... 1-22, 2-6

## O

observation time ..... 1-15, 6-2, App-1  
ON/OFF the waveform display ..... 1-28  
OP AMP ..... 1-3  
operating altitude ..... 17-12  
operating condition ..... 17-12  
operation key ..... 2-3  
operator (user-defined function) ..... 10-14  
operator (waveform computation) ..... 11-6  
option ..... ii, 16-8  
optional accessory ..... v  
order under analysis ..... 10-23  
output command type (external printer) ..... 13-10  
Own ID ..... 12-3

## P

P-P compression ..... 1-27  
Page Down Scroll Exec ..... 8-15  
page scrolling ..... 8-18  
Page Up Scroll Exec ..... 8-15  
paper feeding ..... 13-4  
paper roll ..... 13-2  
parallel circuit ..... App-33  
partition ..... 12-9  
Pc Formula ..... 10-16  
period ..... 10-5  
phase difference ..... 1-35, 10-21  
photo isolator ..... 1-4  
pin no. .... 12-2  
PLL source ..... 1-9, 6-8  
Pm ..... 15-18  
Pole ..... 15-16  
position ..... 7-11

post-trigger ..... 1-21  
power basic ..... App-25  
power coefficient ..... 1-14, 5-24  
power consumption ..... 17-12  
power factor ..... App-29  
power fuse ..... 16-9  
power loss ..... 3-8  
power measurement module ..... 2-14  
Power Module ..... 5-6, 5-14, 5-20, 5-25  
power range ..... 1-13, 5-11  
power spectrum ..... 1-40  
power switch ..... 3-23  
pre-trigger ..... 1-21  
precaution ..... 3-6  
printer cover ..... 13-2  
problem ..... 16-1  
property ..... 12-15  
PT ..... 1-13  
PT ratio ..... 5-24  
pulse ..... 15-4  
pulse count ..... 15-13  
pulse input ..... 15-1

## R

R ..... 12-31  
R/W ..... 12-31  
rack mount ..... 3-3  
range ..... 5-10  
rated supply voltage ..... 17-12  
rated supply voltage frequency ..... 17-12  
re-computing (numerical data) ..... 1-36, 10-7  
re-computing (waveform) ..... 1-41  
reactive power ..... App-29  
rear panel ..... 2-1  
Rec Division ..... 6-3  
record length ..... 1-15, 6-4, App-1  
rectangular window ..... 1-40, 11-9  
rectified mean value calibrated to the rms value ..... 1-6  
reducing ..... 9-21  
release arm ..... 13-2  
removing (input module) ..... 3-4  
Rename ..... 12-38  
replacement part ..... 16-10  
replacement period ..... 16-10  
resetting (displayed item) ..... 8-7  
resetting (numerical display) ..... 1-25  
resetting (order of the displayed item) ..... 8-17  
resolution ..... 8-1  
revolution sensor signal input channel ..... 15-1  
revolution sensor signal type ..... 15-6  
rising ..... 1-10, 7-7  
roll chart ..... 13-2  
roller ..... 13-2  
ROM version ..... 16-8  
rotary knob ..... 2-3, 6-1  
rotating speed ..... 15-13  
RS-232 ..... 17-11

## S

S Formula ..... 10-15  
sampled data ..... 1-12  
sampling rate ..... App-1  
Scale Value ..... 9-14  
scaling ..... 1-13, 5-20  
scaling factor ..... 5-24  
scaling factor (motor output) ..... 15-19



## Index

scaling factor (revolution sensor) ..... 15-13  
scaling factor (torque) ..... 15-15  
scaling function ..... 5-24  
screen ..... 2-6  
scrolling ..... 8-7, 8-17  
SCSI ..... 17-11  
SCSI ID ..... 12-3  
SCSI specification ..... 12-2  
Selecting (current sensor range) ..... 5-18  
selecting (measurement mode) ..... 5-1  
selecting (wiring method) ..... 5-2  
self-test ..... 16-5  
Sense Type ..... 15-4  
Sensor Range ..... 5-17  
Sensor Ratio(mV/A) ..... 5-15, 5-18  
serial interface ..... 17-11  
series circuit ..... App-33  
Set/Reset ..... 12-29  
SETUP ..... 5-1  
Setup ..... 12-10  
signal flow ..... 1-3  
signal type (revolution sensor) ..... 15-6  
 $\Sigma$  list ..... 2-9, 8-18  
 $\Sigma$ function ..... 1-5, 1-8, App-7  
simple average ..... 1-6  
simultaneous display ..... 2-13  
single list ..... 2-9, 8-17  
SINGLE START ..... 4-4  
Slip ..... 15-17  
slope ..... 1-10, 7-6  
Source ..... 7-3  
spare part ..... v  
Speed ..... 15-3, 15-11  
split screen ..... 1-28  
standard accessory ..... iii  
standard operating condition ..... 17-12  
Star>Delta ..... 10-10  
START/STOP ..... 4-4  
static capacitance ..... App-32  
storage environment ..... 17-12  
storage location ..... 3-2  
stray capacitance ..... 3-9  
suffix code ..... ii  
symbol ..... vi  
symbol of measurement function ..... App-4  
Sync Source ..... 10-2  
synchronous speed ..... 15-17  
system condition ..... 16-8  
system configuration ..... 1-1

## T

Terminal ..... 5-7, 5-9, 5-14, 5-17  
text color ..... 14-7  
Thd Formula ..... 10-24  
three constants ..... App-25  
time ..... 3-26  
time axis ..... 1-26  
time base ..... 1-16, 6-5  
time window ..... 1-40, 11-9  
TINTG ..... 1-37  
Torque ..... 15-4, 15-14, 15-15  
torque meter signal input channel ..... 15-1  
total efficiency ..... 15-20  
total harmonic distortion ..... App-30  
Trace ..... 12-17  
Trace Label ..... 9-17  
TREND ..... 1-37

trigger delay ..... 1-21, 7-14  
trigger level ..... 1-18, 7-7  
trigger mode ..... 1-19, 7-2  
trigger output ..... 14-1  
trigger position ..... 1-21, 7-12  
trigger slope ..... 1-18, 7-7  
trigger source ..... 1-18, 7-4  
trigger type ..... 1-18, 7-7  
troubleshooting ..... 16-1  
true rms value ..... 1-5  
Type ..... 7-6

## U

U Range ..... 5-6, 5-9  
u1-u2 ..... 10-9  
update rate ..... 17-1  
Upper limit of harmonic order under analysis ..... 17-9  
User Color ..... 14-5, 14-6  
User Defined ..... 10-11  
user-defined function ..... 1-34, 10-12

## V

V Zoom ..... 9-18  
vector display ..... 1-31, 2-11, 9-25  
vector display of an AC signal ..... App-27  
vertical axis ..... 1-26  
voltage input terminal ..... 2-14  
voltage range ..... 5-10

## W

Wave ..... 9-4, 12-16  
Wave Display ..... 9-3  
Wave Setting ..... 9-3, 9-7  
Wave+Bar ..... 9-4  
waveform analysis ..... 1-37  
waveform computation ..... 1-37  
waveform computation mode ..... 11-3  
waveform display ..... 2-10  
waveform label ..... 1-33  
waveform mapping ..... 9-9  
window trigger ..... 1-18, 7-10  
window width ..... 7-10  
wiring ..... 3-11, 3-15, 5-2  
wiring example (current sensor) ..... 3-17  
wiring example (directly) ..... 3-13  
wiring example (exceeding 600 V) ..... 3-22  
wiring example (PT or CT) ..... 3-20  
wiring method ..... 1-11, 3-12, 5-2  
wiring precaution ..... 3-6

## Z

zero crossing ..... 10-6  
zero crossing detector ..... 1-3  
zero crossing filter ..... 1-14, 5-27  
zero crossing setting ..... 1-10  
zero input line ..... 1-26  
zero level ..... 1-10  
zero level compensation ..... 1-17, 4-6  
zoom box ..... 1-30  
zoom display ..... 2-10  
zoom factor ..... 9-22  
Zoom Format ..... 9-19  
zoom position ..... 1-30, 9-23  
zooming ..... 1-29, 9-21